

***myprojectorlamps.com***

**The most trusted, dependable name  
in projector lamp sales.**



<http://www.myprojectorlamps.com>



<http://www.myprojectorlamps.ca>



<http://www.myprojectorlamps.eu>

The following projector manual has not been modified or altered in any way.

**BenQ**

CP120 Digital Projector

Commuter Series

User's Manual

Welcome

# Copyright

Copyright 2005 by BenQ Corporation. All rights reserved. No part of this publication may be reproduced, transmitted, transcribed, stored in a retrieval system or translated into any language or computer language, in any form or by any means, electronic, mechanical, magnetic, optical, chemical, manual or otherwise, without the prior written permission of BenQ Corporation.

# Disclaimer

BenQ Corporation makes no representations or warranties, either expressed or implied, with respect to the contents hereof and specifically disclaims any warranties, merchantability or fitness for any particular purpose. Further, BenQ Corporation reserves the right to revise this publication and to make changes from time to time in the contents hereof without obligation to notify any person of such revision or changes.

\*DLP, Digital Micromirror Device and DMD are trademarks of Texas Instruments. Others are copyrights of their respective companies or organizations.

# Software license agreement

## **SOFTWARE LICENSE AGREEMENT FOR BenQ Products:**

- Wireless Wizard

**IMPORTANT READ CAREFULLY:** This BenQ Software License Agreement ("SLA") is a legal agreement between you (either an individual or a single entity) and BenQ Corporation ("BenQ") for the BenQ SOFTWARE PRODUCT identified above, which includes computer software and associated media and printed materials, and may include online or electronic documentation ("SOFTWARE PRODUCT" or "SOFTWARE"). By installing, copying, or otherwise using the SOFTWARE PRODUCT, you agree to be bound by the terms of this SLA.

## **SOFTWARE PRODUCT LICENSE:**

The SOFTWARE PRODUCT is protected by copyright laws and international copyright treaties, as well as other intellectual property laws and treaties. The SOFTWARE PRODUCT is licensed, not sold.

### **1. GRANT OF LICENSE.**

This SLA grants you the rights to install, use, access, or otherwise interact with ("RUN") ONE copy of the SOFTWARE per computer used in conjunction with the BenQ hardware product which it is designed to work with.

### **2. CONDITIONS.**

You may not modify, reverse engineer, decompile, or disassemble the SOFTWARE PRODUCT.

The SOFTWARE PRODUCT is licensed as a single product. Its component parts may not be separated for use.

You may permanently transfer all of your rights under this SLA, provided you retain no copies, you transfer all of the SOFTWARE PRODUCT and the associated hardware (including all component parts, the media and printed materials, any upgrades, this SLA) and the recipient agrees to the terms of this SLA.

### **3. TERMINATION.**

Without prejudice to any statutory or other rights you may have, BENQ may terminate this SLA if you fail to comply with the terms and conditions of this SLA. In such event, you must destroy all copies of the SOFTWARE PRODUCT and all of its component parts.

#### **4. COPYRIGHT.**

All rights, title and interest, including all copyrights and other intellectual property and proprietary rights, in and to the SOFTWARE PRODUCT (including but not limited to any images, photographs, animations, video, audio, music, text, and "applets," incorporated into the SOFTWARE PRODUCT), the accompanying printed materials, and any copies of the SOFTWARE PRODUCT, are owned by BenQ or its suppliers. The SOFTWARE PRODUCT is protected by copyright laws and international treaty provisions. Therefore, you must treat the SOFTWARE PRODUCT like any other copyrighted material. You may not copy SOFTWARE or the printed materials accompanying the SOFTWARE.

<Memo>

# iv Table of Contents

Important safety instructions .....	1
Introduction .....	5
Projector features .....	5
Shipping contents .....	6
Optional accessories .....	6
Projector exterior view .....	7
Front / Upper side .....	7
Rear side .....	7
Lower side .....	7
Controls and functions .....	8
External control panel .....	8
Remote control description .....	10
Remote control effective range .....	11
Installing or replacing the remote control battery .....	11
Positioning your projector .....	12
Choosing a location .....	12
Obtaining a preferred projected image size .....	12
How to determine the position of the projector for a given screen size	13
How to determine the recommended screen size for a given distance	14
Screen size chart.....	15
Connection .....	16
Connecting a computer .....	16
Connecting Video source devices .....	17
Connecting a Component Video source device.....	18
Connecting an S-Video source device.....	19
Connecting a composite Video source device.....	20
Using the projector .....	21
Start up .....	21
Utilizing the password function .....	22
To set a password .....	22
If you forget the password .....	23
To enter the password recall procedure .....	23
To change the password .....	23
Adjusting the height .....	24
Auto-adjusting the image .....	24

Fine-tuning the image size and clarity .....	24
Correcting keystone .....	25
Manual keystone correction .....	25
Automatic keystone correction .....	26
Selecting an application mode .....	26
Switching input signal .....	26
Hiding the image .....	26
Remote paging operations .....	27
Freezing the image .....	27
Shutdown .....	27
Using the wireless functions .....	28
About wireless connection modes and channels .....	28
Hardware and software requirements .....	28
Preparing your computer for wireless connection .....	29
Making wireless presentation .....	30
Controlling presentation .....	34
Disconnecting .....	35
Menu operation .....	36
Menu system .....	36
Using the menus .....	37
1. Picture menu .....	38
2. Pro-Picture menu .....	40
3. Setting menu .....	41
4. Advance menu .....	42
5. Information Menu .....	44
Maintenance .....	45
Care of the projector .....	45
Cleaning the lens .....	45
Cleaning the projector case .....	45
Storing the projector .....	45
Transporting the projector .....	45
Calculation of lamp hour .....	46
Warning message .....	46
Replacing the lamp .....	47
Temperature information .....	48
Indicators .....	49
Troubleshooting .....	51
Specifications .....	53
projector specifications .....	53

Dimensions .....	54
Timing chart .....	54
Supported timing for PC input .....	54
Supported timing for Component-YPbPr Input .....	55
Supported timing for Video and S-Video inputs .....	55
Warranty.....	56
Limited warranty .....	56
Regulation statements.....	57
FCC statement .....	57
EEC statement .....	57
MIC statement .....	57



<Memo>

# 1 Important safety instructions

Your BenQ projector is designed and tested to meet the latest standards for safety of information technology equipment. However, to ensure safe use of this product, it is important that you follow the instructions mentioned in this manual and marked on the product.

## Caution

- **To prevent shock, do not open the cabinet.** There are no user serviceable parts inside.

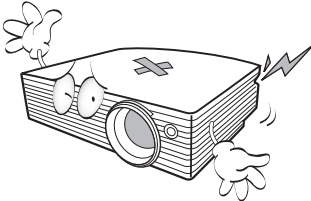

- **Please read this user's manual before you operate your projector.** Save this user's manual for future reference.

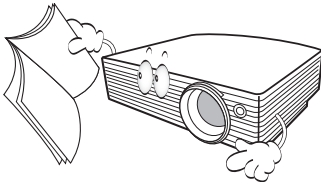

- **Do not look straight at the projector lens during operation.** The intense light beam may damage your eyes.

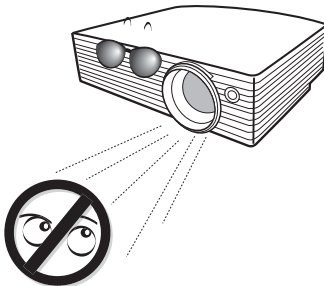

- **Refer servicing to qualified service personnel.**

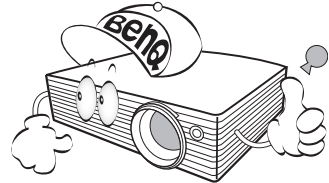

- **Always open the lens shutter or remove the lens cap when the projector lamp is on.**

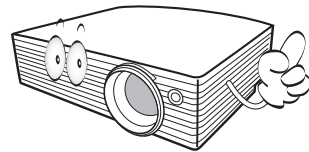

- In some countries, the line voltage is NOT stable. This projector is designed to operate safely within a mains voltage between 100 to 240 volts AC, but could fail if power cuts or surges of  $\pm 10$  volts occur. **In areas where the mains voltage may fluctuate or cut out, it is recommended that you connect your projector through a power stabilizer, surge protector or uninterruptible power supply (UPS).**

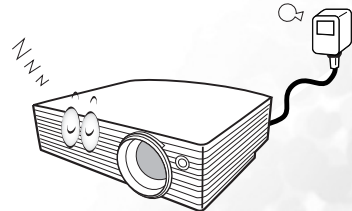

## Safety instructions

1. The lamp becomes extremely hot during operation. Allow the projector to cool for approximately 45 minutes prior to removing the lamp assembly for replacement.

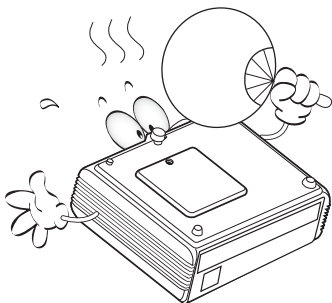

2. Do not operate lamps beyond the rated lamp life. Excessive operation of lamps beyond the rated life could cause them to break on rare occasions.

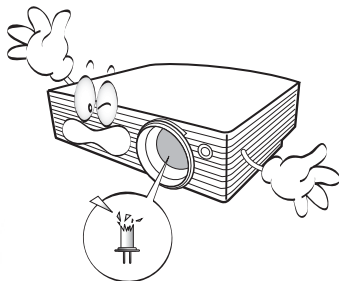

3. Never replace the lamp assembly or any electronic components unless the projector is unplugged.

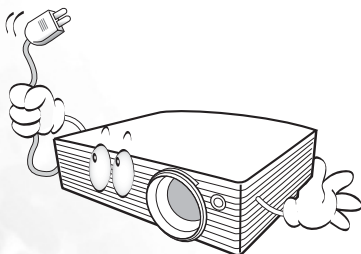

4. Do not place this product on an unstable cart, stand, or table. The product may fall, sustaining serious damage.

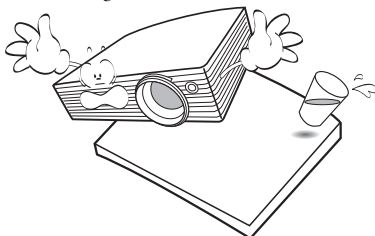

5. To reduce the risk of electric shock, do not disassemble this appliance. Take it to a qualified technician when service or repair is required. Incorrect reassembly can cause malfunction of the projector or electric shock when the appliance is subsequently used.

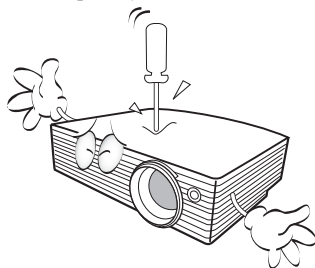

6. Do not stand the unit on end vertically. Doing so may cause the unit to fall over, causing injury or resulting in damage to the unit.

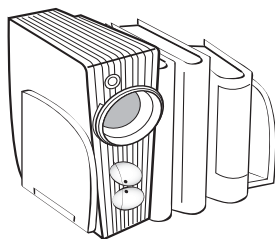

## Safety instructions (continued)

7. Do not place this projector in any of the following environments.

- Space that is poorly ventilated or confined. Allow at least 50 cm clearance from walls and free flow of air around the projector.
- Locations where temperatures may become excessively high, such as the inside of a car with all windows rolled up.
- Locations where excessive humidity, dust, or cigarette smoke may contaminate optical components, shortening the projector's life span and darkening the image.

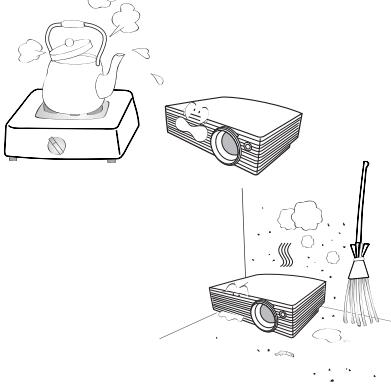

- Locations near fire alarms
- Locations with an ambient temperature above 40°C / 104°F
- Locations where the altitudes are higher than 10000 feet.

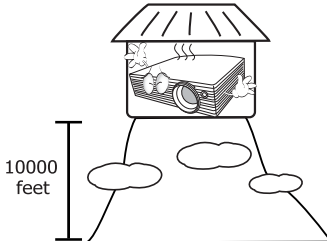

8. Do not block the ventilation holes.

- Do not place this unit on a blanket, bedding or any other soft surface.
- Do not cover this unit with a cloth or any other item.
- Do not place inflammables near the projector.

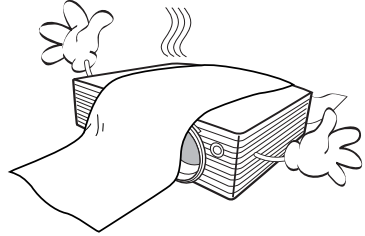

If the ventilation holes are seriously obstructed, overheating inside the unit may result in a fire.

9. Always place the unit on a level, horizontal surface during operation.

- Do not use if tilted at an angle of more than 10 degrees left to right, nor at angle of more than 15 degrees front to back. Using the unit when it is not fully horizontal may cause a malfunction of, or damage to, the lamp.

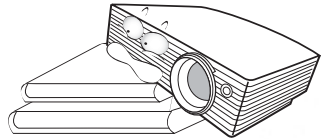

10. Do not step on the projector or place any objects upon it.



- Besides probable physical damage to the projector, doing so may result in accidents and possible injury.

## Safety instructions (continued)

11. Do not block the projection lens with any objects when the projector is under operation as this could cause the objects to become heated or deformed or even cause a fire. To temporarily turn off the lamp, press **BLANK** button on the projector or remote control.

12. Do not place liquids near or on the projector. Liquids spilled into the projector may cause it to fail. If the projector does become wet, disconnect it from the power supply's wall socket and call BenQ to have the projector serviced.

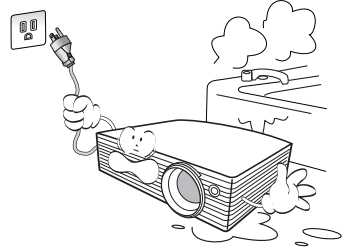

# 2 Introduction

## Projector features

The projector integrates high-performance optical engine projection and a user-friendly design to deliver high reliability and ease of use. It offers the following features:

- **Wireless connectivity**

The projector provides wireless connectivity that allows up to 10 computers to share one projector without the hassle of changing cables.

- **Selectable wireless connection modes**

The wireless connection modes (IEEE 802.11 a/b/g) are selectable, maximizing the projector's wireless compatibility with most of the computers on the market.

 **The 802.11 a mode may not be available on the projectors sold in certain countries/areas due to local regulations.**

- **Compact and lightweight design**

The projector's compact size and light weight design contributes to enhanced portability and mobility.

- **Password protection**

The selectable password-protect function helps to block unauthorized use of the projector.

- **High quality manual zoom lens**

The high quality manual zoom lens design ensures that the projector can deliver suitable projected images in various kinds of environments and spaces.

- **One-key auto-adjustment**

With this function, it takes only one press of a button to let the projector achieve the optimized picture quality from any PC Video source.

- **Digital keystone correction**

The auto and manual digital keystone correction functions make it possible to correct distorted images without having to move the location of the projector.

- **Adjustable color balance control for data/video display**

With this function, you can fine-tune the color balance of projected images appropriate to the video source being used and ambient lighting.

- **Ultra-high brightness projection lamp**

The high brightness makes it possible to deliver the brightest possible projected images.

- **Multi-language on-screen menu**

The projector provides on-screen menu in a choice of several languages.

- **Power saving function**

Switchable normal and Economic modes to reduce the power consumption.

 **The apparent brightness of the projected image will vary depending on the ambient lighting conditions, and selected input source contrast/brightness settings.**

**The lamp brightness will decline over time and may vary within the lamp manufacturers specifications. This is normal and expected behavior.**

# Shipping contents

The projector is shipped with the cables required for connection to a PC and to video equipment. Carefully unpack and verify that you have all of the items shown below. If any of these items are missing, please contact your place of purchase.

 **The supplied accessories will be suitable for your region, and may differ from those illustrated.**

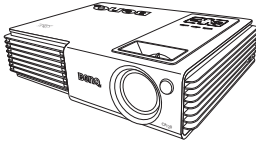

Projector



Soft Carry Case

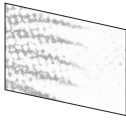

Quick Start Guide



Remote Control with  
Battery

 **Pull the tab before using the remote control.**

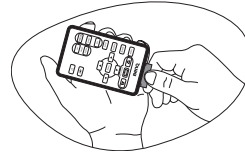

User's Manual



User's Manual/Wire-  
less Wizard CD



USB Cable

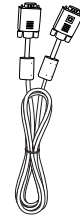

VGA Cable



Power Cord

## Optional accessories

- Macintosh adapter
- 132W lamp module (replacement or spare)
- Component Video to VGA (D-sub) adaptor cable
- Combo (for notebook computer and projector) soft carry case

# Projector exterior view

## Front / Upper side

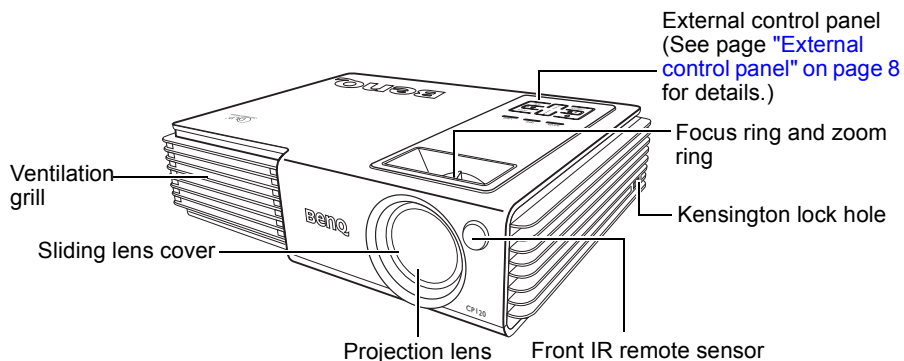

## Rear side

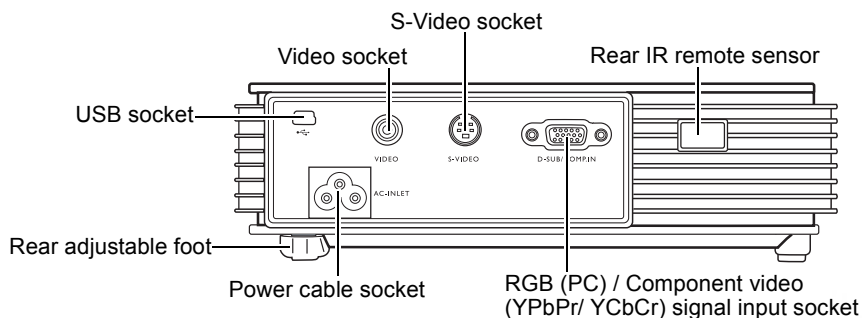

## Lower side

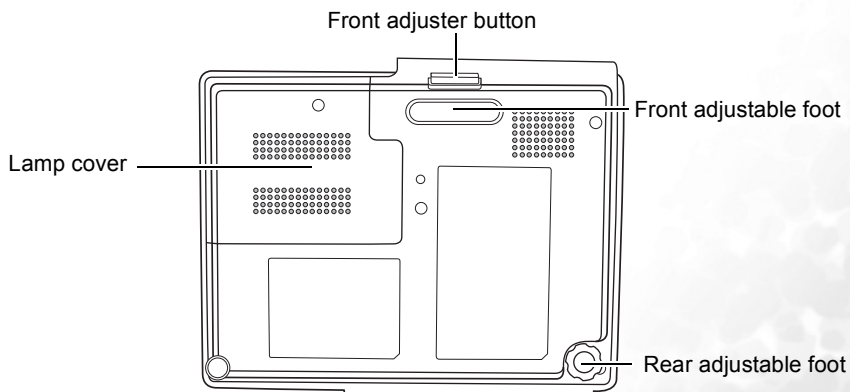



# Controls and functions

## External control panel

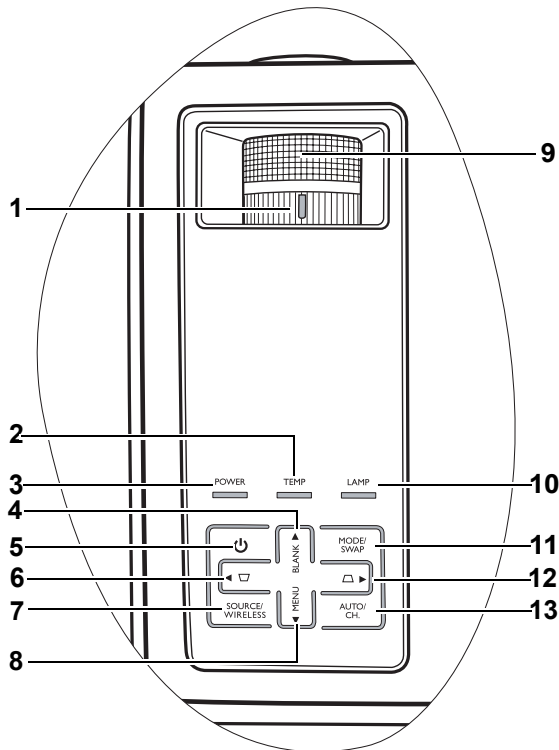

- 1. Zoom ring (Refer to "Fine-tuning the image size and clarity" on page 24 for more information)**  
Adjusts the size of the projected image. Rotate clockwise to enlarge the image or rotate counter-clockwise to reduce the image size.
- 2. TEMPERature warning light (Refer to "Indicators" on page 49 for more information)**  
Flashes red if the projector's temperature becomes too high.
- 3. POWER indicator light (Refer to "Indicators" on page 49 for more information)**  
Lights up or flashes when the projector is under operation.
- 4. BLANK/▲ Up button (Refer to "Hiding the image" on page 26 and "Using the menus" on page 37 for more information)**  
Press this button to hide the screen image. You can press this button again to bring the image back.  
When the on-screen menu is activated, press this button to move the selection focus up.
- 5. POWER button (Refer to "Start up" on page 21 and "Shutdown" on page 27 for more information)**  
Turns the projector on or off.

When the projector is in standby, press once to turn the projector on.

When the projector is on, press twice to switch the projector to standby.

6. **Keystone ▽ / ◀ Left button (Refer to "Correcting keystone" on page 25 and "Using the menus" on page 37 for more information)**

Press this button to correct keystone at the top of the projected image.

When the on-screen menu is activated, press this button to move the selection focus left or make adjustments.
7. **SOURCE/WIRELESS button (Refer to "Switching input signal" on page 26 and "Using the wireless functions" on page 28 for more information)**

Switches sequentially through input sources. (RGB/YPbPr, Video, S-Video or Wireless).

During a wireless presentation, press this button to display the Wireless Connection menu.
8. **MENU / ▼ Down button (Refer to "Using the menus" on page 37 for more information)**

Turns on the On-Screen Display (OSD) menu.

When the on-screen menu is activated, press this button to move the selection focus down.
9. **Focus ring (Refer to "Fine-tuning the image size and clarity" on page 24 for more information)**

Adjusts the focus of the projected image.
10. **LAMP indicator light (Refer to "Indicators" on page 49 for more information)**

Lights up or flashes when the projector lamp has developed a problem.
11. **MODE/SWAP button (Refer to "Selecting an application mode" on page 26 and "Making wireless presentation" on page 30 for more information)**

Selects one of the application modes.

When the Wireless Connection menu is displayed, press this button to change the wireless connection mode between 802.11 a and 802.11 b/g.
12. **Keystone ▴ / ▶ Right button (Refer to "Correcting keystone" on page 25 and "Using the menus" on page 37 for more information)**

Press this button to correct keystone at the bottom of the projected image.

When the on-screen menu is activated, press this button to move the selection focus right or make adjustments.
13. **AUTO/CH. button (Refer to "Auto-adjusting the image" on page 24 and "Making wireless presentation" on page 30 for more information)**

Press this button to let the projector automatically determine the best picture timings for the projected image.

When the Wireless Connection menu is displayed, press this button to change the wireless connection channel.

# Remote control description

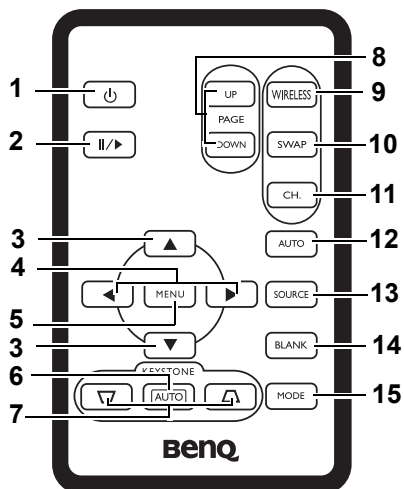



- 1. Power** (Refer to **"Start up"** on page 21 and **"Shutdown"** on page 27 for more information)  
Turns the projector on or off.  
When the projector is in standby, press once to turn the projector on.  
When the projector is on, press twice to switch the projector to standby.
- 2. Freeze**  
The image is frozen when **Freeze** is pressed. An icon "▄▄" will display in the lower right corner of the screen.  
To release the function, press **Freeze** again or the **Source** button.
- 3. ▲ Up, ▼ Down**
- 4. ◀ Left, ▶ Right**  
When the on-screen menu is activated, the Up/Down/Left/Right buttons are used as directional arrows to select the desired menu items and to make adjustments.
- 5. Menu** (Refer to **"Using the menus"** on page 37 for more information.)  
Turns on the On-Screen Display (OSD) menu.
- 6. Auto keystone**  
Automatically corrects distorted images resulting from an angled projection.
- 7. ▱ Keystone ▽** (Refer to **"Correcting keystone"** on page 25 for more information.)  
Manually corrects distorted images resulting from an angled projection.
- 8. Page Up and Down**  
You can operate your display software program (on a connected PC) which responds to page up/down commands (like Microsoft PowerPoint) by pressing Page Up and Page Down on the remote control.
- 9. Wireless**  
Press this button to display the Wireless Connection menu.
- 10. Swap** (Refer to **"Making wireless presentation"** on page 30 for more information.)  
When the Wireless Connection menu is displayed, press this button to change the wireless connection mode between 802.11 a and 802.11 b/g.

11. **Channel** (Refer to "**Making wireless presentation**" on page 30 for more information.)  
When the Wireless Connection menu is displayed, press this button to change the wireless connection channel.
12. **Auto** (Refer to "**Auto-adjusting the image**" on page 24 for more information.)  
Automatically determines the best picture settings for the displayed image.
13. **Source** (Refer to "**Switching input signal**" on page 26 for more information.)  
Sequentially selects input sources. (RGB/YPbPr-> Video-> S-Video-> Wireless)
14. **Blank** (Refer to "**Switching input signal**" on page 26 for more information.)  
Used to hide the screen image. Press **Blank** again to restore the image.
15. **Mode** (Refer to "**Application Mode**" on page 38 for more information.)  
Depending upon which input signal is selected, there are several picture setup options available.

## Remote control effective range

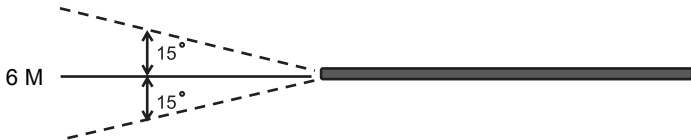
Infra-Red (IR) remote control sensors are located on the front and the back of the projector. The remote control must be held at an angle within 30 degrees of the projector's IR remote control sensors to function correctly. The distance between the remote control and the sensors should not exceed 6 meters (~ 20 feet).



 **Make sure that there are no obstacles between the remote control and the IR sensors on the projector that might obstruct the infra-red beam.**

## Installing or replacing the remote control battery

1. Pull out the battery holder.
2. Insert the new battery in the holder.  
Note that the positive polarity should face outward.
3. Push the holder into the remote control.

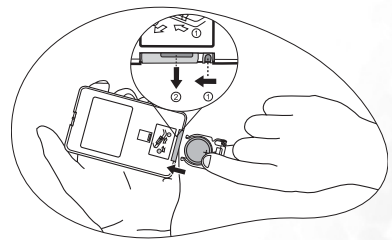

-  **Avoid excessive heat and humidity.**
- There may be danger of damage to the remote and injury to those nearby if the battery is incorrectly replaced.**
- Replace only with the same or equivalent type recommended by the manufacturer.**
- Dispose of the used battery according to the manufacturer's instructions.**
- Never throw a battery into a fire. There may be danger of an explosion.**
- If the battery is dead or if you will not be using the remote control for a long time, remove the battery to prevent damage to the remote control from possible battery leakage.**



# 3 Positioning your projector

## Choosing a location

Your projector is designed to be installed in one of two possible installation locations:

1. Floor in front of screen; or
2. Floor at rear of screen

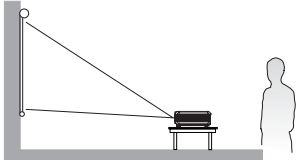
Your room layout or personal preference will dictate which installation location you select. Take into consideration the size and position of your screen, the location of a suitable power outlet, as well as the location and distance between the projector and the rest of your equipment.

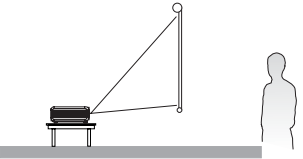
<p><b>I. Floor front:</b> Select this location with the projector placed near the floor in front of the screen. This is the most common way to position the projector for quick setup and portability.</p>	
<p><b>II. Floor rear:</b> Select this location with the projector placed near the floor behind the screen.</p> <p>Note that a special rear projection screen is required. Set  in the <b>Advance</b> &gt; <b>Mirror</b> menu after you turn the projector on.</p>	

## Obtaining a preferred projected image size

The distance from the projector lens to the screen, the zoom setting, and the video format each factors in the projected image size.

The maximum (native) resolution of the projector is 1024 x 768 pixels, which is a 4 to 3 aspect ratio (expressed as 4:3). To be able to project a complete 16:9 (widescreen) aspect ratio image, the projector can resize and scale a widescreen image to the projector's native aspect width. This will result in a proportionally smaller height equivalent to 75% of the projector's native aspect height.

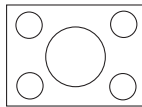

4:3 aspect image in a 4:3 aspect display area

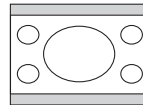

16:9 aspect image scaled to a 4:3 aspect display area

Thus, a 16:9 aspect image will not utilize 25% of the height of a 4:3 aspect image displayed by this projector. This will be seen as darkened (unlit) bars along the top and bottom (vertical 12.5% height respectively) of the 4:3 projection display area whenever displaying a scaled 16:9 aspect image in the vertical centre of the 4:3 projection display area.

When determining the position of your projector, you should consider its intended use and input signal aspect ratios. All inputs (other than composite Video being fed a 16:9 aspect

signal) will display in a 4:3 aspect ratio (and will require an additional 33% display height than that of the scaled 16:9 aspect image projection area).

 **IMPORTANT: Do not select a permanent projector position based upon a 16:9 projection if you will ever need to select an input other than composite Video being fed a 16:9 aspect signal.**

The projector should always be placed horizontally level (like flat on a table), and positioned directly perpendicular (90° right-angle square) to the horizontal centre of the screen. This prevents image distortion caused by angled projections (or projecting onto angled surfaces).

The modern digital projector does not project directly forward (like older style reel-to-reel film projectors did). Instead, digital projectors are designed to project at a slightly upward angle above the horizontal plane of the projector. This is so that they can be readily placed on a table and will project forward and upwards onto a screen positioned so that the bottom edge of the screen is above the level of the table (and everyone in the room can see the screen).

You can see from the diagram on page 15, that this type of projection causes the bottom edge of the projected image to be vertically offset from the horizontal plane of the projector. If the projector is positioned further away from the screen, the projected image size increases, and the vertical offset also increases proportionately.

When determining the position of the screen and projector, you will need to account for both the projected image size and the vertical offset dimension, which are directly proportional to the projection distance.

BenQ has provided a table of 4:3-aspect-ratio screen sizes (see "[Screen size chart](#)" on page 15) to assist you in determining the ideal location for your projector. There are two dimensions to consider, the perpendicular horizontal distance from the centre of the screen (projection distance), and the vertical offset height of the projector from the horizontal edge of the screen (offset).

## How to determine the position of the projector for a given screen size

1. Select your screen size.
2. Refer to the table on page 15 and find the closest match to your screen size in the left columns labelled '4:3 Screen Diagonal' and '4:3 Aspect in mm'. Using this value, look across this row to the right to find the corresponding average distance from screen value in the column labelled 'Average'. This is the projection distance.
3. On that same row, look across to the right column and make note of the vertical Offset value. This will determine the final vertical offset placement of the projector in relation to the edge of the screen.
4. The recommended position for the projector is aligned perpendicular to the horizontal centre of the screen, at the distance from the screen determined in step 2 above, and offset by the value determined in step 3 above.

For example, if you are using a 120-inch screen, the average projection distance is 4757 mm and with a vertical offset of 229 mm.

If you place the projector in a different position (to that recommended), you will have to tilt it down or up to center the image on the screen. In these situations, some image distortion will occur. Use the Keystone function to correct the distortion. See "[Correcting keystone](#)" on page 25 for keystone correction.

## How to determine the recommended screen size for a given distance

This method can be used for situations where you have purchased this projector and would like to know what screen size will fit in your room. The maximum screen size is limited by the physical space available in your room.

1. Measure the distance between the projector and where you want to position the screen. This is the projection distance.
2. Refer to the table on page 15 and find the closest match to your measurement in the average distance from screen column labelled 'Average'. Check that your measured distance is between the min and max distances listed on either side of the average distance value.
3. Using this value, look across that row to the left to find the corresponding screen diameter listed in that row. That is the projected image size of the projector at that projection distance.
4. On that same row, look across to the right column and make note of the vertical Offset value. This will determine the final placement of the screen in relation to the horizontal plane of the projector.

For example, if your measured projection distance was 4.5m (4500mm), the closest match in the Average column is 4682mm. Looking across this row shows that a 3000mm (3m) screen is required. If you can only obtain imperial sized screens, the listed screen sizes on either side of the 3m screen are the 9' and 10' screens.

Checking the min and max projection distance values for the these (9' & 10') sizes, indicates that the 4.5m measured projection distance will fit these screens too. The projector can be adjusted (using the zoom control) to display on these different screen sizes at that projection distance. Be aware that these different screens have different vertical offset values.

# Screen size chart

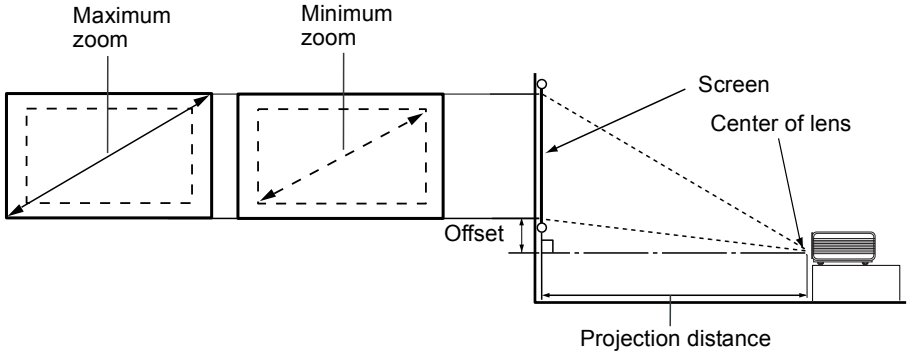

4:3 Screen Diagonal			4:3 Aspect in mm		Distance from Screen in mm			Vertical Offset in mm
Feet	Inches	mm	Width	Height	Min length (with max. zoom)	Average	Max length (with min. zoom)	
4	48	1219	975	732	1752	1903	2054	91
		1500	1200	900	2155	2341	2527	113
5	60	1524	1219	914	2190	2379	2568	114
		1829	1463	1097	2628	2854	3081	137
6	72	2000	1600	1200	2874	3122	3370	150
		2134	1707	1280	3066	3330	3595	160
7	84	2438	1951	1463	3503	3806	4109	183
		2500	2000	1500	3592	3902	4212	188
8	96	2743	2195	1646	3941	4282	4622	206
		3000	2400	1800	4310	4682	5054	225
9	108	3048	2438	1829	4379	4757	5135	229
		3500	2800	2100	5029	5463	5897	263
10	120	3658	2926	2195	5256	5709	6163	274
		4000	3200	2400	5747	6243	6739	300
12	144	4572	3658	2743	6569	7136	7703	343
		5000	4000	3000	7184	7804	8424	375
15	180	5486	4389	3292	7883	8563	9244	411
		6000	4800	3600	8621	9365	10109	450
25	300	7620	6096	4572	10948	11893	12838	572

 There is 3% ~ 5% tolerance among these numbers due to optical component variations.



## 4 Connection

When connecting a signal source to the projector, be sure to:

1. Turn all equipment off before making any connections.
2. Use the correct signal cables for each source.
3. Ensure the cables are firmly inserted.

 **In the connections shown below, some cables may not be included with the projector (see "Shipping contents" on page 6). They are commercially available from electronics stores.**

**This projector has no speaker or built-in support for audio reproduction.**

### Connecting a computer

The projector provides a VGA input socket that allows you to connect it to a notebook or desktop computer.

Additionally, you can also connect the projector to a computer via the USB cable so you can perform paging operations of the application on the PC or notebook. (see "Remote paging operations" on page 27).

The projector can also be connected to a computer via wireless connection. See "Using the wireless functions" on page 28 for details.

To connect the projector to a notebook or desktop computer:

1. Take the supplied VGA cable and connect one end to the D-Sub output socket of the computer.
2. Connect the other end of the VGA cable to the D-SUB/COMP IN signal input socket on the projector.
3. If you wish to use the remote paging function (see "Remote paging operations" on page 27), take the supplied USB cable and connect the larger end to the USB port of the computer, and the smaller end to the USB socket on the projector.

The final connection path should be like that shown in the following diagram:

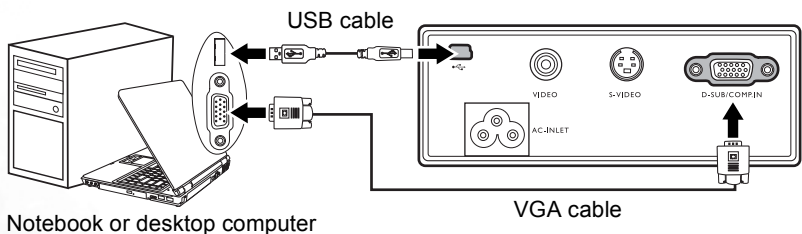

 **A Mac adapter (an optional accessory) is needed if you are connecting legacy version ([www.apple.com/usen/legacy/legacy\\_list.html](http://www.apple.com/usen/legacy/legacy_list.html)) Macintosh computers.**

**Many notebook computers do not turn on their external video ports when connected to a projector. Usually a key combo like FN + F3 or CRT/LCD key turns the external display on/off. Locate a function key labeled CRT/LCD or a function key with a monitor symbol on the notebook computer. Press FN and the labeled function key simultaneously. Refer to your notebook computer's documentation to find your notebook computer's key combination.**

**For information about how to connect the projector to a computer wirelessly, refer to "Using the wireless functions" on page 28.**

# Connecting Video source devices

This section describes how to connect the projector to Video source devices using video cables. Video cable connections are recommended for Video presentations.

 **This projector also supports data (graphic) "PC" connection using wireless local area network (WLAN) connection. WLAN connection is not recommended for Video presentations. See "Using the wireless functions" on page 28.**

You can connect your projector to various Video source devices that provide any one of the following output sockets:

- Component Video
- S-Video
- Video (composite)

You need only connect the projector to a Video source device using just one of the above connecting methods, however each provides a different level of video quality. The method you choose will most likely depend upon the availability of matching terminals on both the projector and the Video source device as described below:

## Best video quality

The best available video connection method is Component Video (not to be confused with composite Video). Digital TV tuner and DVD players output Component Video natively, so if available on your devices, this should be your connection method of choice in preference to (composite) Video.

See ["Connecting a Component Video source device" on page 18](#) for how to connect the projector to a component video device.

## Better video quality

The S-Video method provides a better quality analog video than standard composite Video. If you have both composite Video and S-Video output terminals on your Video source device, you should elect to use the S-Video option.

See ["Connecting an S-Video source device" on page 19](#) for how to connect the projector to an S-Video device.

## Least video quality

Composite Video is an analog video and will result in a perfectly acceptable, but less than optimal result from your projector, being the least video quality of the available methods described here.

See ["Connecting a composite Video source device" on page 20](#) for how to connect the projector to a composite Video device.

## Connecting a Component Video source device

Examine your Video source device to determine if it has a set of unused Component Video output sockets available:

- If so, you can continue with this procedure.
- If not, you will need to reassess which method you can use to connect to the device.

### To connect the projector to a Component Video source device

1. Take the (optional accessory) Component Video to VGA (D-Sub) adaptor cable and connect the end with 3 RCA type connectors to the Component Video output sockets of the Video source device. Match the color of the plugs to the color of the sockets; green to green, blue to blue, and red to red.
2. Connect the other end of the Component Video to VGA (D-Sub) adaptor cable (with a D-Sub type connector) to the D-SUB/COMP IN socket on the projector.

The final connection path should be like that shown in the following diagram:

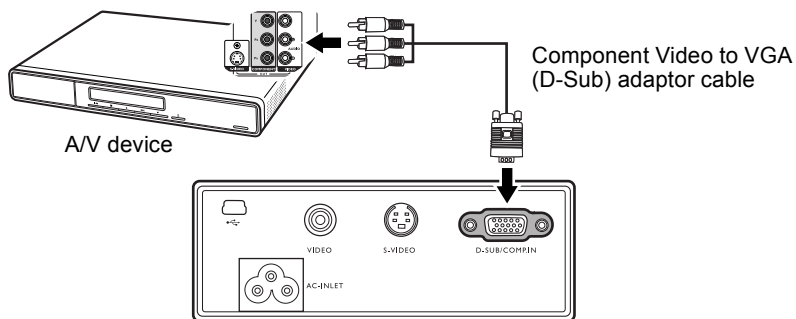

**Component Video is the only video output that delivers native 16:9 aspect ratio picture.**

If you connect the projector to a High Definition TV (HDTV) tuner, the following standards are supported:

- 480i
- 576i
- 720p (50/ 60 Hz)
- 480p
- 576p
- 1080i (50/ 60 Hz)

**If the selected video image is not displayed after the projector is turned on and the correct video source has been selected, check that the Video source device is turned on and operating correctly. Also check that the signal cables have been connected correctly.**

## Connecting an S-Video source device

Examine your Video source device to determine if it has an unused S-Video output socket available:

- If so, you can continue with this procedure.
- If not, you will need to reassess which method you can use to connect to the device.

### To connect the projector to an S-Video source device

1. Take an appropriate S-Video cable (not supplied) and connect one end to the S-Video output socket of the Video source device.
2. Connect the other end of the S-Video cable to the S-VIDEO socket on the projector.

The final connection path should be like that shown in the following diagram:

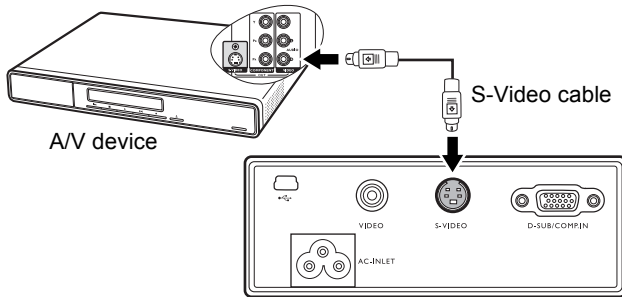

- ☞ • If the selected video image is not displayed after the projector is turned on and the correct video source has been selected, check that the Video source device is turned on and operating correctly. Also check that the signal cables have been connected correctly.
- If you have already made a Component Video connection between the projector and this S-Video source device using Component Video connections, you need not connect to this device using an S-Video connection as this makes an unnecessary second connection of poorer picture quality. See ["Connecting Video source devices" on page 17](#) for details.

## Connecting a composite Video source device

Examine your Video source device to determine if it has a set of unused composite Video output sockets available:

- If so, you can continue with this procedure.
- If not, you will need to reassess which method you can use to connect to the device.

### To connect the projector to an composite Video source device

1. Take an appropriate Video cable (not supplied) and connect one end to the composite Video output socket of the Video source device.
2. Connect the other end of the Video cable to the VIDEO socket on the projector.

The final connection path should be like that shown in the following diagram:

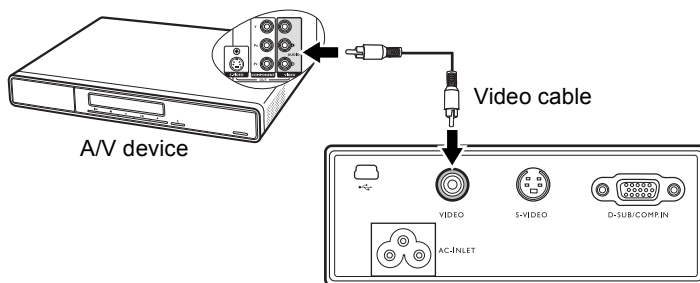

 • If the selected video image is not displayed after the projector is turned on and the correct video source has been selected, check that the Video source device is turned on and operating correctly. Also check that the signal cables have been connected correctly.

- You need only connect to this device using a composite Video connection if Component Video and S-Video inputs are unavailable for use. See ["Connecting Video source devices" on page 17](#) for details.

# 5 Using the projector

## Start up

1. Plug the power cord into the projector and into a wall socket. Turn on the wall socket switch (where fitted). Check that the **POWER** indicator on the projector lights orange after power has been applied.

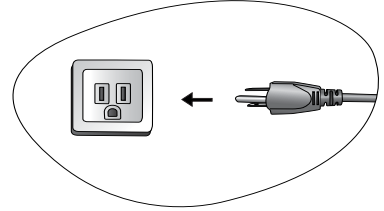
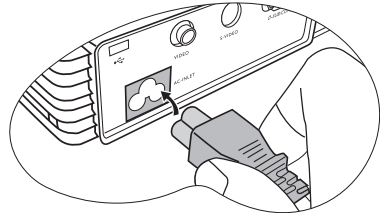

2. Slide open the lens cover. If it is left closed, it could become deformed due to heat.

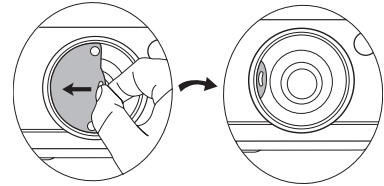

3. Press and hold (for 2 seconds) the **POWER** button on the remote control or projector to start the unit. The **POWER** indicator light flashes green and stays green when the unit is on.

The start up procedure takes about 30 seconds after pressing the **POWER** button. In the later stage of start up, a default BenQ logo is projected.

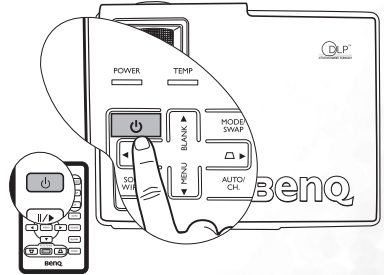

 **If the projector is still hot from previous activity, it will run the cooling fan for approximately 90 seconds before energising the lamp.**

4. If you are prompted for a password, press the arrow buttons to select the four password digits, then press the **Auto** (or **AUTO/CH.**) button. For information about the password function, refer to ["Utilizing the password function" on page 22](#).
5. Switch all of the connected equipment on.
6. The current input source being scanned displays in the upper part of a dialog on the screen. The scan will continue until signal from the input source is detected.

 **If the Auto Off function (See ["Auto Off \(Off\)" on page 43](#) for details) is activated, the projector will turn off automatically if no input signal is detected from the selected source after the period of time as set by the Auto Off function.**

The projector will also display its name, current wireless connection mode and channel in the lower part of the dialog. The default wireless connection mode is 802.11 b/g. The projector name is used to identify which projector to connect when you have multiple projectors available in the same location.

If a wireless connection is detected, the Wireless Connection menu will display automatically.

- ☞ **For more information about wireless connection modes, channels and how to establish wireless connection between the projector and computer, please refer to "Using the wireless functions" on page 28.**
- **The 802.11 a mode may not be available on the projectors sold in certain countries/areas due to local regulations.**

You can also press the **Source** (or **SOURCE/WIRELESS**) button to select your desired input signal manually. For more information, please refer to "Switching input signal" on page 26.

- ☞ **If the frequency/ resolution of the input signal exceeds the projector's operating range, you will see the message "Out of Range" displayed on a blank screen. This message will remain on-screen until you change the input signal to an appropriate source.**

## Utilizing the password function

For security purposes and to help prevent unauthorized use, the projector includes an option for setting up password security. The password can be set through the on-screen menu. For details of the on-screen menu operation, please refer to "Using the menus" on page 37 for information.

- ☞ **WARNING: You will be inconvenienced if you activate the password functionality and subsequently forget the password. Print out this manual and write the password you used in this manual, and keep the manual in a safe place for later recall.**

### To set a password

- ☞ **CAUTION: Once a password has been set, the projector cannot be used unless the correct password is entered every time the projector is started.**

1. Open the on-screen menu and go to  **Setting > Password**. Select **On** by pressing the ◀ or ▶ buttons.
2. When the function is activated for the first time, a prompt will display on the screen. Use the ▲ or ▼ button to select a number for each digit of the password. Use the ◀ or ▶ button to move between the digits of the password.
3. When all digits are entered and the password is ready, press the **Auto** (or **AUTO/CH.**) button to confirm. A confirmation message displays.

- ☞ **The password will display on-screen when being input.**
- **IMPORTANT: Write your selected password down here in this manual so that it is available to you should you ever forget it.**

**Password:** \_ \_ \_ \_

**Keep this manual in a safe place.**

4. You have the following options:
  - Press **Auto** to continue. The set-up is finished when the message “Password setup completed” displays.
  - Press the ▲ button to go back to the previous screen and re-enter four digits.
  - Press the ▼ button to cancel the password set-up and return to the on-screen menu.

## If you forget the password

Once activated, you will be asked to enter the four-digit password every time you turn on the projector. If you enter the wrong password, the password error message displays. You can retry by turning off the projector (by pressing the **POWER** button) and start again, or if you did not record the password in this manual, and you absolutely do not remember it, you can use the password recall procedure.

## To enter the password recall procedure

Press and hold the ▶ button for 5 seconds. The projector will display a coded number on the screen. Seek help from the local BenQ service center to decode the number. You may be required to provide proof of purchase documentation to verify that you are an authorized user of the projector.

## To change the password

1. Open the on-screen menu and go to  **Setting > Change Password**.
2. Press the ◀ or ▶ button. A “Change Password” message displays.
3. Enter the old password.
  - If the password is correct, you can go on to enter new password.

 **IMPORTANT: Write your selected password down here in this manual so that it is available to you should you ever forget it.**

**Password:** \_ \_ \_ \_

**Keep this manual in a safe place.**

- If the password is incorrect, a “Password Error” message displays. Press the ▲ button to try again or press the ▼ button to cancel.
4. Check the new password.
  5. You have the following options:
    - Press the **Auto** (or **AUTO/CH.**) button to complete the procedure.
    - Press the ▲ button to try again.
    - Press the ▼ button to cancel the set-up and return to the on-screen menu.



# Adjusting the height

The projector is equipped with one quick-release adjuster foot and one rear adjuster foot. These adjusters change the image height and projection angle. To adjust the projector:

1. Lift the projector up and press the adjuster button to release the adjuster. The adjuster will drop into position and be locked.

 **Do not look into the lens while the lamp is on. The strong light from the lamp may cause damage to your eyes.**

2. Screw the rear adjuster foot to fine tune the horizontal angle.

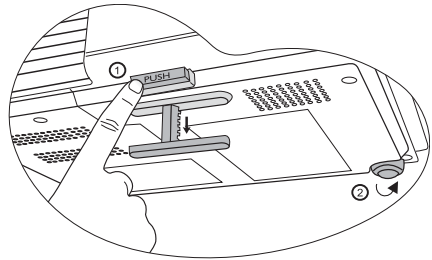

To retract the foot, hold up the projector while pressing the front adjuster button, then slowly lower the projector. Screw the rear adjuster foot in a reverse direction.

 **If the screen and the projector are not perpendicular to each other, the projected image becomes vertically trapezoidal. To correct this situation, adjust the value of Keystone in the Picture menu, on the projector control panel, or on the remote control.**

# Auto-adjusting the image

In some cases, you may need to optimize the picture quality.

To do this, press **Auto** (or **AUTO/CH.**). Within 3 seconds, the built-in Intelligent Auto Adjustment function will re-adjust the values of Frequency and Clock to provide the best picture quality.

The current source information will be displayed at the bottom right of the screen for 3 seconds.

 **The screen will be blank while Auto is functioning.**

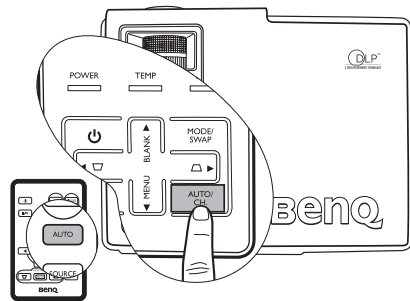

# Fine-tuning the image size and clarity

1. Adjust the projected image to the size that you need using the zoom ring.
2. Then sharpen the image by rotating the focus ring.

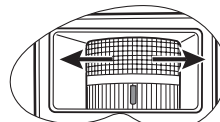
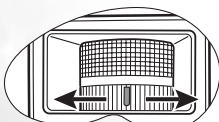

Refer to the screen size tables in "[Obtaining a preferred projected image size](#)" on page 12.

# Correcting keystone

Keystoning refers to the situation where the projected image is noticeably wider at either the top or bottom. It occurs when the projector is not perpendicular to the screen.

## Manual keystone correction

To correct keystoning manually, you can perform the following steps.

1. Adjust the projection angle of the projector.
2. Press the **Auto** (or **AUTO/CH.**) button.
3. If the image is still distorted, you will need to manually correct it following ONE of these steps.
  - Press the **Keystone** ▾ / ◀ **Left** or **Keystone** ▴ / ▶ **Right** buttons on the control panel of the projector to display the status bar labelled Keystone. Press the **Keystone** ▾ / ◀ **Left** button to correct keystoning at the top of the image. Press the **Keystone** ▴ / ▶ **Right** button to correct keystoning at the bottom of the image.
  - Press the ▾ / ▴ buttons on the remote control to display the status bar labelled Keystone, then press the ▾ button to correct keystoning at the top of the image or press the ▴ button to correct keystoning at the bottom of the image.
  - Press the **MENU** / ▼ **Down** button on the projector or the **MENU** button on the remote control. Go to  **Picture** --> **Keystone** and adjust the values by pressing the **Keystone** ▾ / ◀ **Left** or **Keystone** ▴ / ▶ **Right** buttons on the projector, or the ◀ **Left** or ▶ **Right** buttons on the remote control.

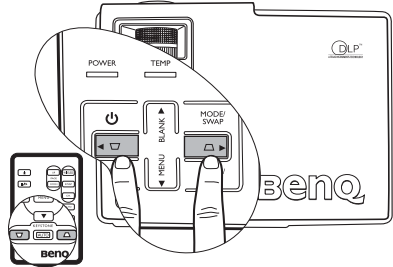

For example,

	<ol style="list-style-type: none"> <li>1. Press the <b>Keystone</b> ▾ / ◀ <b>Left</b> button on the projector or</li> <li>2. Press the ▾ button on the remote control or</li> <li>3. Press the <b>Keystone</b> ▾ / ◀ <b>Left</b> button on the projector, or the ◀ <b>Left</b> button on the remote control when you are in the <b>Picture</b> --&gt; <b>Keystone</b> menu.</li> </ol>	
<p>Keystone  0</p>	<p>Keystone  -6</p>	
	<ol style="list-style-type: none"> <li>1. Press the <b>Keystone</b> ▴ / ▶ <b>Right</b> button on the projector or</li> <li>2. Press the ▴ button on the remote control or</li> <li>3. Press the <b>Keystone</b> ▴ / ▶ <b>Right</b> button on the projector, or the ▶ <b>Right</b> button on the remote control when you are in the <b>Picture</b> --&gt; <b>Keystone</b> menu.</li> </ol>	
<p>Keystone  0</p>	<p>Keystone  +6</p>	

## Automatic keystone correction

Your projector is equipped with Autokeystone function that corrects keystoneing automatically. See "[Autokeystone \(On\)](#)" on page 38 for details.

## Selecting an application mode

The projector is preset with several predefined application modes so that you can choose one to suit your operating environment and input source picture type. To select a operation mode that suits your need, press the **Mode** (or **MODE/SWAP**) button. The application modes available for different types of signals are shown below. See "[Application Mode](#)" on page 38 for details.

PC / Wireless Signal Input				
Brightest	Presentation (default)	sRGB/Photo	Gaming	Video
YPbPr / S-Video / Video Signal Input				
Movie (default)		Cinema	Photo	Gaming

## Switching input signal

The projector can be connected to multiple devices at the same time. However, it can only display one at a time. To cycle through the available input sources, press the **Source** (or **SOURCE/WIRELESS**) button. A source selection menu will display at the center of the screen after you press the button.

 The brightness level of the projected image will change accordingly when you switch between different input signals. Data (graphic) "PC" presentations using mostly static images are generally brighter than "Video" using mostly moving images (movies).

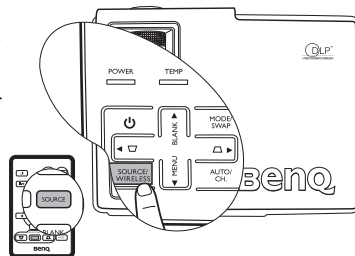



The input type affects the options available for the Application Mode. See "[Selecting an application mode](#)" on page 26 for details.

## Hiding the image

In order to draw the audience's full attention to the presenter, you can press the **Blank** (or **BLANK / ^ Up**) button to hide the screen image. Press the button again to restore the image. The word "**BLANK**" appears at the bottom right corner of the screen while the image is hidden.

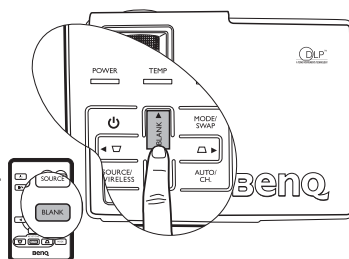
You can set the blank time in the  **Advance -- > Blank Time** menu to let the projector return the image automatically after a period of time when there is no action taken on the blank screen.



 Do not block the projection lens from projecting as this could cause the blocking object to become heated and deformed or even cause a fire.

# Remote paging operations

You can operate your display software program (on a connected PC) which responds to page up/down commands (like Microsoft PowerPoint) by pressing Page Up and Page Down on the remote control. See "Connecting a computer" on page 16 for details.

 **Connect the projector to your PC or notebook with a USB cable prior to using this function.**

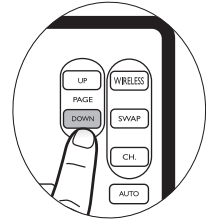

# Freezing the image

Press the **Freeze** button on the remote control to freeze the image. An icon  will display in the lower right corner of the screen. To release the function, press the **Freeze** button on the remote control, or the **Source** (or **SOURCE/WIRELESS**) button.

This does not remotely control the signal source. It just freezes the currently projected image.

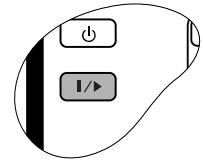

# Shutdown

1. Press the **POWER** button and a prompt message appears. Press the **POWER** button a second time to turn the projector off.
2. The **POWER** indicator light flashes orange and the lamp shuts down, the fans continue to run for the time duration as determined by the Quick Cooling function (see "Quick Cooling (On)" on page 41) to cool down the projector.

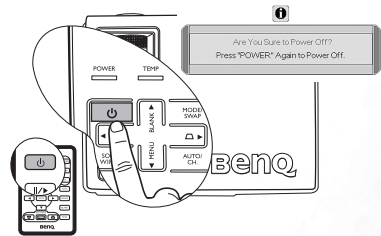

 **To protect the lamp, the projector will not respond to any commands during the cooling process.**

3. Disconnect the power cord from the wall socket.

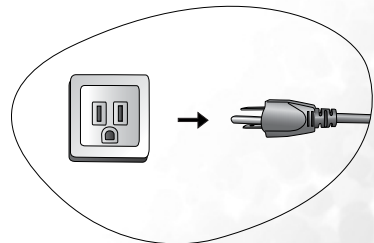

-  **Do not unplug the power cord before the projector shutdown sequence is complete or during the cooling down process.**
- If the projector is not properly shut-down, you risk damaging the lamp. Do not move the projector whilst the lamp is hot.**

# Using the wireless functions

Your projector provides wireless connectivity that allows one or multiple wireless enabled client PCs to connect to the projector. The initial wireless connection process takes two steps:

- Prepare your computer for wireless connection. This includes installing Wireless Wizard and if necessary, configuring the wireless connection settings of your computer manually.
- Use Wireless Wizard to connect the computer to the projector.

 **When presenting via wireless connection, static screen images are captured on the computer and sent to the projector for display. This necessarily involves some processing power on the computer. Therefore, this format is unsuitable for movies and large animated graphics. They will appear jerky.**

Refer to “[Preparing your computer for wireless connection](#)” below for more information.

## About wireless connection modes and channels

Your projector is compatible with the three most popular wireless local area network (Wireless LAN or WLAN) standards defined by IEEE (Institute of Electrical and Electronics Engineers): 802.11 a, 802.11 b and 802.11 g. These standards are referred to in this manual as wireless connection modes.

The 802.11 b mode has a maximum raw data transfer rate of 11 Mbit per second (Mbps), while the 802.11 g mode has a faster speed of 54 Mbps, and is backward compatible with the 802.11 b mode. The 802.11 a mode also allows 54 Mbps data transmission, but operates at a different band and is not backward compatible with the 802.11 b and 802.11 g modes. You need to use the **MODE/SWAP** button on the projector, or the **SWAP** button on the remote control to select a mode that matches that supported by the computer you want to connect.

In order to prevent interference when multiple wireless connections are used in close proximity, each wireless connection mode allows operation in different channels. For example, two 802.11 b networks can work simultaneously without interference under different channels. You can use the **AUTO/CH.** button on the projector, or the **CH.** button on the remote control to select a channel. Note that the channels that are available for use in a particular country differ according to the regulations of that country.

## Hardware and software requirements

In order to display presentations using the wireless functions, check to make sure that your hardware and software satisfies the following requirements:

- Wireless LAN (WLAN or Wi-Fi) enabled computer (PC or Notebook)
- Operating system: Windows 2000 or XP (Home and Pro editions)
- CD drive (for installing Wireless Wizard)

# Preparing your computer for wireless connection

## Checking the TCP/IP settings of your computer

In order for the projector to connect to your computer successfully, your computer must allow automatic IP and DNS address assignment in TCP/IP settings. Follow the steps below to check if the TCP/IP settings of your computer are correctly set.

1. Right-click the Wireless connection  icon on Windows Taskbar, and then select **View Available Wireless Networks** in the menu that appears.

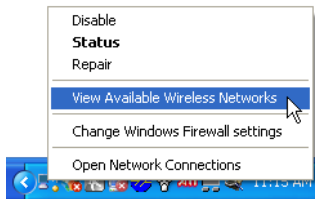

2. The Wireless Network Connection window will pop up. Click **Change advanced settings** to continue.

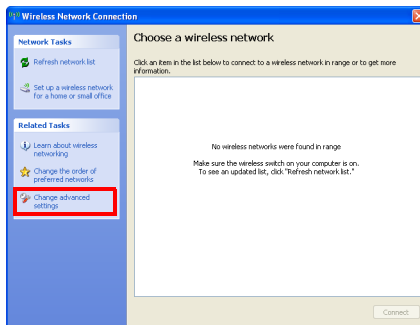

3. In the window that follows, click **Internet Protocol (TCP/IP)** and then the **Properties** button.

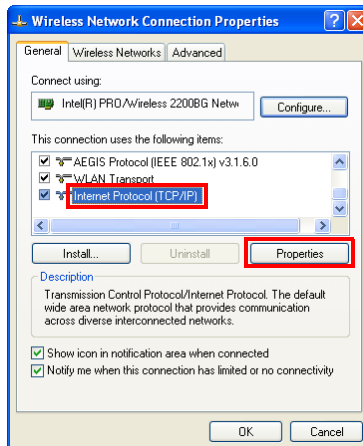

4. Make sure that **Obtain an IP address automatically** and **Obtain DNS server address automatically** are selected, and then click the OK button.

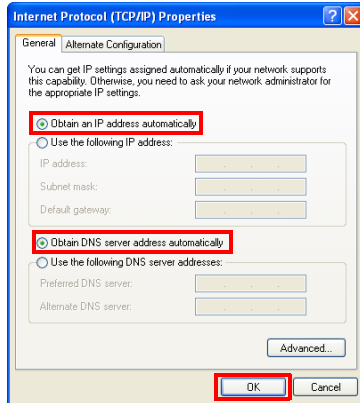

## Installing Wireless Wizard

In order to get your computer ready for wireless connection to the projector, you need to install Wireless Wizard.

### Pre-installation check

1. Check that your system meets the system requirements for operating system and hardware requirements described above.
2. Ensure you have sufficient privileges to install software.
3. Ensure you have uninstalled any previously installed Wireless Wizard.

### Installation

1. Close any other applications being run.
2. Insert the projector software CD into the CD drive of your computer. The software installation menu will display on-screen.

 **If installation does not begin automatically, browse the CD using Windows Explorer and double-click Setup.exe to begin installation.**

3. Click **Install Wireless Wizard** and follow the on-screen instructions to proceed.
4. Restart your computer after you complete the installation.
5. After Wireless Wizard is successfully installed, the  shortcut icon will be created on the Desktop.

## Making wireless presentation

1. Make sure that the distance between the computer(s) and projector is within 10 meters (32 feet).
2. Start up the projector and press the **Source** (or **SOURCE/WIRELESS**) button to switch the input source to **Wireless**. Refer to "**Switching input signal**" on page 26 for more information.

- The following Wireless Connection menu will be projected. If not, press the **Wireless** (or **SOURCE/WIRELESS**) button.

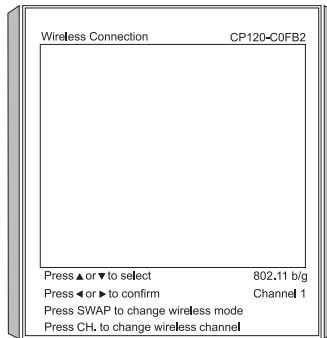

- Start your computer and turn on its wireless function. For more information on how to do this, please refer to the documentation of your computer.
- Double-click on the  icon on Windows Desktop, or click Windows **Start** button and select **(All) Programs -> BenQ Wireless Projector -> Wireless Wizard - Commuter Serial** to open Wireless Wizard. If there are multiple wireless network cards installed on the computer, the following dialog will display prompting you to select a card to use. Click to select a wireless network card from the dialog and then click the **OK** button.

Click to select a wireless network card from the list

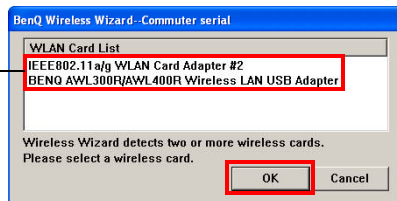

- The following window will follow. Wireless Wizard will detect the wireless capability of the computer (or the wireless network adapter selected in step 5) and display it in the window.

The wireless capability of your computer



- According to the wireless capability of your computer, press the **MODE/SWAP** or **SWAP** button on the projector remote control to change wireless connection to a



suitable mode. The selected mode will display on the projected Wireless Connection menu. Current wireless connection channel will also display.

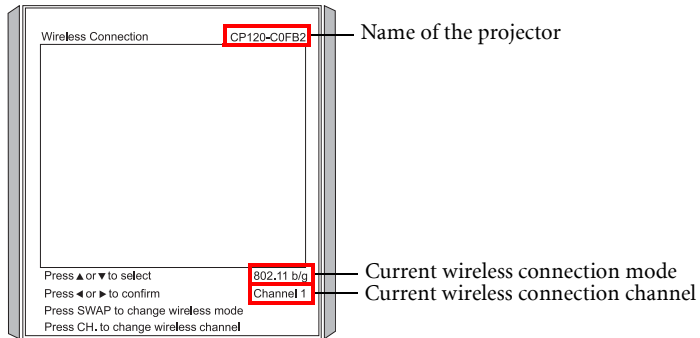

The 802.11 a mode may not be available on the projectors sold in certain countries/areas due to local regulations.

- When the projector is discovered by the computer, the name of the projector and signal strength will appear in the Wireless Wizard window on the computer. If it doesn't, click the **Refresh List** button to try again.

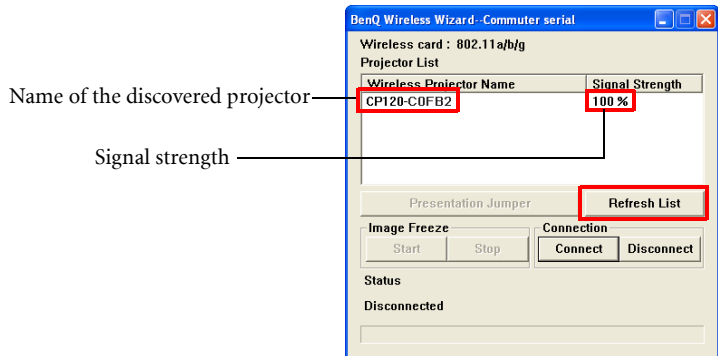

If the projector still can't be found, check the following:

- Is the computer too far away from the projector? Move the computer closer to the projector and click the Refresh List button in the Wireless Wizard window to try again.
- Are there other wireless networks nearby? Press the CH. or AUTO/CH. button to change wireless connection to a different channel and try again.
- Are the TCP/IP settings correctly set? Refer to "[Checking the TCP/IP settings of your computer](#)" on page 29 for details.

- Click on the name of the discovered projector and then click the **Connect** button.

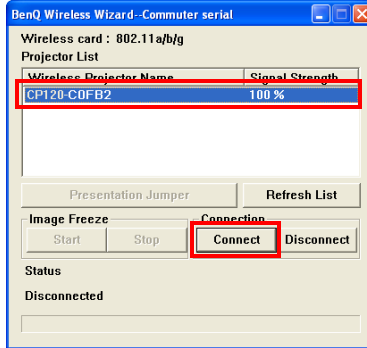

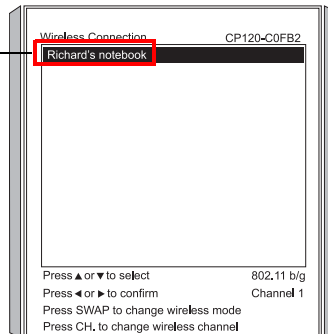

- The computer will start connecting to the projector. This may take a few seconds.
- Repeat Step 2 - Step 6 if you want to establish wireless connections to the projector on other computers. You can connect up to 10 computers to the projector.
- The projector will display a list of all computers currently connected wirelessly to the projector.

Name of the connected computer

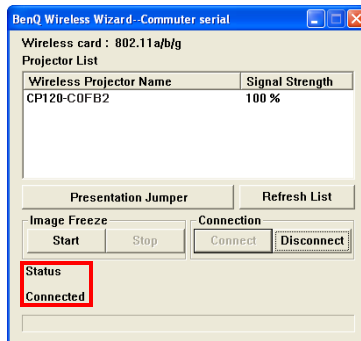

The display resolution of your computer screen will be set to 1024 x 768 automatically to match that of the projector (distortion of image on computer screen may occur, but it will not affect the projected image). The connection status will also display in the Wireless Wizard window on the computer.



The Wireless Wizard icon on Windows Taskbar will also turn from  to  to indicate the status.

13. Press the **▲** or **▼** button on the projector or remote control to select the computer you wish to connect in the projected Wireless Connection menu, and then press the **◀** or **▶** button to use the image from the connected computer.

Alternatively, if no connected computer is currently projecting, you can click the **Presentation Jumper** button in the Wireless Wizard window to have the projector display the image from the computer directly.

## Controlling presentation

### Freezing image

To freeze the image during a wireless presentation, click the Image Freeze **Start** button in the Wireless Wizard window. To release the function, click the Image Freeze **Stop** button.

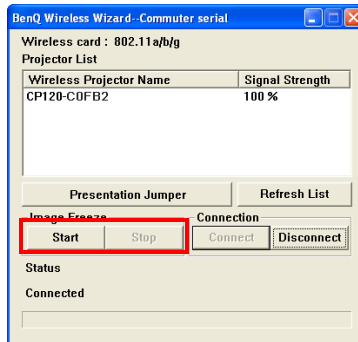

### Swapping presenter

If there are multiple computers connected to the projector, you can use this function to swap projector display among these computers.

#### Method 1: Computer control

1. On the current presenter's computer, click the **Disconnect** button in the Wireless Wizard window.

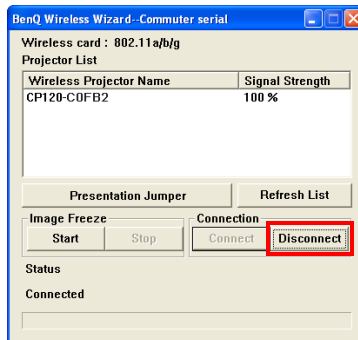

2. On the next presenter's computer, click the **Presentation Jumper** button in the Wireless Wizard window.



## Method 2: Projector control

1. Press the **Wireless** (or **SOURCE/WIRELESS**) button to display the Wireless Connection menu.
2. Press the **▲** or **▼** button on the projector or remote control to select the next presenter's computer in the Wireless Connection menu, and then press the **◀** or **▶** button to project.

## Disconnecting

To disconnect the projector from a computer, click the **Disconnect** button in the Wireless Wizard window.

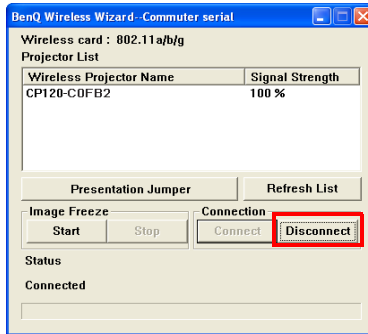





The display resolution of your computer screen will return from 1024 x 768 to its original setting.

# Menu operation

## Menu system

Please note that the on-screen display (OSD) menus vary according to the signal type selected.

Functions available when receiving different signal types...			
Sub-Menu	PC	Wireless	Video / S-Video / Component Video
 <b>Picture</b>	Application Mode Autokeystone Keystone Color Temp Brightness Contrast		Application Mode Autokeystone Keystone Color Temp Brightness Contrast Color *Tint
 <b>Pro-Picture</b>	Auto Resize Aspect Ratio H Position V Position Phase H. Size	Auto Resize Aspect Ratio	Auto Resize Aspect Ratio Sharpness
 <b>Setting</b>	OSD Time Quick Cooling Password Change Password Reset		
 <b>Advance</b>	Mirror Blank Time Source Scan Language Splash Screen High Altitude Mode Auto Off Economic Mode		
 <b>Information</b>	Source Resolution Application Mode Equivalent Lamp Hour		Source System Application Mode Equivalent Lamp Hour

\*When a Video or S-Video signal is connected, the function is only available with NTSC system selected.

# Using the menus

The projector is equipped with on-screen display (OSD) menus for making various adjustments and settings.

There are different menu languages. Before making adjustments, you may choose a suitable OSD language in  **Advance > Language** menu. (Refer to page "4. Advance menu" on page 42 for more details.)

The following example describes the adjustment of the keystone.

1. Press the **Menu** (or **MENU / ▾**) button to turn the on-screen menu on.

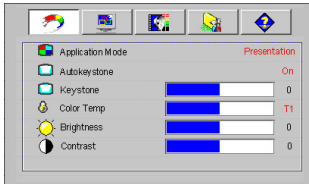

4. Adjust Keystone values by pressing the **Left ◀ / Right ▶** buttons.

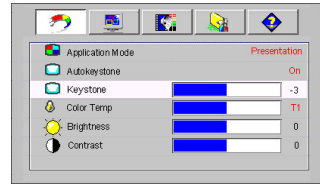

2. Use the **Left ◀ / Right ▶** buttons to select the  **Picture** menu.
3. Press the **▲ Up / ▼ Down** buttons to select **Keystone**.

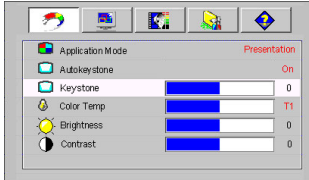

5. Press the **MENU** button to leave and save the settings. The first press leads you back to the submenu and the second press closes the on-screen menu.









# 1. Picture menu

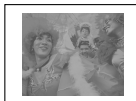

• Some picture adjustments are available only when certain input sources are in use. Unavailable adjustments are not shown on the screen.

• Any custom selected values for Color Temp, Brightness, Contrast, and Color will be reset if you subsequently select an Application mode after adjusting any of their values









Function (default setting/ value)	Description
<p><b>Application Mode</b></p> <p><b>(PC: Presentation)</b></p> <p><b>(YPbPr/ S-Video/ Video: Movie)</b></p>	<p>Pre-defined application modes are provided so you can optimize your projector image set-up to suit your program type.</p> <p> You can use the remote control 'Mode' button to select a predefined application mode. See "<a href="#">Selecting an application mode</a>" on page 26 for details.</p> <p><b>PC Signal Input</b></p> <ol style="list-style-type: none"> <li><b>Brightest Mode:</b> Maximizes the brightness of the projected image. This mode is suitable for environments where extra-high brightness is required, such as in well lit rooms.</li> <li><b>Presentation Mode (Default):</b> Is designed for presentations. The brightness is emphasized in this mode to match PC and notebook coloring.</li> <li><b>Gaming Mode:</b> Is suitable for playing PC-based games in a bright living room.</li> <li><b>sRGB/Photo Mode:</b> Maximizes the purity of RGB colors to provide true-to-life images regardless of brightness setting. It is most suitable for viewing photos taken with an sRGB compatible and properly calibrated camera, and for viewing PC graphic and drawing applications such as AutoCAD.</li> <li><b>Video Mode:</b> Is appropriate for playing movies, video clips from digital cameras or DVs through the PC input for best viewing in a blackened (little light) environment.</li> </ol> <p><b>YPbPr/ S-Video/ Video Signal Input</b></p> <ol style="list-style-type: none"> <li><b>Photo Mode:</b> Is perfect for viewing digital photos taken in daylight with an sRGB compatible and properly calibrated camera, and for viewing Photo CDs. The color saturation and brightness are well-balanced.</li> <li><b>Movie Mode (Default):</b> Is suitable for enjoying colorful movies and TV in a home darkened (not bright) lounge room lighting level environment.</li> <li><b>Cinema Mode:</b> Is suitable for enjoying DVD movies best viewed in a blackened (little light) home cinema or lounge room environment.</li> <li><b>Gaming Mode:</b> Is suitable for playing gamebox-based video games in a normal living room lighting level environment.</li> </ol>
<p><b>Autokeystone (On)</b></p>	<p>If this function is set to <b>On</b>, the projector will detect the tilt angle and correct keystone automatically.</p>

<b>Keystone (0)</b>	Corrects any keystone of the image. Refer to " <a href="#">Correcting keystone</a> " on page 25 for more information.
<b>Color Temp (depends on the selected Application mode)</b>	<p>There are 4 color temperature* settings available.</p> <p> <b>This value will be reset if you subsequently select an Application mode</b></p> <ol style="list-style-type: none"> <li><b>T1:</b> With the highest color temperature, T1 makes the image appear the most bluish white than other settings.</li> <li><b>T2:</b> Makes images appear bluish white.</li> <li><b>T3:</b> Maintains normal colorings for white.</li> <li><b>T4:</b> Makes images appear reddish white.</li> </ol> <p><b>*About color temperatures:</b></p> <p>There are many different shades that are considered to be “white” for various purposes. One of the common methods of representing white color is known as the “color temperature”. A white color with a low color temperature appears to be reddish white. A white color with a high color temperature appears to have more blue in it.</p>
<b>Brightness (depends on the selected Application mode)</b>	<p>Adjusts the brightness of the image. The higher the value, the brighter the image. And lower the value, the darker the image. Adjust this control so the black areas of the image appear as black and that detail in the dark areas is visible.</p> <div style="display: flex; justify-content: space-around; align-items: center;"> <div style="text-align: center;">  <p>-30</p> </div> <div style="text-align: center;">  <p>50</p> </div> <div style="text-align: center;">  <p>+70</p> </div> </div>
<b>Contrast (depends on the selected Application mode)</b>	<p>Adjusts the degree of difference between dark and light in the image. The higher the value, the greater the contrast. Use this to set the peak white level after you have previously adjusted the Brightness setting to suit your selected input and viewing environment.</p> <div style="display: flex; justify-content: space-around; align-items: center;"> <div style="text-align: center;">  <p>-30</p> </div> <div style="text-align: center;">  <p>50</p> </div> <div style="text-align: center;">  <p>+70</p> </div> </div>
<b>Color (depends on the selected input source)</b>	Increases or decreases the color intensity of the image.
<b>Tint (50)</b>	<p>Adjusts the color tones of the image. The higher the value, the more greenish the image becomes. The lower the value, the more reddish the image becomes.</p> <p> <b>When a Video or S-Video signal is connected, the function is only available with NTSC system selected.</b></p>

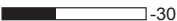



## 2. Pro-Picture menu







 Some picture adjustments are available only when certain input ports are in use. Unavailable adjustments are not shown on the screen.

Function (default setting/ value)	Description
<b>Auto Resize (On)</b>	<p>Automatically resizes the input signal pixel resolution to the native resolution of the projector.</p> <p><b>On:</b> The pixel resolution of the input signal is converted to the native resolution of the projector (1024 x 768). For input signals with lower resolutions, gaps in the pixels are automatically interpolated into the image before being projected. This may distort the image clarity.</p> <p><b>Off:</b> The image is projected as its original resolution, with no pixel conversion. For input signals with lower resolutions, the projected image will display smaller than if resized to full screen. You could adjust the zoom setting or move the projector away from the screen to increase the image size if necessary. You may also need to refocus the projector after making these adjustments.</p>
<b>Aspect Ratio (4:3)</b>	<p>There are two aspect ratio settings.</p> <ul style="list-style-type: none"> <li>• 4 : 3 (for a standard screen)</li> <li>• 16 : 9 (for a wide screen)</li> </ul> <p> <b>16:9 aspect ratio is only sourced through the Component Video input when being fed an appropriate 16:9 aspect signal. See "Connecting a Component Video source device" on page 18 and "Obtaining a preferred projected image size" on page 12 for details.</b></p>
<b>H Position (0)</b>	<p>Adjusts the horizontal position of the projected image.</p> <div style="display: flex; justify-content: space-around; align-items: center;">   </div> <div style="display: flex; justify-content: space-around; align-items: center;"> <div style="text-align: center;">  -30         </div> <div style="text-align: center;">  +30         </div> </div>
<b>V Position (0)</b>	<p>Adjusts the vertical position of the projected image.</p> <div style="display: flex; justify-content: space-around; align-items: center;">   </div> <div style="display: flex; justify-content: space-around; align-items: center;"> <div style="text-align: center;">  -30         </div> <div style="text-align: center;">  +30         </div> </div>
<b>Phase (depends on the selected input source)</b>	<p>This function allows you to adjust the clock phase to reduce image distortion.</p> 
<b>H Size (0)</b>	Adjusts the horizontal width of the image.
<b>Sharpness (15)</b>	Adjusts the image to make it look sharper or softer.

### 3. Setting menu

Function (default setting/ value)	Description
<b>OSD Time (10)</b>	Sets the length of time the OSD will remain active after your last button press. The range is from 5 to 100 seconds.
<b>Quick Cooling (On)</b>	Enables or disables the Quick Cooling function. Selecting <b>On</b> enables the function and projector cooling time will be shortened from a normal 90-second duration to approximately 30 seconds.
<b>Password (off)</b>	<p>This is a selectable function. Selecting <b>On</b> limits use of the projector to only those who know the correct password. When the function is activated for the first time, you have to set a password for it. For more information, refer to <a href="#">"Utilizing the password function" on page 22</a>. Once the password is set and this function is selected, the projector is password-protected. Users who do not know the correct password can not use the projector.</p> <p> <b>WARNING: You will be inconvenienced if you activate the password functionality and subsequently forget the password.</b>  <b>If viewing online, print out this manual and write the password you used in this manual, and keep it in a safe place for later recall.</b></p> <p>The password can be entered by using either the buttons on the projector or the remote control.</p> <p> <b>The password will display on-screen when being input.</b></p>
<b>Change Password</b>	You will be asked to enter the current password before changing to a new one. For more information, refer to <a href="#">"Utilizing the password function" on page 22</a> .
<b>Reset</b>	<p>Returns all settings to the factory preset values.</p> <p> <b>The following settings will still remain: Mirror, Language and Password.</b></p>

## 4. Advance menu

Function (default setting/ value)	Description
<b>Mirror (Floor front)</b>	The projector can be installed behind a screen. In such case, you can use this function to set the correct orientation of the projected image. Refer to " <a href="#">Choosing a location</a> " on page 12 for more information.
<b>Blank Time (20)</b>	Sets the image blank time when the Blank feature is activated, once elapsed, the image will return to the screen.
<b>Source Scan (On)</b>	Sets whether the projector searches automatically for input signals. If the source scan is On, the projector will scan for input signals until it acquires a signal. If the function is not activated, the projector selects the last used input signal.
<b>Language (English)</b>	<p>Language sets the language for the OSD control menus. The available languages are: English, French, German, Spanish, Italian, Russian, Swedish, Dutch, Polish, Czech, Simplified Chinese, Traditional Chinese, Japanese, Korean, Thai, Portuguese and Turkish.</p> <p>Use the <b>Keystone</b>  / <b>Left</b> or <b>Keystone</b>  / <b>Right</b> buttons on the projector, or the <b>Left</b> or <b>Right</b> buttons on the remote control to select your desired language.</p>
<b>Splash Screen (BenQ logo)</b>	Allows you to select which logo screen will display during projector start-up. Three modes are available: Default (BenQ logo), black screen or blue screen.
<b>High Altitude Mode (Off)</b>	<p>A mode for operations in areas like high altitude or high temperature. We recommend you use the High Altitude Mode when your environment is higher than 3000 feet above sea level, or is hotter than 40°C.</p> <p>To activate the High Altitude Mode, select <b>On</b> by pressing <b>Left</b>  / <b>Right</b>  on the projector or remote control. A confirmation message displays. Press <b>Auto</b>.</p> <div data-bbox="341 1007 1002 1142" style="border: 1px solid gray; padding: 5px;"> <p style="color: red; text-align: center;">We recommend you use the High Altitude Mode by selecting On when your environment is higher than 3000 feet, or is hotter than 40°C.</p> <p style="text-align: center; color: blue;">Do you want to turn on High Altitude Mode?</p> <p style="text-align: center;">Yes  No </p> </div> <p>Next time you turn on the projector, it will show a message pictured below as a reminder during the start-up.</p> <div data-bbox="341 1209 1002 1329" style="border: 1px solid gray; padding: 5px;"> <p style="text-align: center; color: red;">Current Status</p> <p style="text-align: center; color: blue;">High Altitude Mode <b>On</b></p> <p style="text-align: center; color: blue; font-size: small;">This mode is used for protecting projector from extreme environment and may cause high fan speed.</p> </div> <p>Operation under "High Altitude Mode" may cause a higher decibel operating noise level because of increased fan speed necessary to improve overall system cooling and performance.</p>

<b>High Altitude Mode (Off)</b>	If you use this projector under other extreme conditions excluding the above, it may display auto shut-down symptoms, which is designed to protect your projector from over-heating. In cases like this, you should switch to High Altitude mode to solve these symptoms. However, this is not to state that this projector can operate under any and all harsh or extreme conditions, or whenever the projector will be used for extended periods of time (>10hours) without shutdown.
<b>Auto Off (Off)</b>	This function allows the projector to turn off automatically if no input signal is detected after a set period of time. Press <b>Left</b> ◀ / <b>Right</b> ▶ on the projector or remote control to set the duration before the projector is turned off. Selecting <b>Off</b> disables this function.
<b>Economic Mode (Off)</b>	Use this mode to reduce system noise and reduce power consumption by 20%. If this mode is activated, the light output will be reduced and result in darker projected images.  <b>Setting the projector in Economic mode extends the lamp timer automatic shutdown feature. For more information on how the total lamp hour is calculated, see "Calculation of lamp hour" on page 46.</b>

## 5. Information Menu

This menu shows you the current operating status of the projector.

 **Some picture adjustments are available only when certain input ports are in use. Unavailable adjustments are not shown on the screen.**

Function	Description
<b>Source</b>	Shows the current signal source.
<b>Resolution</b>	Shows the native resolution of the input signal.
<b>Application Mode</b>	Shows the selected application mode in the  <b>Picture</b> menu.
<b>Equivalent Lamp Hour</b>	Displays the number of hours the lamp has been used.
<b>System</b>	Shows the Video input system format, NTSC, SECAM or PAL.

# 6 Maintenance

## Care of the projector

Your projector needs little maintenance. The only thing you need to do on a regular basis is to keep the lens clean.

Never remove any parts of the projector except the lamp. Contact your dealer if other parts need replacing.

### Cleaning the lens

Clean the lens whenever you notice dirt or dust on the surface.

- Use a canister of compressed air to remove dust.
- If there is dirt or smears, use lens-cleaning paper or moisten a soft cloth with lens cleaner and gently wipe the lens surface.

 **Never rub the lens with abrasive materials.**

### Cleaning the projector case

Before you clean the case, turn the projector off using the proper shutdown procedure as described in "[Shutdown](#)" on [page 27](#) and unplug the power cord.

- To remove dirt or dust, wipe the case with a soft, dry, lint-free cloth.
- To remove stubborn dirt or stains, moisten a soft cloth with water and a neutral pH detergent. Then wipe the case.

 **Never use wax, alcohol, benzene, thinner or other chemical detergents. These can damage the case.**

### Storing the projector

If you need to store the projector for an extended time, please follow the instructions below:

- Make sure the temperature and humidity of the storage area are within the recommended range for the projector. Please refer to "[Specifications](#)" on [page 53](#) or consult your dealer about the range.
- Retract the adjuster feet.
- Remove the batteries from the remote control.
- Pack the projector in its original packing or equivalent.

### Transporting the projector

It is recommended that you ship the projector with its original packing or equivalent. When you carry the projector yourself, please use the original box or provided soft carry case.

## Calculation of lamp hour

When the projector is in operation, the duration (by hours) of lamp usage is automatically calculated by the built-in timer. The method of calculating the equivalent lamp hour is as follows:

Total (equivalent) lamp hour = hours used in Economic mode + hours used in normal mode

☞ See "**Economic Mode (Off)**" on page 43 for more information on Economic mode.

The lamp hour in Economic mode is calculated as 2/3 of that in normal mode. That is, using the projector in Economic mode helps to extend the lamp hour by 1/3.





## Warning message

When the **Lamp indicator** lights up red or a message appears suggesting it is time to replace the lamp, please install a new lamp or consult your dealer. An old lamp may cause a malfunction in the projector and in some instances the lamp may explode.

For more detailed information on projector warnings, please refer to "**Indicators**" on page 49.

⚠ **The Lamp indicator light and Temperature warning light will light up if the lamp becomes too hot. Turn the power off and let the projector cool for 45 minutes. If the Lamp or Temp indicator still lights up after turning the power back on, please contact your dealer.**

The following Lamp warning displays will remind you to change the lamp.

Message	Status
	The lamp has been in operation for 1800 hours. Install a new lamp for optimal performance. You may continue to operate the projector until the 1950 hour lamp warning appears.
	The lamp has been in operation for 1950 hours. A new lamp should be fitted to avoid the inconvenience when the projector runs out of lamp time.
	The lamp has been in operation for over 2000 hours. This message will flash in the center of the screen for about 30 seconds together with the <b>Lamp indicator</b> lighting up red for 40 seconds.
	If this warning message displays, the projector will shutdown in 40 seconds. The lamp <b>MUST</b> be replaced before the projector will operate normally.

# Replacing the lamp



• To reduce the risk of electrical shock, always turn the projector off and disconnect the power cord before changing the lamp.

• To reduce the risk of severe burns, allow the projector to cool for at least 45 minutes before replacing the lamp.

To reduce the risk of injuries to fingers and damage to internal components, use caution when removing lamp glass that has shattered into sharp pieces.

To reduce the risk of injuries to fingers and/or compromising image quality by touching the lens, do not touch the empty lamp compartment when the lamp is removed.

This lamp contains mercury. Consult your local hazardous waste regulations to dispose of this lamp in a proper manner.

Step 1. Turn the power off and disconnect the projector from the wall socket.

Step 2. Protect the projector's surface by clearing a flat open area on your desk and placing a soft item on the desk for padding.

Step 3. Turn the projector over. Then loosen the screws.

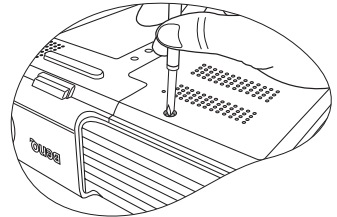

Step 4. Remove the lamp cover. If the lamp is hot, avoid burns by waiting for 45 minutes until the lamp has cooled.

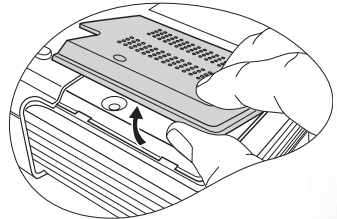

Step 5. Loosen the screw fixing the lamp to the projector. If the screw is not loosened completely, the lamp cannot be removed. Be careful not to lose the screw as it is needed to hold the replacement lamp in place. It is strongly recommended that you use a magnetic-head screwdriver.

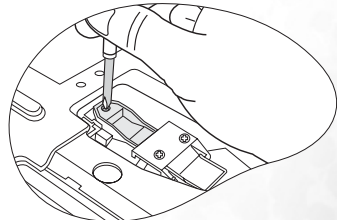

Step 6. Lift the handle so that it stands up. Use the handle to slowly pull the lamp out of the projector.

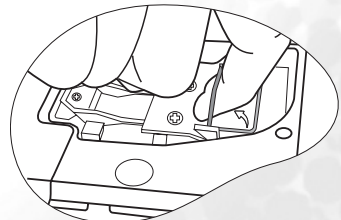



- ☞ • Pulling it too quickly may cause the lamp to break and scatter broken glass in the projector.
- Do not place the lamp in locations where water might splash on it, children can reach it, or near flammable materials.
- Do not insert your hands into the projector after the lamp is removed. If you touch the optical components inside, it could cause color unevenness and distortion of the projected images.

Step 7. Insert a new lamp. Ensure the handle is fully laid flat and locked in place. Reinsert and tighten the screw firmly.

- ☞ • Loose screw may cause a bad connection, which could result in malfunction.
- Do not over tighten the screw.

Step 8. Reinstall the lamp cover and tighten the screws.

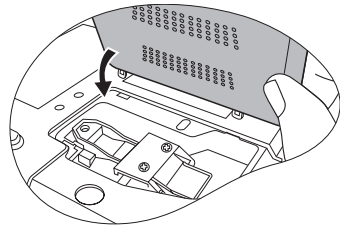

Step 9. Restart the projector.

- ☞ Do not turn the power on with the lamp cover removed.

Step 10. **Resetting the lamp counter**

- ☞ Do not reset if the lamp is not replaced as this could cause damage.

- Press and hold the **BLANK / ^ Up** button on the projector for 5 seconds to display the total used lamp time.
- Press the **AUTO** (or **AUTO/CH.**) button to reset the lamp hour to "0".
- Wait about 5 seconds to let the OSD disappear.

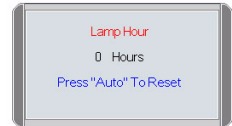

## Temperature information



When the **TEMPerature** warning light flashes, it is warning you of the following possible problems:













- The internal temperature is too high.
- The fans are not working.

Turn the projector off and contact qualified service personnel for further help. For more detailed information, please refer to "[Indicators](#)" on page 49.

# Indicators

## Illustration

- **Blank -** : Light OFF
- **O** : Orange light
-  : Light flashing
- **R** : Red light
-  : Light ON
- **G** : Green light

Light			Status & Description
POWER	TEMPerature	LAMP	
<b>Power events</b>			
	-	-	<ul style="list-style-type: none"> <li>• The projector needs to cool after the power is turned off.</li> <li>• The projector is in the startup cooling process.</li> </ul>
	-	-	Stand-by mode.
	-	-	The <b>Power indicator light</b> is flashing during powering up.
	-	-	The projector is under normal operation.
<b>Lamp events</b>			
	-		It is warning you that lamp usage has exceeded 2000 / 3000 (Economic mode) hours. Replace the projection lamp with a new one immediately.
-	-		The lamp is not properly attached or the lamp is damaged. Please contact your dealer for assistance.
<b>Thermal events</b>			
-		-	The projector has shutdown automatically. If you try to re-start the projector, it will shutdown again. Please contact your dealer for assistance.
-			
-			

-	R	O
R	R	R
R	R	G
R	R	O
G	R	R
G	R	G
G	R	O
O	R	R
O	R	G
O	R	O
-	G	R
-	G	G

The projector has shutdown automatically. If you try to re-start the projector, it will shutdown again. Please contact your dealer for assistance.

# 7 Troubleshooting

## ② The projector does not turn on.

Cause	Remedy
There is no power from the power cable.	Plug the power cord into the AC inlet on the projector, and plug the power cord into the power outlet. If the power outlet has a switch, make sure that it is switched on. See " <a href="#">Start up</a> " on page 21 for details.
Attempting to turn the projector on again during the cooling process.	Wait until the cooling down process has completed. See " <a href="#">Shutdown</a> " on page 27 for details.

## ② No picture.

Cause	Remedy
The video source is not turned on or connected correctly.	Turn the video source on and check that the signal cable is connected correctly. See " <a href="#">Connection</a> " on page 16 for details.
The projector is not correctly connected to the input source device.	Check the connection. See " <a href="#">Connection</a> " on page 16 for details.
The input signal has not been correctly selected.	Select the correct input signal with the <b>SOURCE</b> button on the projector or remote control. See " <a href="#">Switching input signal</a> " on page 26 for details.
The lens cover is not open.	Slide open the lens cover.

## ② Image is unstable.

Cause	Remedy
The connection cables are not securely connected to the projector or the signal source.	Correctly connect the cables to the appropriate terminals. See " <a href="#">Connection</a> " on page 16 for details.

## ② Image is blurred.

Cause	Remedy
The projection lens is not correctly focused.	Adjust the focus of the lens using the focus ring. See " <a href="#">Fine-tuning the image size and clarity</a> " on page 24 for details.
The projector and the screen are not aligned properly.	Adjust the projection angle and direction as well as the height of the unit if necessary. See " <a href="#">Obtaining a preferred projected image size</a> " on page 12 for details.
The lens cover is not open.	Slide open the lens cover.

⑦ **Remote control does not work.**

Cause	Remedy
The battery is out of power.	Replace the battery with a new one.
There is an obstacle between the remote control and the projector.	Remove the obstacle.
You are too far away from the projector.	Stand within 6 meters (~ 20 feet) of the projector.

⑦ **Unable to use wireless connection.**

Cause	Remedy
The wireless connection modes between the projector and computer do not match.	Change the wireless connection mode on the projector by pressing the SWAP or MODE/ SWAP button according to the wireless capability of your computer.
The wireless settings are not properly configured.	Check the wireless settings of your computer. See " <a href="#">Preparing your computer for wireless connection</a> " on page 29 for details.
The wireless signal is too weak.	Move the computer to a location with better signal reception.
There are other wireless networks nearby.	Press the CH. or AUTO/CH. button to change wireless connection to a different channel and try again.

# 8 Specifications

## projector specifications

 All specifications are subject to change without notice.

### General

Product name	Digital Projector
Model name	CP120

### Optical

Resolution	1024 x 768 XGA
Display system	1-CHIP DMD
Lens F/Number	F=2.6 to 2.96, f= 25.8 to 30 mm
Lamp	132W lamp

### Electrical

Power supply	AC100 ~ 240V, 3.5A, 50/60 Hz (Automatic)
Power consumption	190W (Max)

### Mechanical

Dimensions	218 mm (W) x 61 mm (H) x 167 mm (D)
Weight	2.9 lb (1.3 Kg)

### Input terminal

Computer input	
RGB input	D-sub 15-pin (female) x 1
Video signal input	
S-VIDEO	Mini DIN 4-pin port x 1
VIDEO	RCA x 1
HDTV signal input	D-sub <--> Component RCA jack x 3, through RGB input

### Output

USB mouse connector	Mini B type x 1
---------------------	-----------------

### Wireless connection

Compatibility	IEEE 802.11 a/b/g
---------------	-------------------

 **The 802.11 a mode may not be available on the projectors sold in certain countries/areas due to local regulations.**

### Environmental requirements

Operating temperature	0°C - 40°C at sea level
Operating relative humidity	10% - 90% (without condensation)
Operating altitude	<ul style="list-style-type: none"><li>• 0 - 3000 feet at 0°C - 40°C</li><li>• 3000 - 6000 feet at 0°C - 30°C</li><li>• 6000 - 10000 feet at 0°C - 23°C</li></ul>

# Dimensions

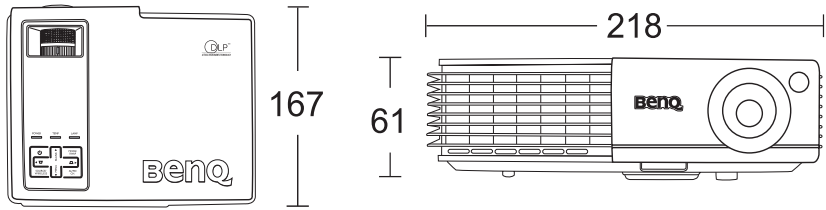

Unit: mm

# Timing chart

Supported timing for PC input

Resolution	Horizontal Frequency (kHz)	Vertical Frequency (Hz)	Pixel Frequency (MHz)	Mode
720 x 400	37.927	85.039	35.500	720 x 400_85
640 x 480	31.469	59.940	25.175	VGA_60
	37.861	72.809	31.500	VGA_72
	37.500	75.000	31.500	VGA_75
	43.269	85.008	36.000	VGA_85
800 x 600	37.879	60.317	40.000	SVGA_60
	48.077	72.188	50.000	SVGA_72
	46.875	75.000	49.500	SVGA_75
	53.674	85.061	56.250	SVGA_85
1024 x 768 (native)	48.363	60.004	65.000	XGA_60
	56.476	70.069	75.000	XGA_70
	60.023	75.029	78.750	XGA_75
	68.667	84.997	94.500	XGA_85
1280 x 800	64	60	108	WXGA
1280 x 1024	63.981	60.020	108.000	SXGA3_60
1400 x 1050	63.973	60.012	118.094	SXGA+_60
1440 x 900	64	60	108	WXGA+

 To achieve the best quality projected image, please use the projector's native resolution of 1024 x 768.

## Supported timing for Component-YP<sub>b</sub>P<sub>r</sub> Input

Signal Format	Horizontal Frequency (kHz)	Vertical Frequency (Hz)
480i(525i)@60Hz	15.73	59.94
480p(525p)@60Hz	31.47	59.94
576i(625i)@50Hz	15.63	50.00
576p(625p)@50Hz	31.25	50.00
720p(750p)@60Hz	45.00	60.00
720p(750p)@50Hz	37.50	50.00
1080i(1125i)@60Hz	33.75	60.00
1080i(1125i)@50Hz	28.13	50.00

## Supported timing for Video and S-Video inputs

Video mode	Horizontal Frequency (kHz)	Vertical Frequency (Hz)	Color sub-carrier Frequency (MHz)
NTSC	15.73	60	3.58
PAL	15.63	50	4.43
SECAM	15.63	50	4.25 or 4.41
PAL-M	15.73	60	3.58
PAL-N	15.63	50	3.58
PAL-60	15.73	60	4.43
NTSC4.43	15.73	60	4.43



# Warranty

## Limited warranty

BenQ warrants this product against any defects in material and workmanship, under normal usage and storage.

Proof of purchase date will be required with any warranty claim. In the event this product is found to be defective within the warranty period, BenQ's only obligation and your exclusive remedy shall be replacement of any defective parts (labor included). To obtain warranty service, immediately notify the dealer from which you purchased the product of any defects.

**Important:** The above warranty shall be void if the customer fails to operate the product in accordance with BenQ's written instructions, especially the ambient humidity must be in-between 10% and 90%, temperature in-between 0°C and 40°C, altitude lower than 10000 feet, and avoiding to operate the projector in a dusty environment. This warranty gives you specific legal rights, and you may have other rights which vary from country to country.

For other information, please visit [www.BenQ.com](http://www.BenQ.com).

# 10 Regulation statements

## FCC statement

**CLASS B:** This equipment generates, uses and can radiate radio frequency energy and, if not installed and used in accordance with the instructions, may cause harmful interference to radio communications. However, there is no guarantee that interference will not occur in a particular installation. If this equipment does cause harmful interference to radio or television reception, which can be determined by turning the equipment off and on, the user is encouraged to try to correct the interference by one or more of the following measures:

- Reorient or relocate the receiving antenna.
- Increase the distance between the equipment and receiver.
- Connect the equipment into an outlet on a circuit different from that to which the receiver is connected.
- Consult the dealer or an experienced radio/TV technician for help.

## EEC statement

This machine was tested against the 89/336/EEC (European Economic Community) for EMC (Electronic Magnetic Compatibility) and fulfills these requirements.

## MIC statement

**B class equipment (Household purpose info/telecommunications equipment)**

As this equipment has undergone EMC registration for household purpose, this product can be used in any area including residential area.

<Memo>