

# Multi-Function LCD Projector **MP-50E**

## User's Manual

**English**

Deutsch

Français

Española

---

Thank you for purchasing the Avio MP-50E LCD Projector.  
Please read this manual carefully in order to use the projector properly.  
After reading this, please keep it in a safe place together with the warranty sheet.

## ● Features

- **Three handy features in a single body. The projector for the multimedia age**
  1. Documents, catalogs and other printed matter can be projected directly from the scanner. This frees the user from the need to make OHP film inserts for each document.
  2. Personal computer screens can be projected. This allows the user to make detailed presentations using information on a personal computer.
  3. Videos and DVD images can be projected as they are. This aids the user in making visually appealing presentations.
- **Easy-to-understand and simple operation**

Projection of printed matter, personal computer screens and video images can be selected at the push of a button.
- **High cost effective resource-saving design**

OHP film inserts no longer need to be made, which saves wasted time and expense.
- **“Super-Slim” Stylish Body**

Full OHP functions based on advanced technology built in to a super-slim chassis. It fits anywhere, when you’re using it, and when you need to put it away.
- **Expressive color images**

The projector is equipped with a high-resolution 2 million pixel single-array color CCD camera. This allows subtle midtones in color documents to be reproduced faithfully and sharp as projected images in full color (16,770,000 colors).
- **Enlarged display without changing the size of the projected image**

When projecting documents such as catalogs and word-processor documents containing small text that have not been made specially for presentations, the document can be enlarged without changing the size of the projected image for easier viewing.
- **Provided with display functions for compressed or enlarged PC screen**

Screens of resolution more than 1024 x 768 dots are displayed compressed to 1024 x 768 dots without any loss in character quality. Lower resolutions such as 640 x 480 can also be enlarged to 1024 x 768 dots.

## ● About Trademarks

IBM and PC/AT are trademarks or registered trademarks of International Business Machines Corporation.

Macintosh and Power Book are trademarks of Apple Computer Inc.

Windows is a trademark of U.S. Microsoft Corporation.

---

# Warnings and Safety Precautions

## ● Warning Symbols

To alert the user to important safety precautions, the following symbols are used in this manual and on the product. Make sure you understand what these symbols mean before operating the projector.



: Death or serious injury may result if this warning is ignored.



: Injury or damage to the equipment may result if this warning is ignored.

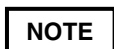

: This indicates an item that you should take care of when handling your projector.



: This symbol alerts the user to high voltage that could cause electric shock.

## ● Safety Precautions



- **If a fault occurs:**
  - If you detect smoke, or a strange smell or sound, immediately disconnect the power cord.  
It is dangerous to continue using the projector after a fault occurs. Return the projector to the dealer where it was purchased for repair.
- **Avoid placing the projector near dangerous substances.**
  - Make sure that no metallic or flammable material can get into the projector through the air vents.
  - Do not place any objects containing water on top of or next to the projector.
- **If foreign matter gets inside the projector:**
  - If foreign matter such as water or metal gets inside, immediately disconnect the power cord.  
It is dangerous to continue using the projector when foreign matter gets inside. Return the projector to the dealer where it was purchased for servicing.
- **Do not remove the cabinet.**
  - Do not remove the cabinet. There are high-voltage components inside and touching these parts could cause electric shock, or damage the equipment.
- **Handle the power cable safely.**
  - Do not place any heavy objects on top of the power cord.  
Damage to the power cord can cause wire breakage, fire, or electric shock.
  - Do not pull the power cord when disconnecting the power plug.  
Pulling the cable may break the wires or cause fire or electric shock. Always hold the plug itself when pulling it out of the power outlet.
  - Do not damage the power cable. If the power cord is damaged (e.g. the core is exposed or cut), contact the sales office of purchase. (charged) it could cause fire or electric shock if you continue using the damaged power cord.

- 
- **Do not look through the lens.**
    - Do not look through the lens into the projector during operation. The powerful rays passing through the lens could damage the eyes.
  - **Do not put the projector in unstable places.**
    - Do not put the projector in unstable places such as on unstable desks or slopes.  
Doing so could cause the projector to drop or turn over, resulting in injury.
  - **Do not use any voltages other than specified.**
    - Do not use any voltages other than specified. Doing so could cause fire or electric shock.
  - **Do not disassemble the alkaline batteries**
    - Do not short-circuit, disassemble, or burn the alkaline batteries.  
Doing so could cause the alkaline solution to leak, which could cause eye injury, as well as cause a fire or damage the surrounding area due to heat or explosion. If the alkaline solution touches skin or clothes, wash them with clean water. If it get into eyes, immediately wash them with clean water and see a doctor.
  - **Do not bump the glass surface**
    - Do not bump the glass surface over the scanner. Doing so may break the glass, resulting in injury.
  - **Do not touch the air vents or lamp cover**
    - The air vents, lamp cover, and peripheral surfaces may be hot during operation or just after the light is turned off.  
Do not touch those for a long time.
  - **Do not block the lens front**
    - Do not block the lens front during operation.  
The powerful rays passing through the lens may cause fire or burns if you put anything in front of the lens or block the lens with your hand during operation.



- **Installation**
  - Avoid installing the projector in places where it may be exposed to:
    - Strong vibrations
    - Soot or steam
    - Direct sunlight or near a heater (35°C/95°F or higher)
    - High humidity or dust
    - Extreme cold (0°C/32°F or lower)
    - Strong magnetic or electric field generated from a nearby appliance
    - Wobbling on an unstable surface
- **Do not block the air vents.**
  - Do not block the air vents with cloth or an object.  
When you put anything around the unit, be sure to ensure a space of 10 cm/4 inches or more between the unit and the air vent. Be sure to prevent paper or cloth from blocking the air vent at the bottom of the unit. If blocked, the internal temperature may increase, resulting in malfunctions.
- **Do not bump the projector.**
  - Avoid bumping the projector when moving or handling. Shocks can cause damage.

- 
- **Care of the projector**
    - To prevent risk of accidents, always disconnect the power plug before cleaning the projector.
    - Clean the lens surface with a commercial blower or lens cleaning paper. Wiping with tissue paper or a handkerchief can damage the lens.
    - To clean the cabinet, operation panel, and glass surface, wipe gently with a soft cloth. For particularly dirty spots, soak the cloth in a neutral detergent mixed in water, wring out well and wipe off the dirt, then use a dry cloth to wipe dry.
    - Do not wipe the projector with any volatile solvent such as benzine or thinner. Solvents can cause surface deformation or flaking of the paint. If using an impregnated cloth, follow the instructions.
  - **Avoid scratching the glass surface.**
    - Take care not to scratch the glass surface of the scanner with hard or pointed objects. Scratches on the glass may distort the projected image.
  - **Batteries**
    - When inserting batteries in the remote control, note the polarity (plus and minus signs) and insert correctly as indicated. Inserting a battery in a wrong direction can cause rupture or leakage, and could result in fire and injury or soil the surrounding area.
    - Do not use batteries other than the type specified for the equipment. Do not use a new battery and an old battery together. Incorrect battery usage could result in rupture or leakage, and could cause fire and injury.
    - Do not heat, break open, burn, or immerse the batteries. Battery rupture or leakage could cause fire and injury.
  - **Servicing and cleaning**
    - Have the internal components cleaned by a retailer about once a year. There is a risk of fire or faulty operation if the inside of the projector gets dusty and is not cleaned for a long time. For best results, the projector should be serviced before the wet season brings damp conditions. Cleaning charges are at the discretion of the retailer.
  - **If not using the projector for a long period:**
    - If you do not plan to use the projector for a long time, disconnect the power cord for safety.
  - **Disposal**
    - Follow the recommendations of your local authority when disposing of the projector.
  - **Transporting the projector**
    - Use the special packaging when transporting the projector. The manufacturer cannot accept responsibility in the event of damage or accident if other packaging is used.
    - Use the special packaging no more than two times. Repeated usage reduces the shock absorbency of the packaging and can lead to damage or accident.
    - Contact the retailer if you require new packaging.
  - **Lamp implosion**
    - An AC type New Super High pressure lamp is used in this projector and it is rare for the lamp to explode during use. The lamp is also designed to forcibly turn off because there is a high possibility that the lamp will break if it is used beyond the lamp usage of 1500 hours (Refer to pages E-54 and E-55).

---

**Note the following things**

- A noise occurs because the internal pressure of the New Super High pressure lamp gets extremely high.  
The unit is designed so that no pieces of glass come out of it when the lamp explodes.
- However, the gas inside of the lamp can escape and looks like white smoke. It will not cause any fire.

**Remedy**

- If a lamp explodes in a product, there will be pieces of lamp inside. Do not replace the lamp. Return the product to the sales office or agent of purchase. Even though the lamp has exploded, never try to replace the lamp by yourself. The lamp pieces could cause injury.
- **Replacing the lamp**
  - Be sure to turn the lamp off and disconnect the power cord when the fan stops, and wait an hour or more before replacing the lamp.  
Replacing the lamp during operation or just after the power is turned off may cause burns due to heat.  
Refer to “Lamp Unit Replacement” on page E-54 for the procedure.
- **Replacing / cleaning the air filter**
  - Be sure to disconnect the power cord when the cooling fan stops before removing the air filter.  
Removing the air filter while the cooling fan is rotating could cause a burn.  
Refer to “Cleaning the Air Filter” on page E-56 for the procedure.
- **Avoiding malfunctions and accidents**
  - Adjust the Adjustable feet to keep the projector horizontal.  
Using the projector in a tilted status may cause injury if it turns over. Refer to “Adjusting the Tilt” on page E-18 for the adjusting procedure.
- **Do not disassemble the manganese batteries**
  - Do not short-circuit, disassemble, or burn the manganese batteries.  
Doing so could cause the batteries to generate heat or explode due to the leaked solution, resulting in fire, injury, or damages to the surrounding area.
- **Do not do the followings**
  - Do not put anything heavy on the projector.
  - Do not step on the projector, rack, or stand. Do not hold or hang on the projector.  
Doing so could cause the projector to turn over or break, resulting in injury. Especially be careful if small children are near.
  - Do not use the rack unless the casters are locked when placing the projector on a rack with casters.  
Doing so may cause the projector to move or turn over, resulting in injury.
  - Do not turn the lamp on/off within one minute after it is turned off/on. Extremely high voltage is generated in the lamp just after it is turned on. Turning the lamp on/off too frequently could cause the lamp to deteriorate or break, resulting in malfunctions of the projector.
  - Do not project an image with the lens cap attached.
- **Moving the projector**
  - Be sure careful of the glass surface when moving the projector while holding the handles with both hands.
  - If not inserted fully, the materials cover may get loose and fall off while you carry it.

- 
- **Care of the power cord and plug**
    - Do not put the power cord near a heater. Doing so could cause the sheath of the cable to melt down, resulting in fire or electric shock.
    - Do not connect or disconnect the power cord with wet hands. Doing so could cause electric shock.
    - Be sure to pull out the power cord and disconnect any cable connections between units and release the anti-theft lock before moving the projector. Moving the projector with cables connected may cause fire or electric shock if the cables are damaged.
    - If you do not plan to use the projector for a long time, disconnect the power cord for safety.
  
  - **DO NOT REMOVE ANY SCREWS except the lamp cover screw and two lamp unit screws. You could receive an electric shock.**

### What's in the Box?

**Make sure your box contains everything listed. If any pieces are missing, contact your dealer. Please save the original box and packing materials if you ever need to ship your MP-50E Projector.**

MP-50E Projector (1)  
Remote control(1)  
Power codes (2)



For North America

**Three-pin type for U.S.A and Canada;**

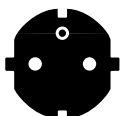

For Europe

**Two-pin type for Europe.**

**PC Signal cable (1)**  
**Lens cap(1)**  
**Batteries(2) (AA×2)**  
**Documents:**  
User's manual (1)

---

# Contents

Part Names and Functions .....	E-9
Projector .....	E-9
Terminal Panel .....	E-11
Buttons and Indicator Lights .....	E-12
Remote Controller .....	E-15
Remote Control Operations .....	E-17
Battery Replacement .....	E-17
How to Install the Projector .....	E-18
Installation Sequence .....	E-18
Adjusting the Tilt .....	E-18
Projection Distance and Projected Image Size .....	E-19
Typical Installation .....	E-20
Compensating Keystone .....	E-21
Connecting to a Personal Computer .....	E-22
Connecting to a Personal Computer .....	E-22
About RGB Video Output .....	E-23
When Images on the Personal Computer Screen are not Projected .....	E-24
Input Signal Compatibility Table (PC video input terminal) .....	E-25
Connecting to a Video Source or DVD Player .....	E-28
Basic Operation .....	E-29
Preparation .....	E-29
Basic Operations in the OHP Mode .....	E-30
Basic Operation of PC or Video Input .....	E-37
How to Quit .....	E-41
Performing Various Adjustments .....	E-42
Menu Structure .....	E-42
Description of Menu Items .....	E-43
Basic Operation .....	E-47
Quick Menu .....	E-51
Description of Menu Items .....	E-51
Maintenance .....	E-52
Fault Protection .....	E-52
Lamp Unit Replacement .....	E-54
Cleaning the Air Filter .....	E-56
Troubleshooting .....	E-57
Repair Service .....	E-58
Specifications .....	E-59

\* Company names and product names herein are trademarks and registered trademarks of those companies.



# Part Names and Functions

## Projector

### Handle

■ **Extended**

Press lightly on the left side of the handle and it rotates 180° and comes out.

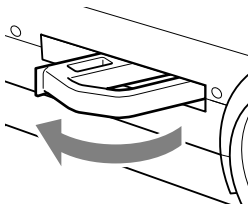

■ **Retracted**

Rotate the handle while pressing on its right side to store it.

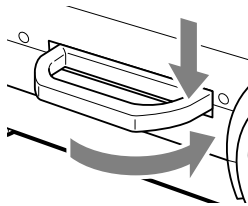

Remote Control Sensor

### Materials Cover

The scanner and printed matter is located under this cover. See page E-31.

### Operation panel

Buttons for operating the projector are located here. See page E-12.

### Speakers

### Air Vent A (air filter) (side of main unit)

Air is taken in through this vent. An air filter is provided to prevent dust from getting inside the projector. See page E-56.

### Anti-theft Lock

See the NOTE below.

Adjustable Feet

### Focus adjuster

Turn this to adjust the focus. See page E-30.

### Projection Lens

Images are projected through this lens. \* Be sure to remove the lens cap when projecting images.

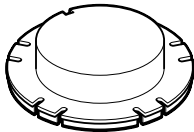

Lens cap

### Tilt Adjustment Buttons

Press this to adjust the adjustable feet. See page E-18.

### Adjustable Feet

These feet are for adjusting the tilt angle as well as the left and right balance of the projected image. Turning them counterclockwise raises the main unit, and turning them clockwise lowers the main unit. See page E-18.

### Zoom lever

Turn this ring to adjust the screen size. See page E-30.

### NOTE

#### About the anti-theft lock

The anti-theft lock is compatible with Kensington security cable lock. Contact the following for more information about the products.

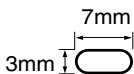

Kensington Technology Group  
 2000 Alameda de las Pulgas  
 Second Floor  
 San Mateo, California 94403-1289, U.S.A.  
 Phone: (650) 572-2700  
 Fax: (650) 572-9675  
 URL: <http://www.kensington.com>

**Scanner**

Place documents or printed matter here to project images when OHP is selected.  
See page E-31

**Speakers**

**Power (Cord connector)**  
Connect the power cord into this terminal.  
See page E-20.

**Sensor**

**Adjustable Feet**

**Adjustable Feet**

**Air Vent B**

Air is discharged from the inside to the outside through this vent.

**I/O Terminal Panel**

Connection terminals for a PC or video source are located here.  
See page E-11.

**Lamp Unit Cover**

(bottom of main unit)

The scanner lamp unit is housed inside this cover.  
See page E-54.

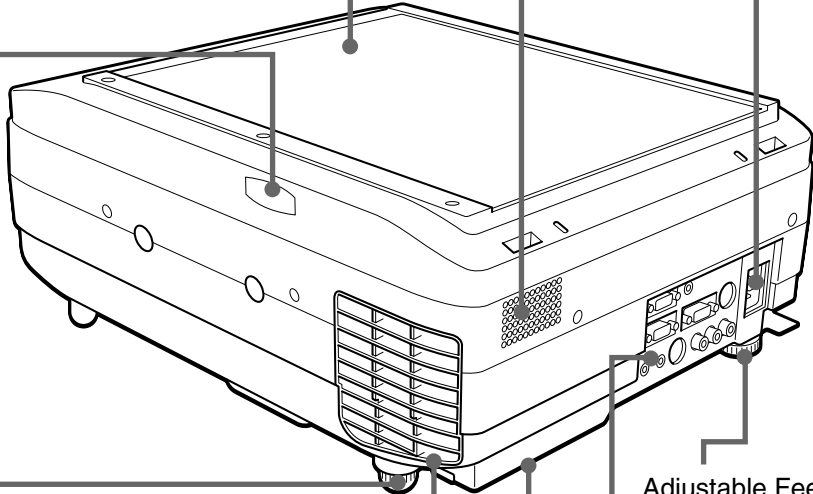

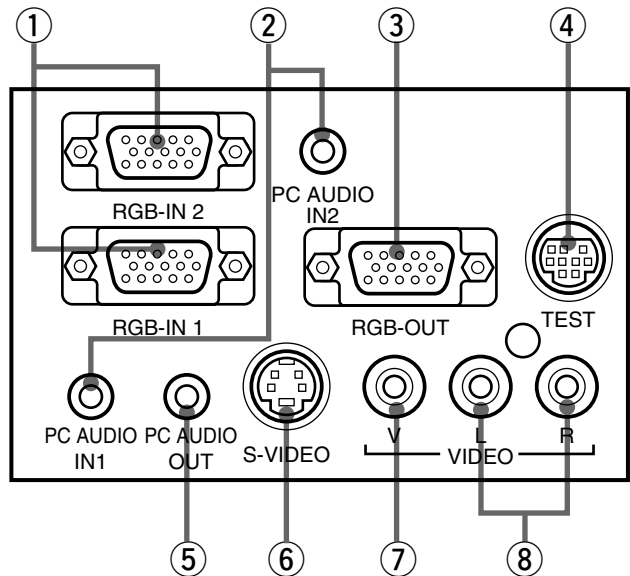
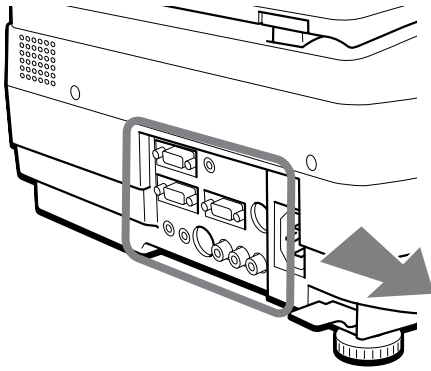

## Terminal Panel



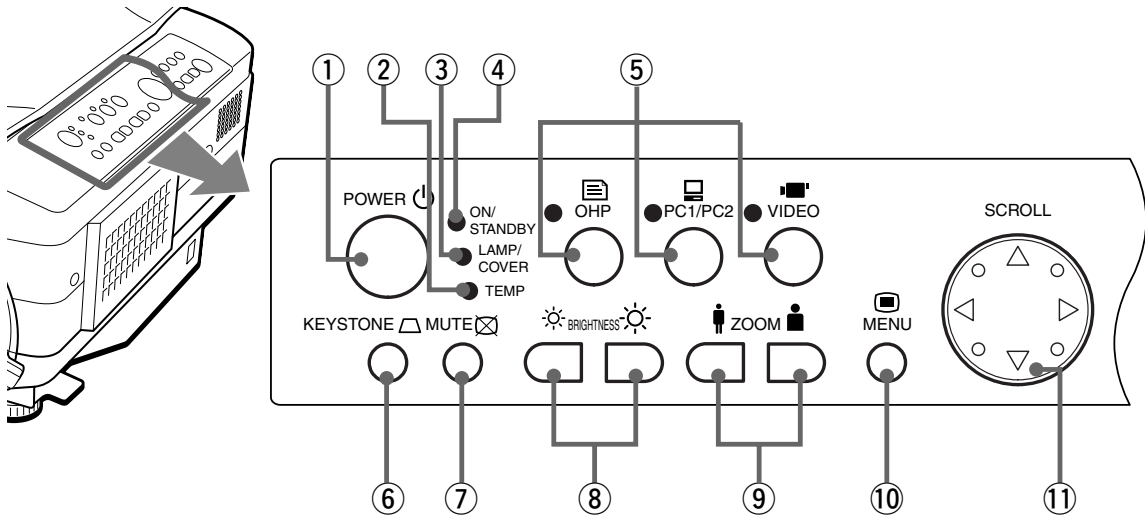

①	PC Video Input	Input terminal for the PC analog RGB signals. Two personal computers can be connected.
②	PC Audio Input	Audio input terminal for a PC (stereo compatible). Two personal computers can be connected.
③	RGB Video Output	When OHP is selected, OHP images are output. When PC/VIDEO input is selected, input PC video is output as it is. During standby, RGB-IN1 images that are input from the personal computer are output directly.
④	Test (maintenance)	This exclusive terminal is used when performing maintenance and in-house tests. It cannot be used for other connections.
⑤	Audio Output	Audio output terminal for MP-50E This terminal outputs audio (either from the PC or video source) that is currently being input. In the standby mode, PC audio is output. When OHP input is selected, PC audio is output.
⑥	S-VIDEO Input	Input terminal for video source (Y/C)
⑦	Video Source Video Input	Input terminal for video source (NTSC/PAL/SECAM)
⑧	Video Source Audio Input	Audio input terminals for a video source (stereo compatible)

## ■ Buttons and Indicator Lights



	Name	Description	Page to see
①	POWER Button	<ul style="list-style-type: none"> <li>Press this button to turn the lamp on or off.</li> <li>Only this button can be used when the lamp is off.</li> </ul>	E-20, 29, 41
②	TEMP LED	<ul style="list-style-type: none"> <li>This LED blinks for ten seconds and lights when the temperature inside the projector has built up.</li> </ul>	E-52
③	LAMP/COVER LED	<ul style="list-style-type: none"> <li>This LED lights while the lamp is on.</li> <li>When the lamp is turned on, it blinks for about six seconds then remains on.</li> <li>When the lamp is off, it blinks for about 60 seconds then remains off.</li> <li>This LED blinks when the lamp fails to light. (The LED blinking pattern in this case is longer than other instances.)</li> <li>Blinks when the lamp usage time exceeds 1400 hours, it remains on after lamp usage time exceeds 1500 hours.</li> <li>Lights when the air filter cover or the lamp unit cover is not in place.</li> </ul>	E-29 E-41 E-54 E-54, 56
④	ON/STANDBY LED	<ul style="list-style-type: none"> <li>This LED lights (red) in a standby state, and lights (green) when the lamp is on.</li> </ul>	E-29, 41
⑤	INPUT SELECT Buttons (OHP, PC1/PC2, VIDEO)	<ul style="list-style-type: none"> <li>Press this button to switch the input screen.</li> <li>When PC is selected, images from the PC input terminal are projected; when VIDEO is selected, images from the video source input terminal are projected; or, when OHP is selected, an image of the printed matter or document placed on the scanner on the main unit is projected.</li> <li>Pressing on the PC1/PC2 button when PC input is selected switches between PC input 1 and PC input 2.</li> </ul>	E-29
⑥	KEYSTONE Button	<ul style="list-style-type: none"> <li>Press this button to compensate keystone.</li> </ul>	E-21
⑦	MUTE Button	<ul style="list-style-type: none"> <li>Press to stop projecting the image without turning off the lamp. Press it again and the image will reappear.</li> </ul>	E-34, 40
⑧	BRIGHTNESS Buttons	<ul style="list-style-type: none"> <li>These buttons adjust the brightness. Pressing the  button darkens the projected image, and pressing the  button lightens the projected image.</li> </ul>	E-31, 37

**Part Names and Functions**





⑨	ZOOM Buttons	<ul style="list-style-type: none"><li>• These buttons adjust the zoom ratio. Pressing the  button reduces the image, and pressing the  button enlarges the image.</li></ul>	E-32, 38
⑩	MENU Button	<ul style="list-style-type: none"><li>• Display the menu display.</li></ul>	E-42
⑪	SCROLL Button	<ul style="list-style-type: none"><li>• Set and select the variable and adjustable values on the menu display.</li><li>• Move the zoom position when using the zoom display.</li><li>• Move the pointer when the pointer is displayed.</li></ul>	E-47 E-32, 38 E-34, 38

\* Once a menu or an adjustment is displayed, their display automatically disappears, and adjustment values are stored to memory if buttons are not operated for about 30 seconds.

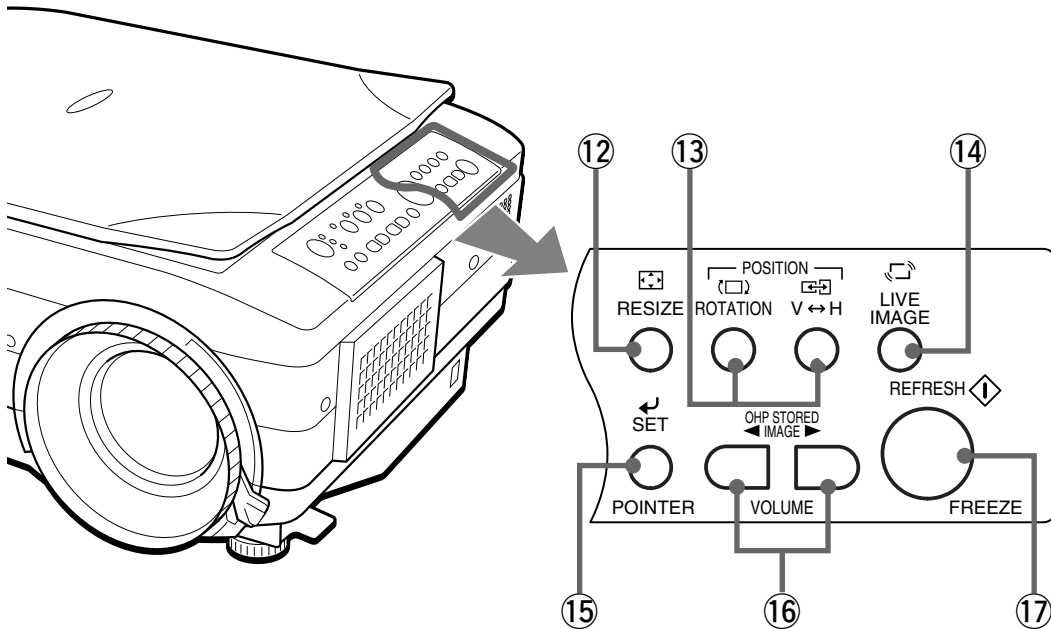
\* For details of menu adjustment, see page E-43 onwards.

## Buttons and Indicator Lights







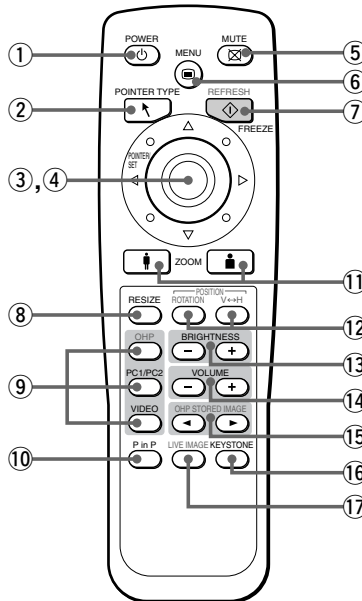



	Name	Description	Page to see
12	RESIZE Button	<ul style="list-style-type: none"> <li>Press to change the size of the projected image when OHP is selected.</li> <li>Press to do automatic synchronous adjustments when PC is selected.</li> </ul>	E-33 E-38
13	POSITION Buttons	<ul style="list-style-type: none"> <li>Press to change the orientation of the projected image when OHP is selected. Press the  button to reverse the top and bottom of the projected image. Press the  button to switch between vertical display and horizontal display.</li> </ul>	E-31
14	LIVE IMAGE Button	<ul style="list-style-type: none"> <li>Press to confirm the projected image while moving the document when OHP is selected.</li> </ul>	E-32
15	SET/POINTER Button	<ul style="list-style-type: none"> <li>Press this button to apply a menu item in the menu display.</li> <li>Display the pointer when the menu display is not displayed. Press it again to hide the pointer.</li> </ul>	E-48 E-34, 38
16	OHP STORED IMAGE/ VOLUME Buttons	<ul style="list-style-type: none"> <li>A maximum of eight pages of images are stored to internal memory when the display is refreshed, when OHP is selected. Press to access those images.</li> <li>Adjust the volume when PC or video is selected. Press the  button to reduce the volume. Press the  button to increase the volume.</li> </ul>	E-33 E-39
17	REFRESH/FREEZE Button	<ul style="list-style-type: none"> <li>Press to refresh the projected image when OHP is selected. Press it again to refresh the projected image if you have switched or moved the document.</li> <li>Press to freeze the projected image when PC or video is selected.</li> </ul>	E-32 E-39

# Remote Controller



	Name	Description	Page to see
①	POWER Button	<ul style="list-style-type: none"> <li>Press this button to turn the lamp on or off.</li> <li>Only this button can be used when the lamp is off.</li> </ul>	E-20,29,41
②	POINTER TYPE Button	<ul style="list-style-type: none"> <li>Press this button to select a pointer type.</li> </ul>	E-34,39
③	POINTER/SET Button	<ul style="list-style-type: none"> <li>Press this button to apply a menu item in the menu.</li> <li>Display the pointer when the menu is not displayed. Press it again to hide the pointer.</li> </ul>	E-48 E-34,38
④	SCROLL Button	<ul style="list-style-type: none"> <li>Set and select the variable and adjustable values on the menu display.</li> <li>Move the zoom position when using the zoom display.</li> <li>Move the pointer when the pointer is displayed.</li> </ul>	E-47 E-32,38 E-34,38
⑤	MUTE Button	<ul style="list-style-type: none"> <li>Press to stop projecting the image without turning off the lamp. Press it again and the image will reappear.</li> </ul>	E-34,40
⑥	MENU Button	<ul style="list-style-type: none"> <li>Press this button to display the menu display, or select menus.</li> </ul>	E-42
⑦	REFRESH/FREEZE Button	<ul style="list-style-type: none"> <li>Press to refresh the projected image when OHP is selected. Press it again to refresh the projected image if you have switched or moved the document.</li> <li>Press to freeze the projected image when PC or video is selected.</li> </ul>	E-32 E-39
⑧	RESIZE Button	<ul style="list-style-type: none"> <li>Press to change the size of the projected image when OHP is selected.</li> <li>Press to do automatic synchronous adjustments when PC is selected.</li> </ul>	E-33 E-38
⑨	INPUT SELECT Buttons (OHP, PC1/PC2, VIDEO)	<ul style="list-style-type: none"> <li>Press this button to switch the input screen.</li> <li>When PC is selected, images from the PC input terminal are projected; when VIDEO is selected, images from the video source input terminal are projected; or, when OHP is selected, an image of the printed matter or document placed on the scanner on the main unit is projected.</li> </ul>	E-29
⑩	P in P Button	<ul style="list-style-type: none"> <li>Press to display the image from the video source that is connected in a window on the lower right side of the projected image when PC selected.</li> </ul>	E-40

⑪	ZOOM Buttons	<ul style="list-style-type: none"> <li>These buttons adjust the zoom ratio. Pressing the  button reduces the image, and pressing the  button enlarges the image.</li> </ul>	E-32, 38
⑫	POSITION Buttons	<ul style="list-style-type: none"> <li>Press to change the orientation of the projected image when OHP is selected. Press the  button to reverse the top and bottom of the projected image. Press the  button to switch between vertical display and horizontal display.</li> </ul>	E-31
⑬	BRIGHTNESS Buttons	<ul style="list-style-type: none"> <li>These buttons adjust the brightness. Pressing the  button darkens the projected image, and pressing the  button lightens the projected image.</li> </ul>	E-31, 37
⑭	VOLUME Buttons	<ul style="list-style-type: none"> <li>Adjust the volume when PC or video is selected. Press the  button to reduce the volume. Press the  button to increase the volume.</li> </ul>	E-39
⑮	OHP STORED IMAGE Buttons	<ul style="list-style-type: none"> <li>A maximum of eight pages of images are stored to internal memory when the display is refreshed, when OHP is selected. Press to access those images.</li> </ul>	E-33
⑯	KEYSTONE Button	<ul style="list-style-type: none"> <li>Press this button to compensate keystone.</li> </ul>	E-21
⑰	LIVE IMAGE Button	<ul style="list-style-type: none"> <li>Press to confirm the projected image while moving the document when OHP is selected.</li> </ul>	E-32



## Remote Control Operations

- Use the remote control within about seven meters (7.7 yards) from the remote control sensors (on the front and rear sides) of the projector and within 10 degrees to the left and right. This distance may become shorter as the battery wears down.
- The remote controller does not work if there are obstacles between the remote control and the remote sensor on the main unit.

## Battery Replacement

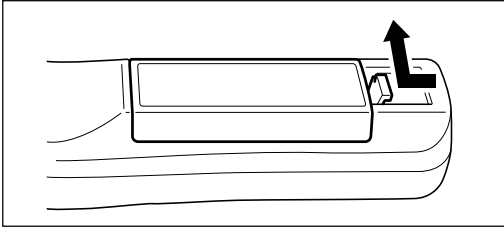

1. Remove the battery compartment cover by pushing in the claw and lifting the cover up.

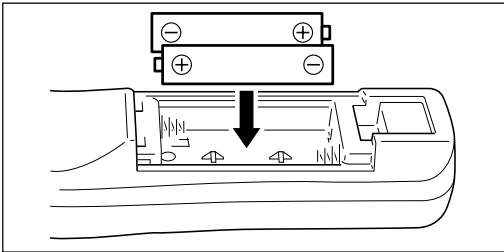

2. Install two batteries in the battery compartment, making sure that they are aligned as indicated by the (+) and (-) marks.

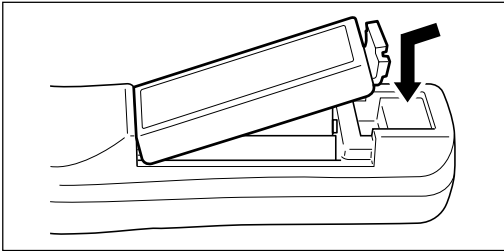

3. Return the battery compartment cover to its original position.

### CAUTION

#### Handling the remote controller

- Do not subject the remote controller to such severe impact as dropping it on the floor. Doing so may damage it and cause it to cease functioning.
- Keep the remote sensor away from water. Wipe the remote controller immediately if it gets wet.
- Avoid heat or hot water. Remove the dry cells when you are not using the remote controller for a long period of time.
- Do not mix new and old dry cells, or use different types of dry cells at the same time.
- Do not disassemble or heat batteries, or throw them into a fire.
- Follow your local government's disposal instructions for used dry cells.
- The remote controller may not work when it is used near inverter-driven equipment.
- The remote controller may not work or may work ineffectively when it is used near inverter-driven fluorescent lighting.

### NOTE

- When replacing the batteries, buy AA batteries.
- Ni-Cad batteries or other chargeable batteries cannot be used. Use manganese batteries or alkaline batteries.

# How to Install the Projector

## Installation Sequence

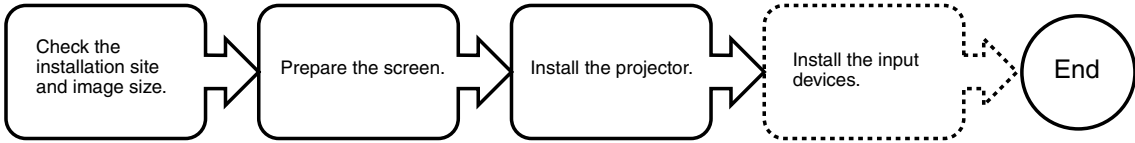

See "Projection Distance and Projected Image Size" on page E-19.

PC, video source, etc.

## Adjusting the Tilt

The position and tilt angle of the projected image can be adjusted by adjusting the adjustable feet. Press both the left and right tilt adjustment levers to lift the main unit, and release them when the desired height is reached. You can fine-adjust the tilt by turning the bottom section of the adjustable feet. Turning this section counterclockwise raises the main unit, and turning it clockwise lowers the main unit. Also, you can adjust the tilt angle by turning the adjustable foot located on the rear left of the main unit.

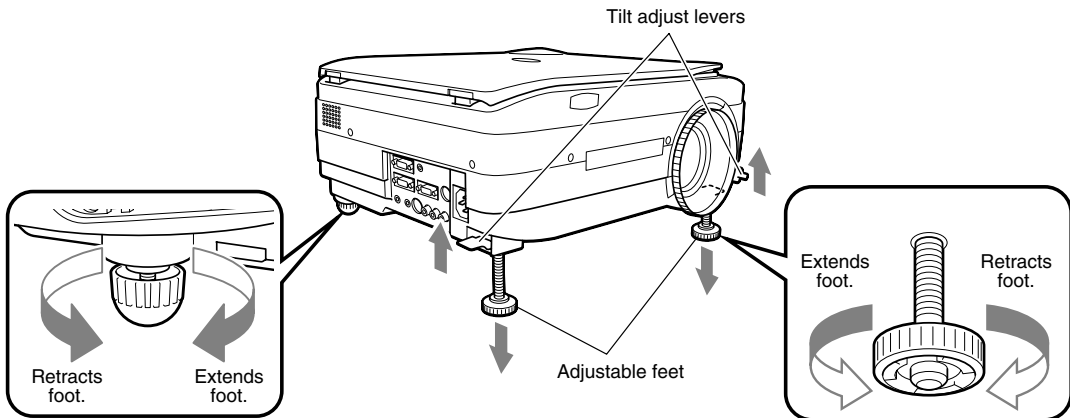

### **CAUTION**

- Do not tilt the main unit at extreme angles by turning only one side of the adjustable feet. Doing so may cause the main unit to slip or fall down, resulting in accidents or failures.
- Vent A on the bottom of the main unit takes in air to cool the inside of the projector. As air is taken in by large suction force, cloth or paper may be sucked in against the vent. If this happens, the temperature inside may build up, and cause an accident or failure.
- The rubber feet may soil the installation surface depending on where the projector is installed.

## ■ Projection Distance and Projected Image Size

Use the following diagrams to determine the projected image size and the type of screen required for any given projector location.

- The projection distance that provides good focusing is 1.4 m (1.5 yd) to 13.9 m (15.2 yd) from the front of the lens. Install the projector within this range.

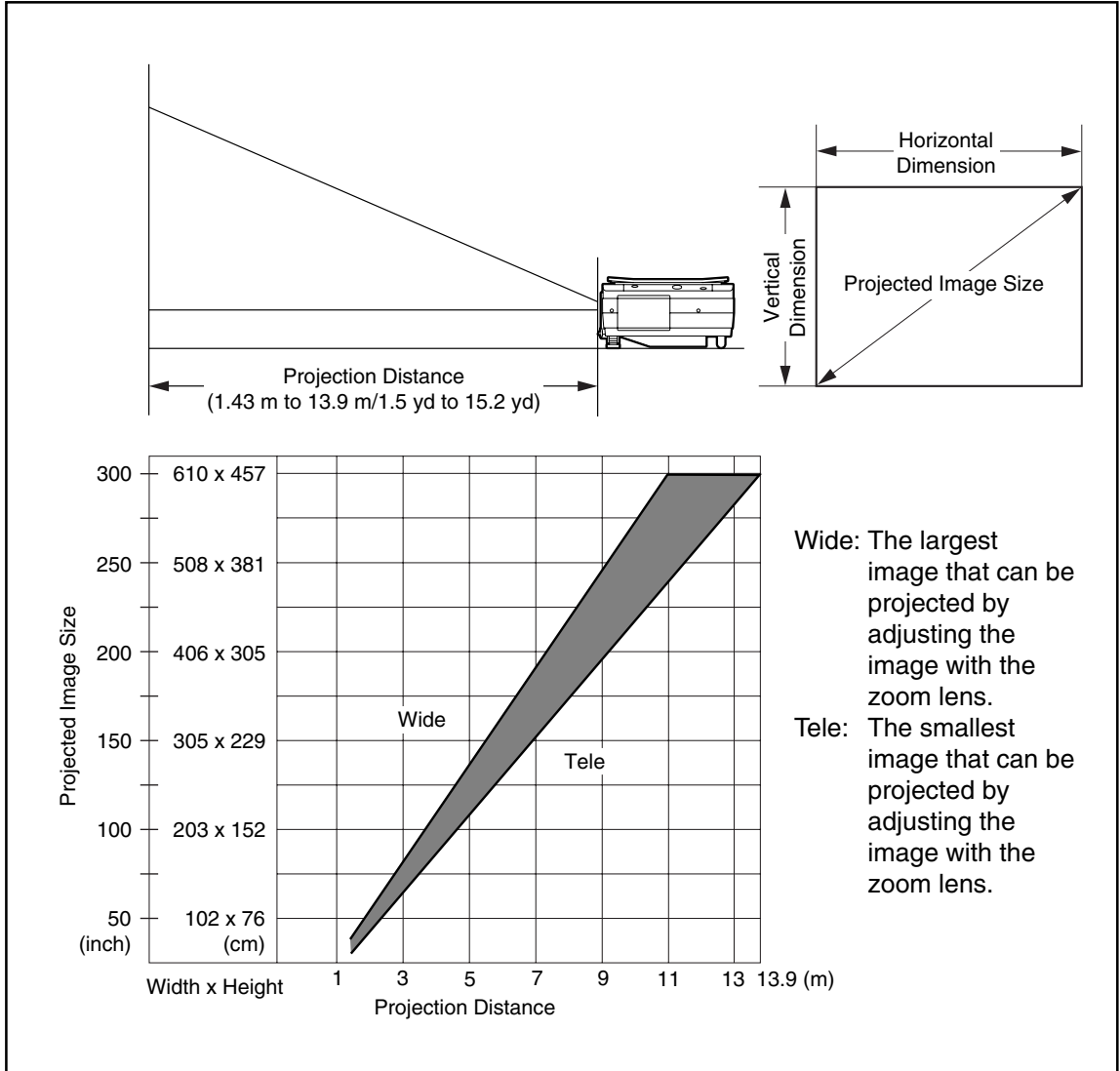

### ⚠ CAUTION

#### Installation location

- Do not install the projector in excessively hot or cold locations. The ambient temperature should be within 0°C to 35°C (32°F to 95°F).
- Position the projector so that the screen does not directly receive sunlight or other light from other lighting. Otherwise, the projected image becomes white and is difficult to view. In a bright room, use a curtain or other means to darken the area around the screen.
- Do not install the projector where it will be subject to excessive humidity, dust, or cigarette smoke. Otherwise, image quality may deteriorate as dirt builds up on the lens, mirrors and other optical components.
- Do not install the projector in a small room with poor air circulation or any place where the air vents may be blocked. Temperature build-up inside the projector may result in fire or a failure. (Vents are located on the bottom and right side of the projector.)

## ■ Typical Installation

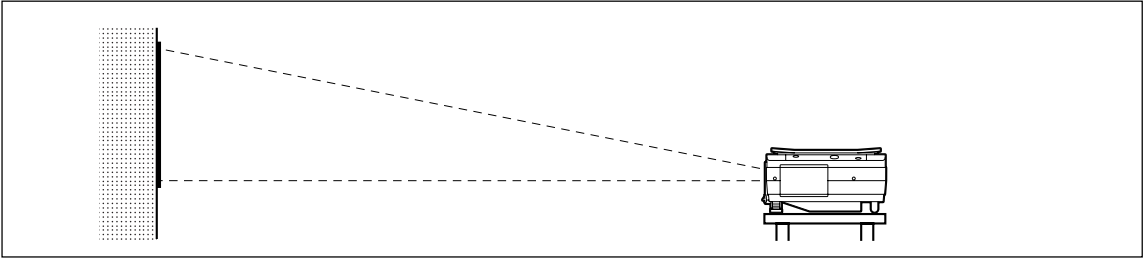

### 1. Select the installation site

Place the projector on an even and stable surface such as a table.

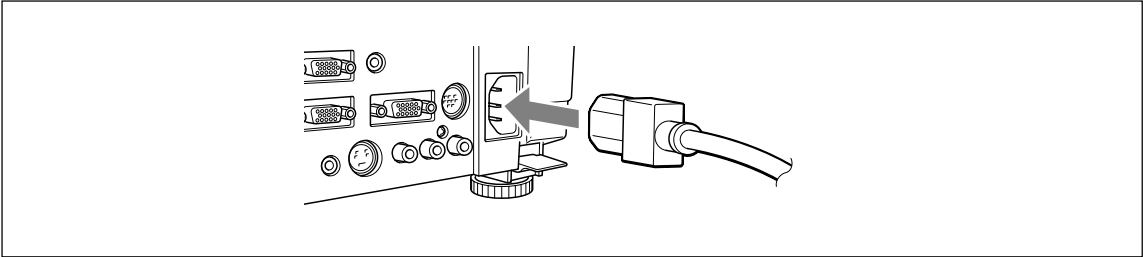

### 2. Connect the power cord (supplied), and press the button (or button.)

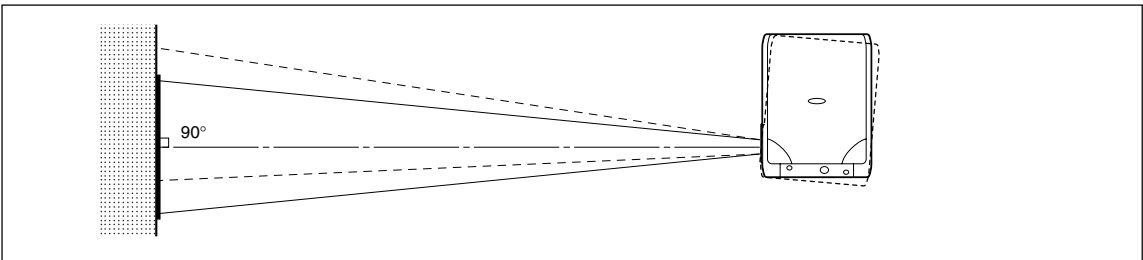

### 3. Turn the direction of the lens so that it is perpendicular to the screen.

Turn the unit to the left or right so that the top and bottom lines of the projected image are parallel.

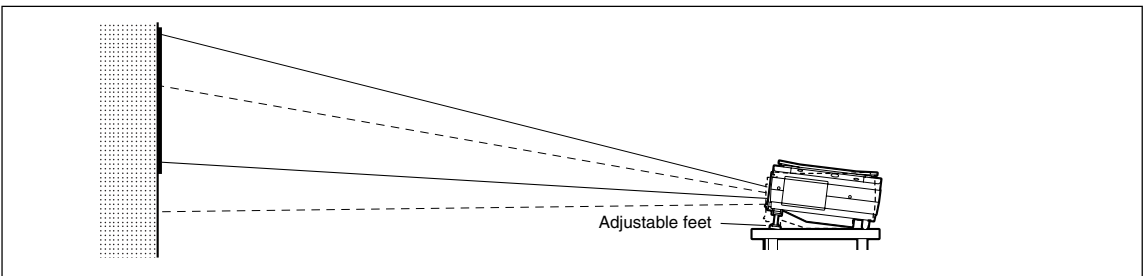



### 4. Adjust the adjustable feet to move the projected image to the desired height. (Adjust the tilt angle between 0° to 7°.)

The position of the projected image can be moved up or down by adjusting tilt.

## ■ Compensating Keystone

If the projected image is distorted, you can eliminate the distortion by doing keystone compensation.

### ● How to Compensate Keystone

Press the  button (or the  button on the remote controller) to display the “Keystone menu.”

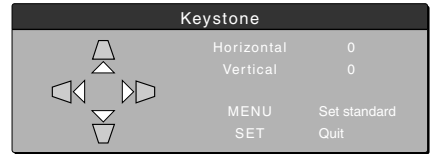

Keystone menu

Press the  button to make the top of the projected image narrower.

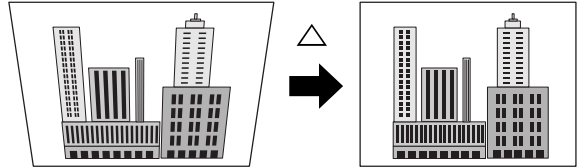

Press the  button to make the bottom of the projected image narrower.

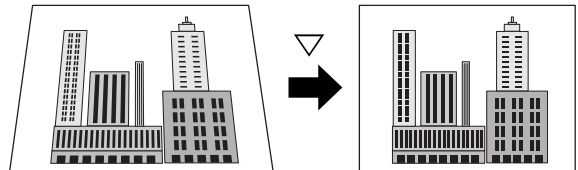

Press the  button to make the left side of the projected image narrower.

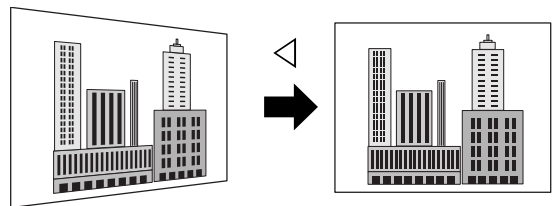

Press the  button to make the right side of the projected image narrower.

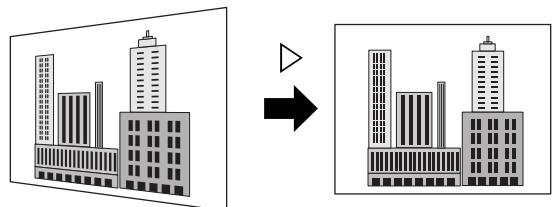

Press the  button (or the  button on the remote controller) to return to “0” (No compensation).

#### NOTE

- When keystone compensation is performed, the resolution at the edges of the projected image is reduced, making small characters difficult to read. To prevent this, place the projector on as level a surface as possible, and set the Keystone menu to “0” (No compensation).
- As image processing is performed for keystone compensation, displayed images (characters, etc.) are displayed slightly blurred when keystone compensation is used compared with when it is not used.
- When displaying an image with VGA resolution less than 640 x 480 pixels with a excessive horizontal keystone compensation may cause parts of the image to become fuzzy. See page E-25 for more information.
- The degree to which keystone compensation can be adjusted depends on the image signal.
- If the horizontal value is adjusted to its largest (or smallest) the vertical adjustment value can not be moved in the plus direction when doing keystone compensation.

# Connecting to a Personal Computer

## CAUTION

### Cautions on Connection

- Before connecting other devices, turn off each device to protect the projector and other connected devices.
- For details of how to connect and use devices connected to the projector, refer to the User's Manual for each device.
- Sometimes images are not displayed on the screen properly when they are displayed on a notebook PC LCD as well. If this happens, turn the notebook PC display off to remedy this. The method for turning off a notebook PC display varies according to the notebook PC manufacturer. For details, refer to the User's Manual of the notebook PC.
- You may not be able to connect the projector depending on the model of personal computer and personal computer settings. Consult your dealer for details.

## ■ Connecting to a Personal Computer

### ● List of cables and adapters

Manufacturer	Type	RGB output	Connection
		Model	
PC/AT compatible machine	Notebook, desktop	15-pin Mini D-Sub (VGA)	Supplied cable
		Respective companies	
Apple Macintosh	Notebook	Power Book G3 (with Mini D-Sub 15-pin monitor output terminal)	Supplied cable
		Power Book (excluding iBook, DUO, 100, 140, 145B, 150, 170, etc.)	Adapter (third party)*+ adapter + supplied cable
		PowerBook DUO	Adapter (third party)*+ adapter + supplied cable
		* Models having no monitor output terminal such as iBook, Power Book 100, 140, 145B, 150, 170 cannot be connected.	* DUO Dock or Mini Dock is required.
	Desktop	G3, G4 (with Mini D-Sub 15-pin monitor output terminal)	Supplied cable
	Various models (excluding integrated monitor type)	Adapter + supplied cable	
	* Monitor integrated models such as iMac, Classic and some Performa models cannot be connected as they have no monitor output terminal.	* The separate display adapter (Apple) is required for the Power Mac 6100.	

\* Adapter (sold separately): Power Book exclusive adapter (Apple Power Book Video Adapter Cable M3927LL/A, or equivalent). It may be provided with the Power Book.

### About the PC Input and Output

The 15-pin mini D-Sub connectors are used for the PC input and output terminals. The following shows the relationship between the pins and the input and output signals.

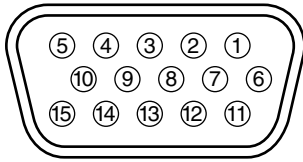

① RED VIDEO	⑥ GND	⑪ NC
② GREEN VIDEO	⑦ GND	⑫ Pull up (+5V)
③ BLUE VIDEO	⑧ GND	⑬ H.SYNC
④ GND	⑨ NC	⑭ V.SYNC
⑤ NC	⑩ GND	⑮ Pull up (+5V)

#### NOTE

- This projector uses a 15-pin RGB input and an analog type output terminals. For this reason, it cannot be connected to a digital output type personal computer.
- Plug and play is not supported.

## About RGB Video Output

### ● Signal timing

The following shows the timing that signals are output from the RGB video output terminal. (XGA 60Hz speed or equivalent)

The video signal output is determined by whether “PC/OHP” or “OHP” is selected in “RGB-OUT Selection” on the “Setting 2” menu. See page E-45 for more information.

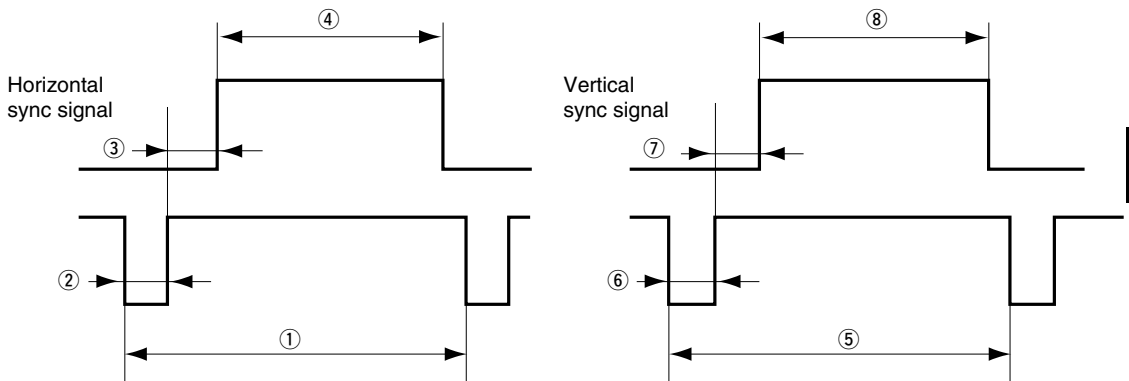

Horizontal sync signal	① Cycle	20.677 $\mu$ s
	② Sync signal width	2.092 $\mu$ s
	③ Back porch	2.462 $\mu$ s
	④ Display interval	15.754 $\mu$ s
Vertical sync signal	⑤ Cycle	806 H
	⑥ Sync signal width	6 H
	⑦ Back porch	29 H
	⑧ Display interval	768 H
Scan mode		Non-interlaced

#### NOTE

- The screen is sometimes not displayed normally depending on the monitor or projector that is connected.
- Images from a PC are output in standby.

## ■ When Images on the Personal Computer Screen are not Projected

Check the following when images on the personal computer screen are not projected or projected images are incorrect.

### ● When images are not projected

When external output signals are input to the MP-50E from the PC, “No signal” is displayed on the screen. When this is displayed, check the following.

#### 1 Try restarting the personal computer.



The MP-50E is sometimes not recognized by the PC if it is connected after the PC is started up. If this happens, images are not projected as external output signals are not output from the PC.

#### 2 Check the functions on the personal computer.

Some notebook PCs require a special operation to transmit the signals from the external output terminal. The external output signals may not be transmitted from the notebook PC unless the operation is performed. Refer to the manuals of your notebook PC for the information about how to output signals from the external output terminal.

Procedure example

- In the case of IBM PC/AT:

Press  key together with one of the keys, . This procedure may vary depending on the model.)

### ○ List of remedies when connection trouble with the PC occurs

Manufacturer	Series	External Output Switching Method
IBM	Think Pad	Fn+f7
COMPAQ	CONTURA ARMADA	Fn+f4
DELL	LATITUDE	Fn+f8

\* The above table summarizes conditions that have occurred to date; it is not a comprehensive summary of all connections.

\* Company names and product names listed in the above table are trademarks or registered trademarks of respective companies.

### ● Images are not projected correctly even though they are displayed normally on the notebook PC screen

#### 1 Verify the functions of the notebook PC.

Even if the LCD screen of a notebook PC displays normal images, the projected images may be displayed incorrectly. In most cases, because of the limitations of the notebook PC, the simultaneous display function (the external output signals are sent out simultaneously while the images are displayed on the PC screen) produces signals, which do not satisfy the standard specification and are outside the range supported by the projector. In this case, the incorrect display images can not be corrected even if the fine adjustments are made at the projector side. The correct images may be projected if only external output signals are provided without using the simultaneous display. Refer to the user's manual of your notebook PC for details.



## ■ Input Signal Compatibility Table (PC video input terminal)

The MP-50E supports the signals marked by ● in the following table. Note that on some PC models, flickering and blurring occur in the projected image. If this happens, adjust the projected image in the Sync Adjustment menu.

Signal Name	Resolution (Horizontal × Vertical)		Horizontal Frequency (kHz)	Vertical Frequency (Hz)	Compatibility
NTSC RGB	-	-	15.7	60	×
PAL/SECAM RGB	-	-	15.6	50	×
VGA-GR1	640	480	31.5	60	●
VGA-GR2*	640	400	31.5	70	●
VGA-GR3*	640	350	31.5	70	●
VGA-TX1*	720	400	31.5	70	●
VGA-TX2*	720	350	31.5	70	●
640×480 72Hz	640	480	37.8	72	●
640×480 75Hz	640	480	37.5	75	●
640×480 85Hz	640	480	43.2	85	●
Mac13"RGB	640	480	35.0	66	●
800×600 56Hz	800	600	35.1	56	●
800×600 60Hz	800	600	37.8	60	●
800×600 72Hz	800	600	48.0	72	●
800×600 75Hz	800	600	46.8	75	●
Mac16"RGB	832	624	49.7	74	●
1024×768 43Hz	1024	768	35.5	43	×
1024×768 60Hz	1024	768	48.3	60	●
1024×768 70Hz	1024	768	56.4	70	●
1024×768 75Hz	1024	768	60.0	75	●
1024×768 85Hz	1024	768	68.7	85	●
MAC19"1024×768	1024	768	60.2	75	●
MAC21"1152×864	1152	864	68.7	75	●
1280×960 60Hz	1280	960	60.0	60	●
1280×960 85Hz	1280	960	85.9	85	●
1280×1024 60Hz	1280	1024	64.0	60	●
1280×1024 75Hz	1280	1024	80.0	75	●
1280×1024 85Hz	1280	1024	91.1	85	●
1600×1200 60Hz	1600	1200	75.0	60	●
1600×1200 65Hz	1600	1200	81.3	65	×
1600×1200 70Hz	1600	1200	87.5	70	×
1600×1200 75Hz	1600	1200	93.8	75	×
1600×1200 85Hz	1600	1200	106.3	85	×

- When the input signal resolution is lower than 1024×768 dots, enlarge the display. When it is higher, compress the display.
- Signals marked with an \* may become fuzzy if too much vertical keystone compensation is applied. When using one of these signals, set the keystone compensation so that it does not distort the image.

## ● Basic connections

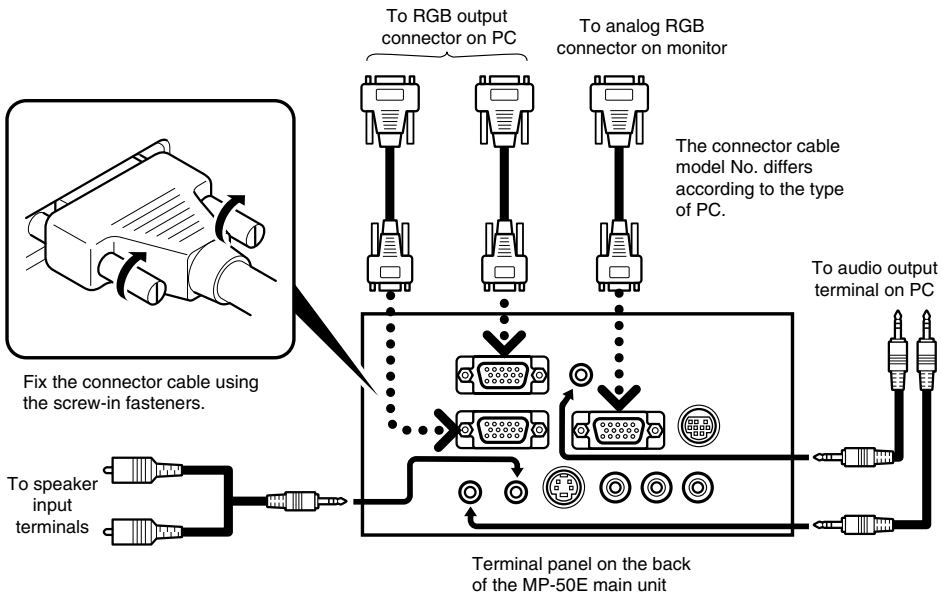

### NOTE

- The personal computer has input terminals for both image and sound for "1" and "2". Hook up the sound and image to the corresponding terminals. If they are not hooked up to the corresponding terminals, the image and sound will not be output correctly.
- See page E-11 for information about the input and output terminals.

## ● Connecting to IBM NOTE and Compatible

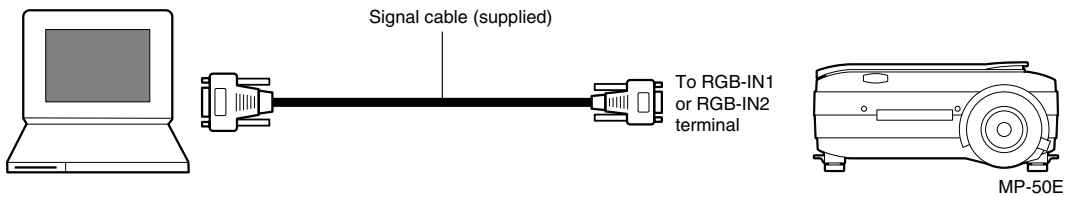

### NOTE

After you have connected the supplied cable, check the external CRT output/internal LCD output states and set the mode in the software running on the PC.  
The connection with the PC will not be made if you do not set the external CRT output mode.

### ● Connecting to an IBM Desktop and Compatible

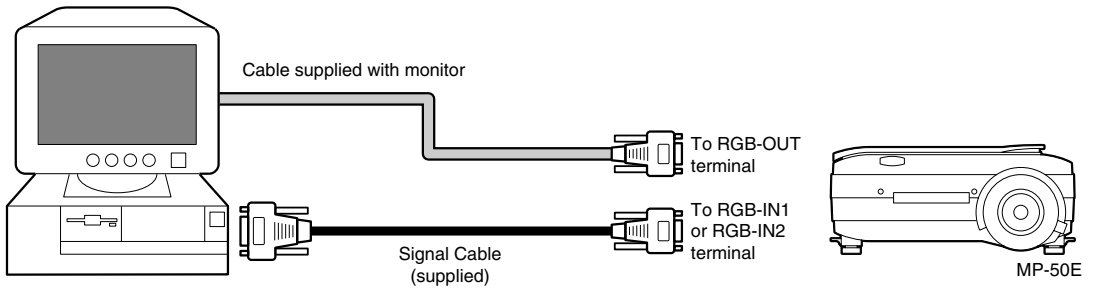

#### NOTE

When connecting the projector directly to the PC without using the monitor supplied with the PC, you can connect by the supplied cable only.

### ● Connecting to Apple Macintosh Notebook

Excluding Power Book Duo, 100, 140, 145B, 150, 170

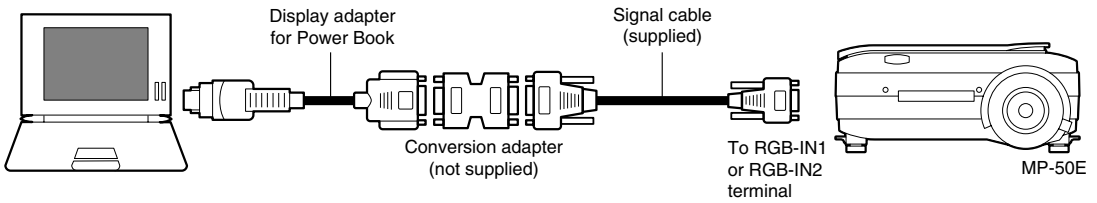

#### NOTE

- When connecting the Power Book Duo, the Duo Dock or Mini Dock is required.
- The Power Book display adapter is sometimes not supplied with the Power Book. If it is not supplied, buy a separate display adapter from a Macintosh computer store. (Apple M3927LL/A or equivalent)

## ■ Connecting to a Video Source or DVD Player

Images from a video source or DVD player can be projected on a large screen.

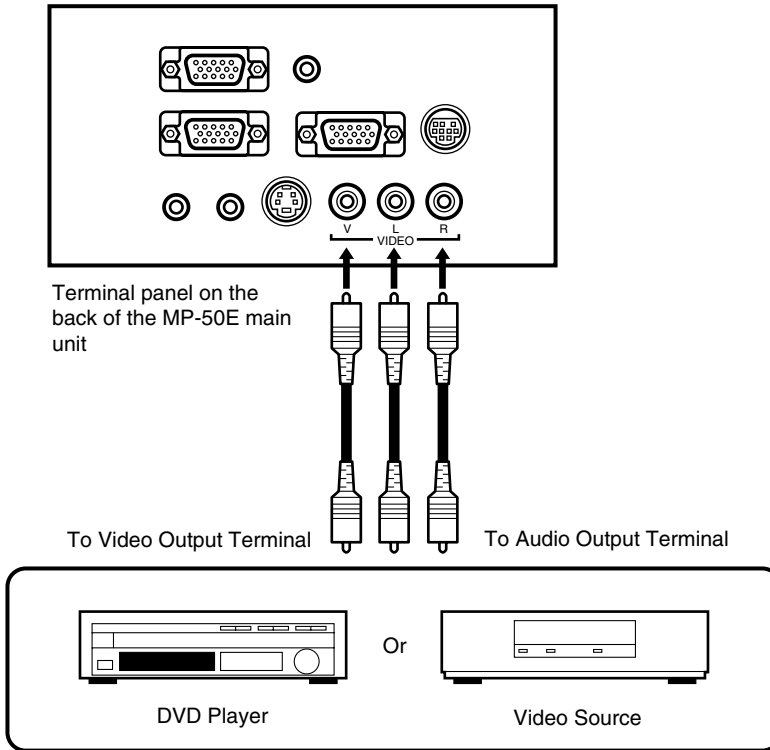

### NOTE

- When both VIDEO and S-VIDEO are connected, S-VIDEO is given higher display priority.
- Before using the video source or DVD player, close the materials cover. (Otherwise, the glass on the scanner may vibrate and cause a rattling sound.)

# Basic Operation

## ■ Preparation

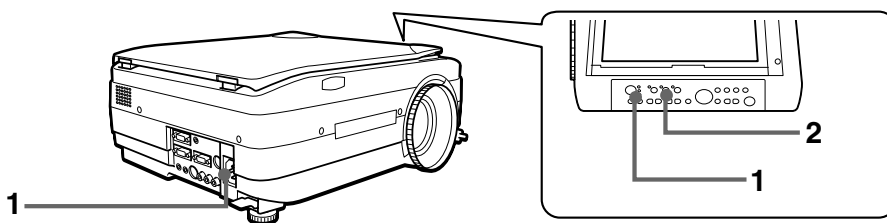

1

### Connect the power cord.

The projector is in the standby mode, and the power indicator LED lights (red).



Press the POWER button. The fan spins, the LED lights, and the ON/STANDBY LED lights (green).

The LAMP/COVER LED lights (green).

If the LAMP/COVER LED lights red after turning on the POWER button, then there is something wrong. (See page E-52 for details.)

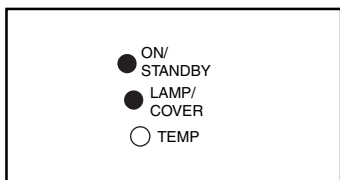

#### NOTE

Make sure that the lens cap has been removed before turning on the power.

2

### Main Unit Operation



### Remote Control Operation

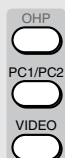

### Select the external input device.

Select the video source to be displayed from OHP, PC1/PC2, or VIDEO.



The selected input display is displayed.



See page E-30.

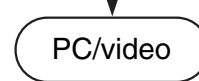

See page E-37.

#### NOTE

When PC/VIDEO is selected and the device is not connected, or the connected device is not turned on, "No input" is displayed.

## ■ Basic Operations in the OHP Mode

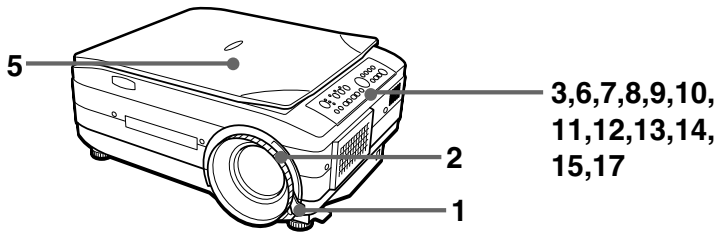

3,6,7,8,9,10,  
11,12,13,14,  
15,17

### NOTE

The projected image in the OHP display (projection of actual object) may be slightly distorted as a very wide-angle lens is used.

1

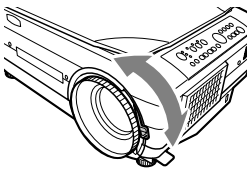

### Adjust the size of the projected image.

Rotate the zoom adjuster on the projection lens to adjust the size of the projected image.

2

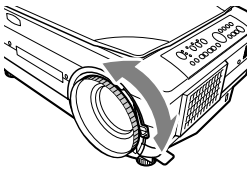

### Adjust the focus.

Adjust the focus adjuster on the projection lens until the projected image is sharp.

3

#### Main Unit Operation

KEYSTONE 



#### Remote Control Operation

KEYSTONE



### Compensate the keystone.

See "Compensating Keystone" on page E-21.

4

### Check the OHP's initial screen.

When you select OHP, the "Set your document and press the REFRESH button" message appears and the projected image becomes all white, and a window that shows how the document is moving appears on the bottom right of the projected image.

5

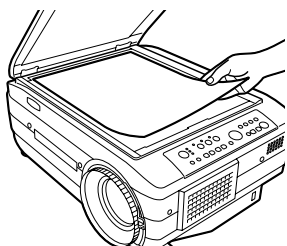
**Set the object you want to project.**

Open the materials cover, and place the document or printed matter you want to project on the scanner.

A video image of the projected material appears in the window.







Close the materials cover.

**NOTE**

*Objects can be projected even if the materials cover is not closed. However, unwanted objects will also be picked up, making the projected image difficult to view.*

6

**Main Unit Operation****Remote Control Operation****Adjust the brightness.**

Pressing the  button (or the  button on the remote controller) darkens the projected image, and pressing the  button (or the  button on the remote controller) lightens the projected image.

The "Brightness" value on the "Image Adjustment" menus changes in accordance with the brightness adjustment. See page E-43 for more information.

**NOTE**

*When projecting dark documents or printed matter, adjust to lighten the projected image, and when projecting bright documents or printed matter, adjust to darken the projected image.*

7

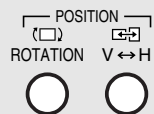
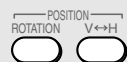
**Main Unit Operation****Remote Control Operation****Switch the orientation of the projected image.**

Orient the image in the direction of the document.

Press the POSITION button to switch the orientation of the projected image.

ROTATION button: Flip the projected image top to bottom.

V ↔ H button: Switch the image from a vertical to a horizontal display.

**8**

**Main Unit Operation**

REFRESH 



FREEZE

---

**Remote Control Operation**

REFRESH 



FREEZE

**Freeze the projected image.**

Press the REFRESH/FREEZE button to project a frozen image, of the material that you set in step five, on the white area of the projected image.

**9**

**Main Unit Operation**

 LIVE IMAGE



LIVE IMAGE

---

**Remote Control Operation**

LIVE IMAGE





LIVE IMAGE

**Close the window.**

Press the LIVE IMAGE button to close the window that is displayed, the entire projected image freezes.

**10**

**Main Unit Operation**



 ZOOM 



ZOOM

---





**Remote Control Operation**

 ZOOM 

ZOOM

**Adjust the zoom ratio.**

You can adjust the zoom between 1x to 6.25x.

Pressing the  button (or the  button on the remote controller) reduces the image, and pressing the  button (or the  button on the remote controller) enlarges the image.

**11**

**Main Unit Operation**

SCROLL

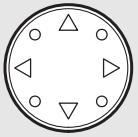

---

**Remote Control Operation**

SCROLL SET



SCROLL SET

**Move the zooming position.**

Press the arrow buttons on the remote controller to move the zooming position of the image. You can move in eight directions. (Up, down, left, right and diagonally).



12

**Main Unit Operation****Remote Control Operation****Project a full-screen image.**

When projecting a vertical image, press the RESIZE button to switch between a projected image that fills the screen from side to side or to one that fills the screen from top to bottom. (You can switch them even when adjusting the zoom.)

13

**Main Unit Operation****Remote Control Operation****Make the projected image live.**

There are the two following methods to move the document while checking the projected image.

- ① Make the window live.  
Set "Window" in "Movie mode" in the quick menu (page E-51). Pressing the LIVE IMAGE button displays live images in the window on the bottom right of the image.
- ② Make the entire image live.  
Set "Full" in "Movie mode" in the quick menu (page E-51). Pressing the LIVE IMAGE button displays live images on the entire projected image at about 1 frame per second. In this setting, the image doesn't change even if you press the LIVE button.

14

**Main Unit Operation****Remote Control Operation****View OHP STORED IMAGE.**

When you press the REFRESH button and the image freezes, a maximum of eight pages of the OHP images are stored on the internal MP-50E memory.

Press the OHP STORED IMAGE button to view and change the stored images on the internal memory. See page E-40 for details.

- ◀ button: Display the image previous to the currently displayed image from stored image.
- ▶ button: Display the image following the currently displayed image from stored image.

You can switch the stored images from the quick menu (page E-51) when viewing the OHP stored image.

**NOTE**

- Pressing the POWER button and going into standby erases the OHP stored images.
- The brightness can not be adjusted when viewing OHP stored image. Adjust the brightness before pressing the REFRESH/FREEZE button.

15

**Main Unit Operation****Remote Control Operation****NOTE**

Adjusting the zoom or the brightness while the pointer is displayed may cause it to disappear momentarily, but it will reappear after a short time.

**Display the pointer.**

Press the SET/POINTER button to display the pointer. Press it again to hide the pointer.

Press the SCROLL button to move the pointer.

16

**Remote Control Operation****Select the type of pointer.**

You can switch the type of pointer with the POINTER TYPE button on the remote controller. (Select from ↖, ●, or +.)

You can also select the type from “Pointer type” on the “Setting 2” menu. See page E-45 for details.

17

**Main Unit Operation****Remote Control Operation****NOTE**

After the projected image has been muted for a certain amount of time (about 15 minutes) it automatically goes into standby.

**Mute the image.**

Press the MUTE button to stop projecting the image without turning off the lamp. You can select the image projected while the image is muted from the following two images.

① Project a completely black image while the projected image is muted.

Set “Black” in “Mute mode” on the “Setting 2” menu (page E-45). While the image is muted, the projecting black image  icon is displayed on the top right side of the projected image.

② Project an arbitrary image while the projected image is muted.

Set “logo” in “Mute mode” on the “Setting 2” menu (page E-45).

While the image is muted, the projecting image  icon is displayed on the top right side of the screen.

## Document Orientation and Scan Size

Place the document or printed matter face down at the orientation shown in the figure below.

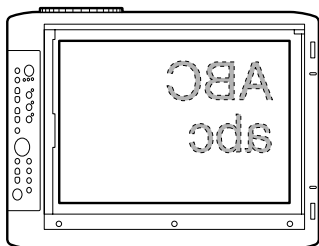

The maximum size that documents or printed matter can be scanned is 216 mm/8.5 in (vertical) and 288 mm/11.3 in (horizontal). For this reason, the projected sizes are as follows when an A4-size sheet of paper is placed at the respective orientations. (Shaded section is the projected area.)

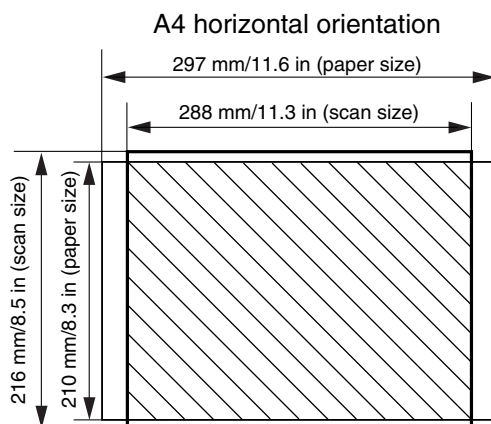

Parts protruding outside the scan area are not projected on the screen. To project these parts, move the paper.

## Displaying Live image in the window

While it is possible to display Live images in the window, the Live image is low resolution and is displayed against a background of a high definition frozen image on the main part of the projected image.

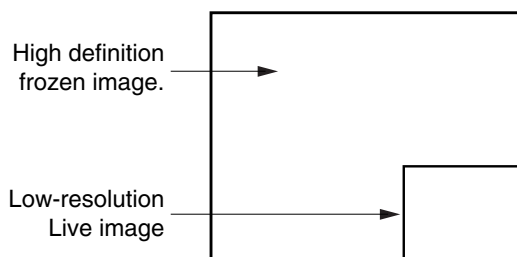



When the window is displayed, the “BRIGHTNESS,” “V ↔ H,” and “ROTATION” buttons are enabled for the window, but the ZOOM buttons are enabled for the main part of the projected image. (When you press the ZOOM buttons, the window disappears momentarily, but is displayed again after a short time.)

## Displaying OHP stored image

Pressing the  buttons display and switch the stored images in the internal memory.

 button: Displays the image previous to the stored image that is currently displayed.

 button: Displays the image following the stored image that is currently displayed.

\* Pressing the  button while a stored image is not displayed causes the most recently refreshed image that was stored to be displayed.

When you press the REFRESH button and the image freezes, a maximum of eight pages of the OHP images are stored on the internal MP-50E memory.

Press the POWER button, then after selecting OHP mode, the image of the first frozen image is stored to position ① in the diagram below. After that, every time you refresh the display the images are stored in the internal memory. When the stored images exceed the maximum of eight images the oldest images are overwritten in the order shown in the diagram below (starting from ①).

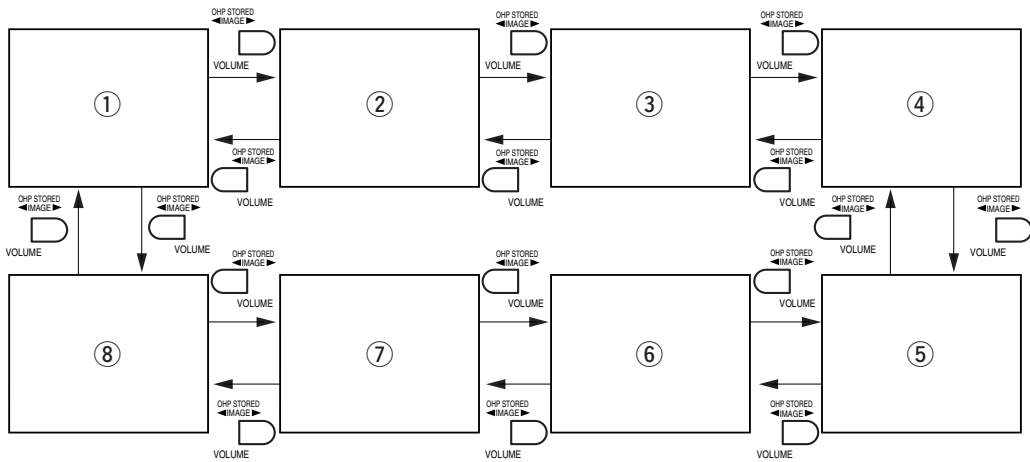

## Basic Operation of PC or Video Input

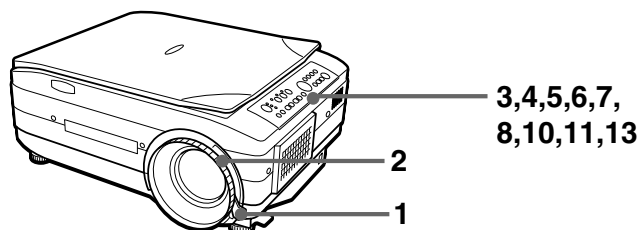

1

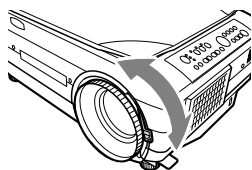

### Adjust the size of the projected image.

Rotate the zoom adjuster on the projection lens to adjust the size of the projected image.

2

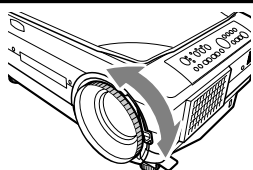

### Adjust the focus.

Adjust the focus adjuster on the projection lens until the projected image is sharp.

3

#### Main Unit Operation

KEYSTONE



#### Remote Control Operation

KEYSTONE



### Compensate keystone.

See “Compensating Keystone” on page E-21.

4

#### Main Unit Operation

BRIGHTNESS



#### Remote Control Operation

BRIGHTNESS



### Adjust the brightness.

Pressing the button (or the button on the remote controller) darkens the projected image, and pressing the button (or the button on the remote controller) lightens the projected image.

The “Brightness” value on the “Image Adjustment” menus changes in accordance with the brightness adjustment. See page E-47 for more information.

5

Main Unit Operation





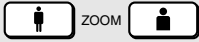

Remote Control Operation



**Adjust the zoom ratio.**

You can adjust the zoom between 1x to 4x.

Pressing the  button (or the  button on the remote controller) reduces the image, and pressing the  button (or the  button on the remote controller) enlarges the image.

6

Main Unit Operation

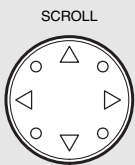

Remote Control Operation



**Move the zooming position.**

Press the arrow buttons on the remote controller to move the zooming position of the image. You can move in eight directions. (Up, down, left, right and diagonally).

7

Main Unit Operation



Remote Control Operation



**Synchronized Adjustments**

Press the RESIZE button to do automatic synchronous adjustments of each setting to the most suitable status on the "Sync Adjust" menu (Page E-44).

8

Main Unit Operation



Remote Control Operation



**Display the pointer.**

Press the SET/POINTER button to display the pointer. Press it again to hide the pointer.

Press the SCROLL button to move the pointer.



**NOTE**

*Adjusting the zoom or the brightness while the pointer is displayed may cause it to disappear momentarily, but it will reappear after a short time.*

9

## Remote Control Operation

**Select the type of pointer.**

You can switch the type of pointer with the POINTER TYPE button on the remote controller. (Select from , , or )

You can also select the type from “Pointer type” on the “Setting 2” menu. See page E-45 for details.

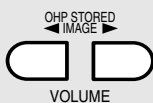

10

## Main Unit Operation



## Remote Control Operation

**Adjust the volume.**

Press the  button to reduce the volume.  
Press the  button to increase the volume.

11

## Main Unit Operation

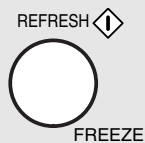

## Remote Control Operation

**Freeze the projected image.**

Press the FREEZE button to freeze the image from the personal computer or video.  
To unfreeze the image, press the FREEZE button again, or press the LIVE button.

**NOTE**

- You can not adjust the brightness when the image is frozen. Adjust the brightness before pressing the FREEZE button.
- Press the INPUT SELECT button to unfreeze the image when it is frozen.

12

**Remote Control Operation****Display images from the personal computer and the video at the same time.**

If you select personal computer input while a video source and a personal computer are both connected, you can display video images in the window at the lower right side of the projected image. Set "Picture in Picture" to "ON" on the quick menu to display video images. See page E-51 for details.

**NOTE**

- The P in P button is only enabled when a personal computer is selected. You can not use it when video is selected.
- You can not use the picture in picture function if the signal from the personal computer is not being input.

13

**Main Unit Operation**

MUTE

**Remote Control Operation****Mute the image.**

Press the MUTE button to stop projecting the image without turning off the lamp. You can select the image projected while the image is muted from the following two images.

- ① Project a completely black image while the projected image is muted.  
Set "Black" in "Mute mode" on the "Setting 2" menu (page E-45). While the image is muted, the projecting black image icon is displayed on the top right side of the projected image.
- ② Project an arbitrary image while the projected image is muted.  
Set "logo" in "Mute mode" on the "Setting 2" menu (page E-45).  
While the image is muted, the projecting image icon is displayed on the top right side of the projected image.

**NOTE**

After the projected image has been muted for a certain amount of time (about 15 minutes) it automatically goes into standby.



## ■ How to Quit

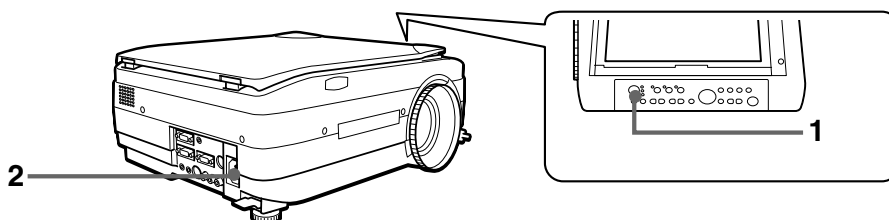

1

### Main Unit Operation

POWER 

### Remote Control Operation

POWER



### NOTE

The lamp will not turn on even if you press the POWER button if the LAMP/COVER LED is blinking green. To turn the lamp on again, press the POWER button again after the ON/STANDBY LED lights red.

### Turn the lamp off.

Press the POWER button. (Hold down for at least one second.)



“Press POWER button again to turn off.” is displayed on the projected image.



Press the POWER button again.

The LAMP/COVER LED blinks green, and then goes out after about one minute.

The ON/STANDBY LED lights (red.)

2

### Disconnect the power cord.

The ON/STANDBY LED on the operation panel goes out.

- ON/  
STANDBY
- LAMP/  
COVER
- TEMP

### CAUTION

- Do not disconnect the power cord before the lamp goes off or the LAMP/COVER LED lights. Doing so may shorten the life of the lamp.
- Disconnect the power cord from the power outlet if you are not going to use the projector for a long period of time.
- After disconnecting the power cord from the power outlet, wait a certain period of time (about 10 seconds) before connecting it again.



# ■ Performing Various Adjustments

## Menu Structure

You can perform various adjustments and make various settings by operating the buttons with the menu display displayed on the projected image.

There are two menus, the “Quick menu” on which there are frequently used items, and the “Main menu” on which more detailed settings can be done.

When a personal computer or video is connected and the power is on, you can open the “Quick menu” by pressing the  button (or the  button on the remote controller.) (See Page E-51 for information about the Quick menu.)

Press the  button (or the  button on the remote controller) again and the Main menu opens. You can go to the Adjust Settings menu from the Main menu display. A map of the menu displays is shown below.

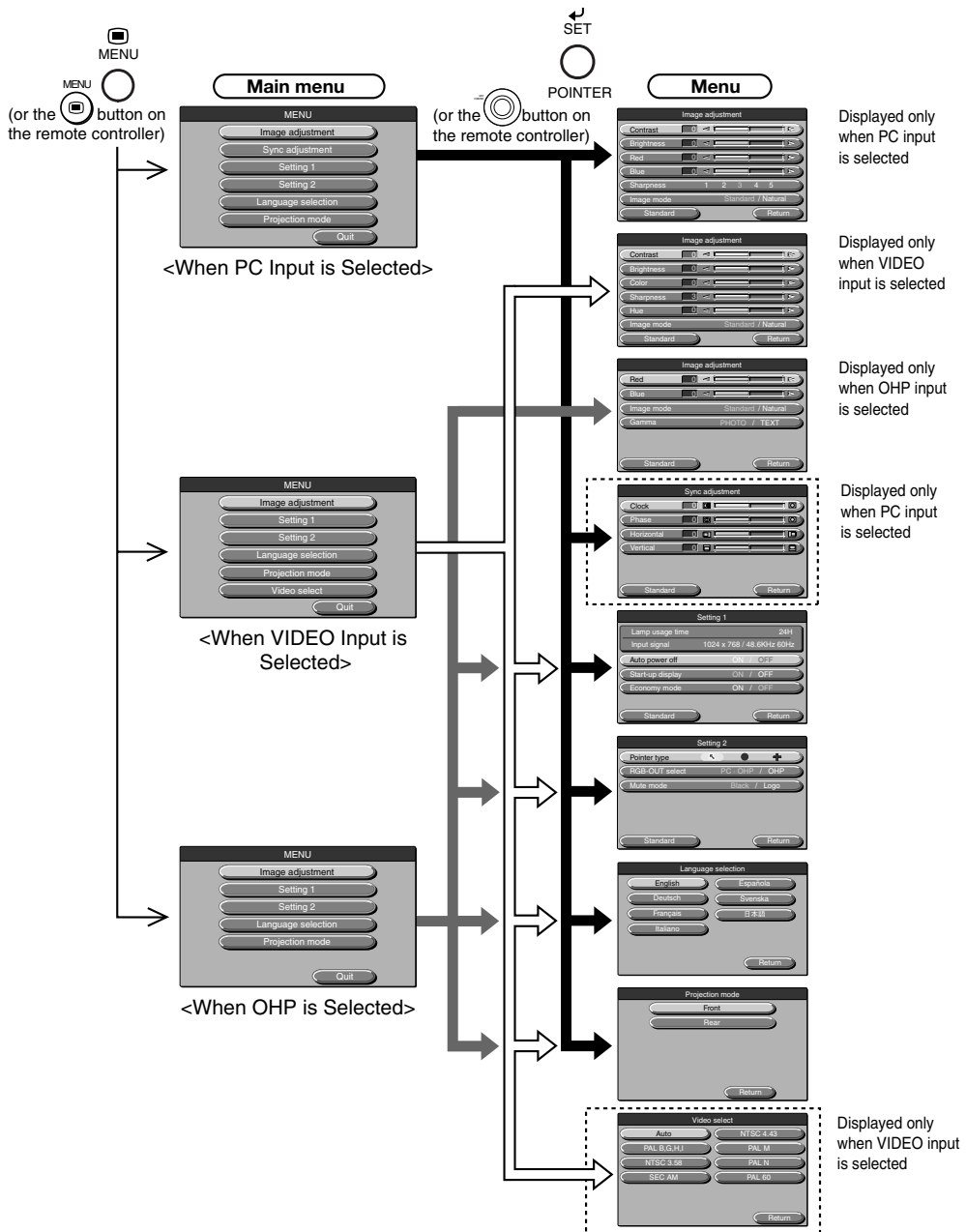

## Description of Menu Items

The following describes each of the menu displays, and the items and functions that can be set in these menu displays. For details of how to set these menu items, see “Basic Operation” on page E-47.

### ◆ Image Adjustment (when PC input is selected)



<Image Adjustment Menu>

Menu Item	Setting Item	Description
Contrast	-100 ~ +100	Adjusts the contrast of the projected image.
Brightness	-100 ~ +100	Adjusts the brightness of the projected image.
Red	-100 ~ +100	Adjusts the depth of the color red.
Blue	-100 ~ +100	Adjusts the depth of the color blue.
Sharpness*	1 ~ 5	Adjusts image sharpness. The higher the number goes the more clear the image becomes. The standard is “3.”
Image mode	Standard/ Natural	If you want to display an image that has high contrast and sharpness select “Standard”; if you want to reproduce colors that are close to the original select “Natural.”

\* Sharpness is especially effective when the images are enlarged and zoomed or if keystone compensation has been done.

### ◆ Image Adjustment (when VIDEO input is selected)



<Image Adjustment Menu>

Menu Item	Setting Item	Description
Contrast	-100 ~ +100	Adjusts the contrast of the projected image.
Brightness	-100 ~ +100	Adjusts the brightness of the projected image.
Color	-100 ~ +100	Adjusts the color of projected images.
Sharpness	0 ~ 6	Adjusts image sharpness.
Hue	-100 ~ +100	Adjusts the hue of projected images.
Image mode	Standard/ Natural	If you want to display an image that has high contrast and sharpness select “Standard”; if you want to reproduce colors that are close to the original select “Natural.”

◆ Image Adjustment (when OHP is selected)

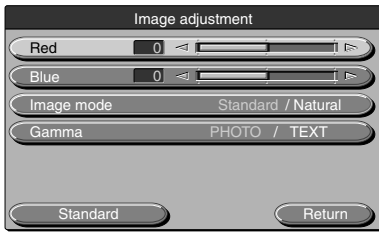

<Image Adjustment Menu>

Menu Item	Setting Item	Description
Red	-100 ~ +100	Adjusts the depth of the color red.
Blue	-100 ~ +100	Adjusts the depth of the color blue.
Image mode	Standard/ Natural	If you want to display an image that has high contrast and sharpness select "Standard"; if you want to reproduce colors that are close to the original select "Natural."
Gamma	PHOTO/ TEXT	The TEXT setting compensates for text documents, and the PHOTO setting compensates for photo documents.  Select the setting to suit the document you are projecting.

◆ Sync Adjustment (only when PC input is selected)

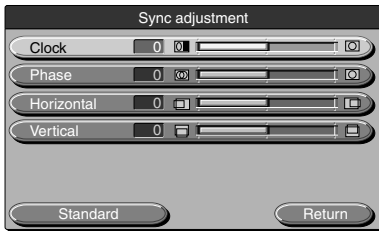

<Sync Adjustment Menu>

Menu Item	Setting Item	Description
Clock	-100 ~ +100	Adjusts the horizontal size of the image.
Phase	-100 ~ +100	Adjusts noise and flickering.
Horizontal	-100 ~ +100	Adjusts the horizontal position of the image.
Vertical	-100 ~ +100	Adjusts the vertical position of the image.

**NOTE**

*Menu items sometimes cannot be adjusted within the range -100 to +100 depending on the PC input signal.*

## ◆ Setting 1

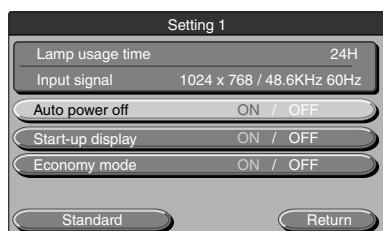

&lt;Setting 1 Menu&gt;

Menu Item	Setting Item	Description
Auto power off	ON/OFF	Sets the auto power off function ON/OFF. When auto power off is set to ON, the projector automatically goes to standby mode if no signals are input for a fixed period of time (about 15 minutes).
Start-up display	ON/OFF	Sets whether or not to display the Logo while the lamp is on.
Economy mode	ON/OFF	Sets the lamp in Economy mode.

**NOTE**

In the "Setting 1" menu, the currently set input signals and lamp usage time can be displayed for confirmation.

## ◆ Setting 2

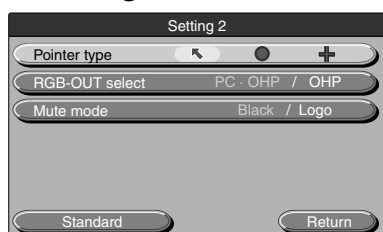

&lt;Setting 2 Menu&gt;

Menu Item	Setting Item	Description
Pointer type	↖●/+	Selects a type of pointer from among the three types.
RGB-OUT select	PC-OHP/OHP	When PC-OHP is selected: If the input selection is OHP, then the image is output as an OHP image for which the timing is changed to (XGA 60Hz) on page E-23. If the input selection is personal computer/video, then the personal computer image is a straight through output. When OHP is selected: No matter what input selection is made, OHP images are output at (XGA 60Hz) timing on page E-24.
Mute mode	Black/Logo	Sets the image to be displayed when the projected image is muted. When black is selected: The entire projected image appears black. When Logo is selected: Logo is displayed.

## ◆ Language Selection



<Language Selection Menu>

Menu Item	Setting Item	Description
Language selection	English	Sets the language used in display.
	Deutsch	
	Français	
	Italiano	
	Española	
	Svenska	
	日本語	

## ◆ Projection Mode

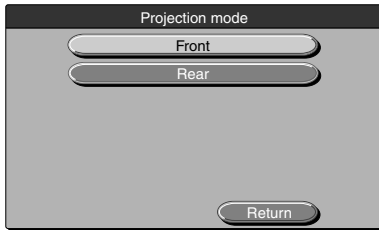

<Projection Mode Menu>

Menu Item	Setting Item	Description
Projection mode	Front	Adjusts the projection mode according to the installation method (front (standard) projection or rear projection).
	Rear	

## ◆ Video Select (only when video source input is selected)





<Video Select Menu>

Menu Item	Setting Item	Description
Video select	AUTO	Selects the input signal type.
	PAL B,G,H,I	
	NTSC 3.58	
	SECAM	
	NTSC 4.43	
	PAL M	
	PAL N	
	PAL 60	

## Basic Operation

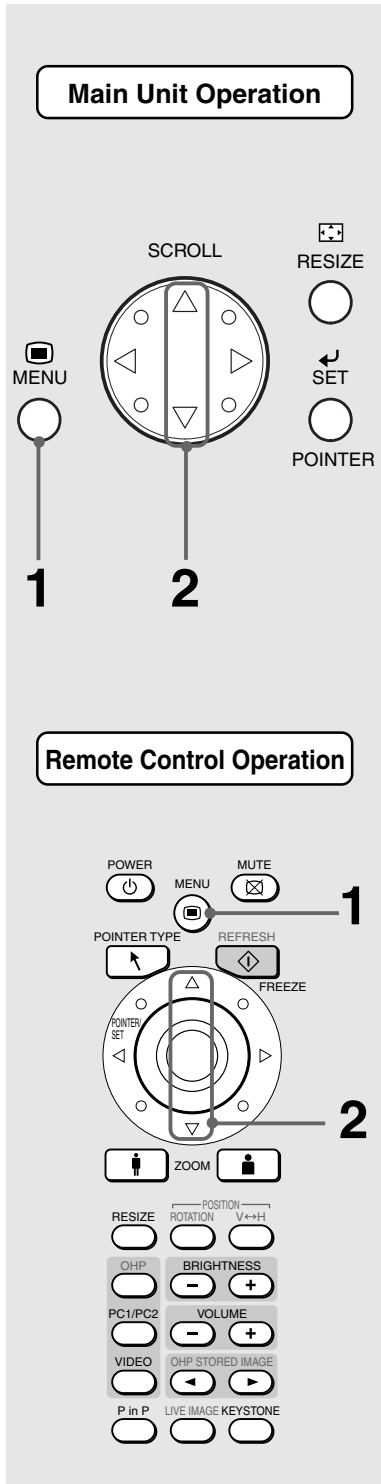
The following describes basic operations in the following menus: “Image Adjustment”, “Sync Adjustment”, “Setting”, “Language Selection”, “Video Adjustment”, and “Projection Mode”.



- 1** Press the  button (or the  button on the remote controller).

The main menu is displayed.

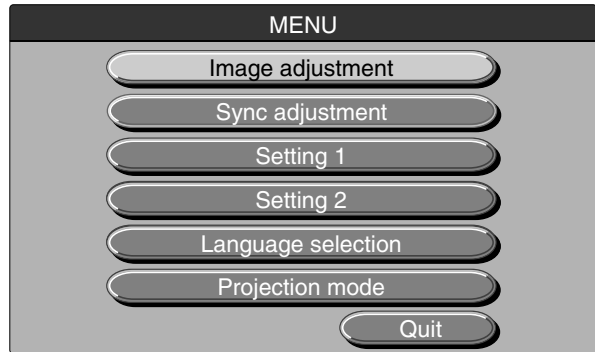

<Example: When PC input is selected>

- 2** Press the  /  buttons to select the item you want to set.

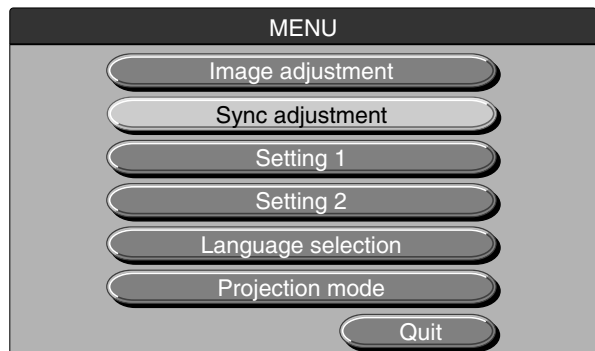

<Example: When “Sync adjustment” is selected>

## Main Unit Operation

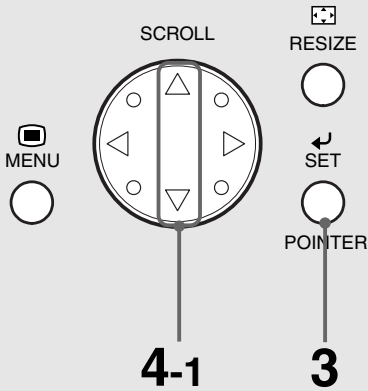

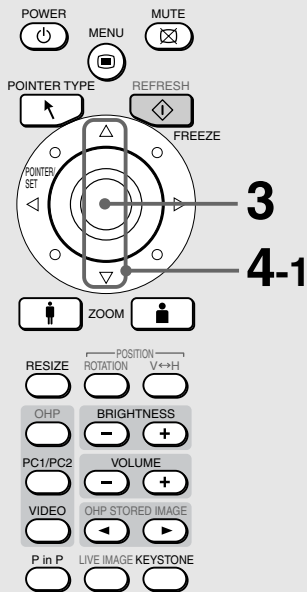

## Remote Control Operation



### 3 Press the button (or the button on the remote controller).

The menu for the item you want to set is displayed.

To return to the initial settings when you bought the projector, select “Standard” and press the  button (or  button) in the “Image adjustment”, “Sync adjustment”, “Setting” or “Video adjustment” menus.

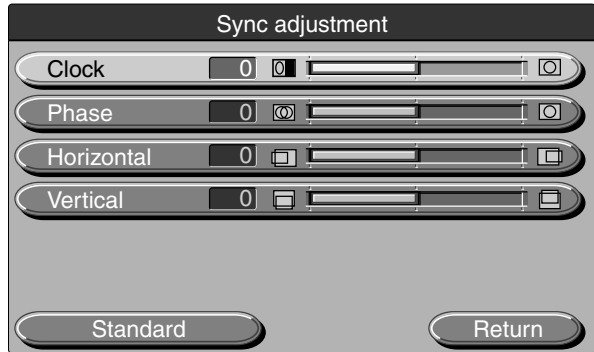

<Example: Sync Adjustment Menu>

### When selecting “ON” or “OFF”.

Menu items that require selection of “ON” or “OFF” are “Auto power off”, “Start up display”, and “Economy mode”. For details of these menu items, see page E-45.

### 4-1 Press the / buttons to select the item you want to set.

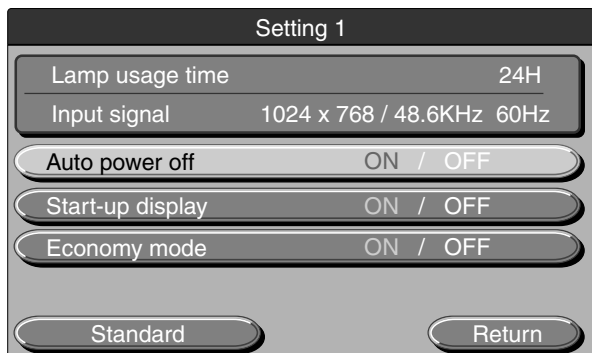

<Example: When “Auto power off” is selected>



Main Unit Operation

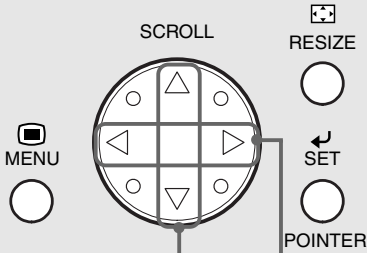

4-1 4-2

Remote Control Operation

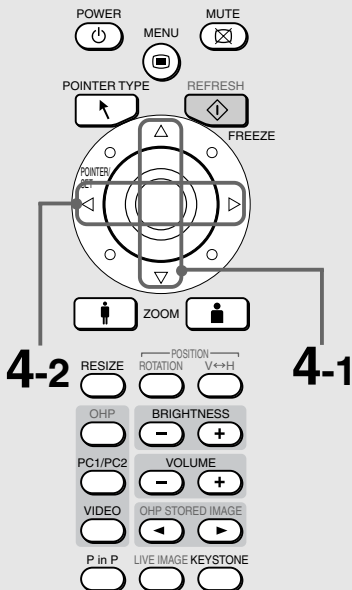

**4-2** Press the ◀/▶ buttons to select “ON” or “OFF”.

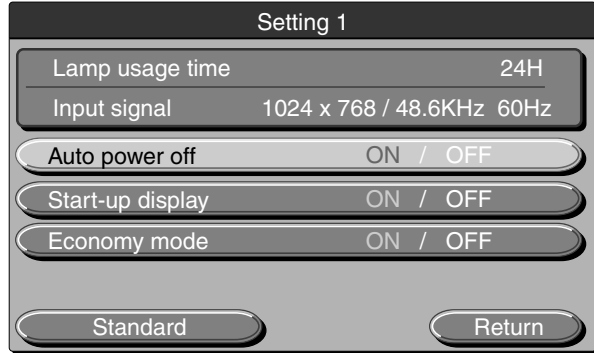

**When adjusting in single point units**

Menu items that require adjustment in single point units are “Contrast”, “Red”, “Blue”, “Clock”, “Phase”, “Horizontal”, “Vertical”, “Hue”, “Color”, and “Sharpness”. For details of these menu items, see page E-43.

**4-1** Press the ▲/▼ buttons to select the item you want to set.

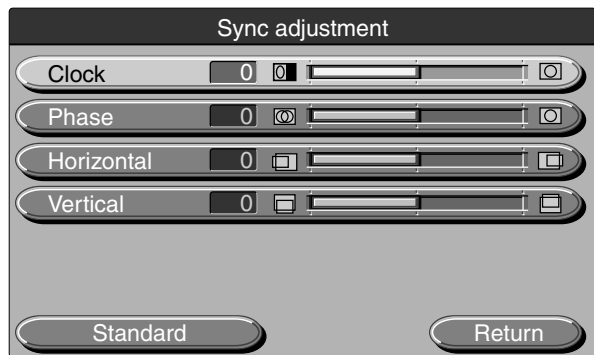

<Example: When “CLOCK” is selected>

### Main Unit Operation

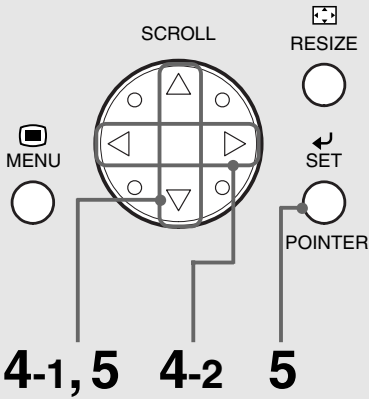

### Remote Control Operation

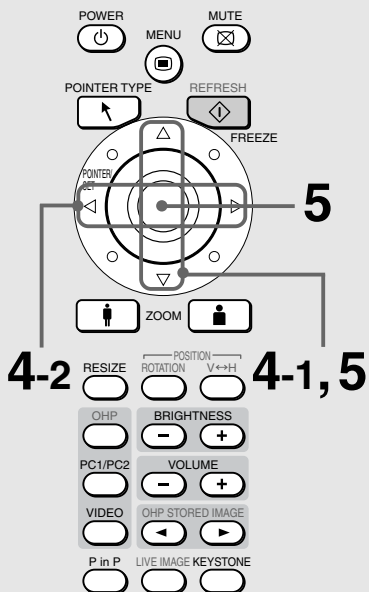

**4-2** Press the ◀/▶ buttons to adjust the setting.

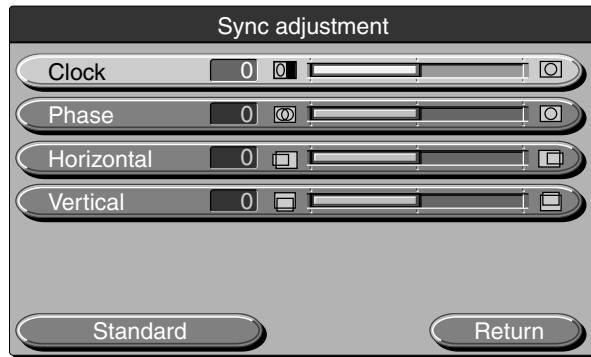

### Others

Other menu items include “Language selection”, “Projection mode” and “Video select”. For details of menu items, see page E-46.

**4-1** Press the ▲/▼ buttons to select the item you want to set.





<Example: When “English” is selected from the “Language Selection” menu>

**5** Press the ▲/▼ buttons to select “Quit” and then press the  button (or  button on the remote controller).

This returns the display to the main menu. The display automatically disappears, and adjustment values are stored to memory if buttons are not operated for about 30 seconds.

## Quick Menu

The Quick menu has frequently used items. This section describes the items and functions that can be set on the Quick menu.

Press the  button (or the  button on the remote controller) to display the quick menu.

### Description of Menu Items

#### ◆ When OHP Is Selected

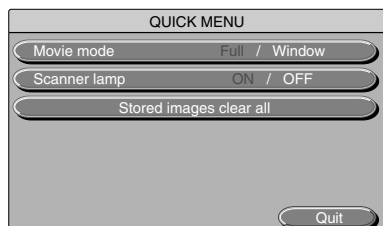

Menu Item	Setting Item	Description
Movie mode	Full/Window	When "Full" is selected: The entire projected image shows the video image. The document scanning speed is 1 frame per second. When "Window" is selected: The window on the bottom right side of the projected image shows the video image. The document scanning speed is 20 frames per second.
Scanner lamp*	ON/OFF	Sets whether the OHP scanner lamp is on or off.
Stored images clear all	—	Deletes the entire OHP stored images from the internal memory.

\*If the ambient temperature is low when the scanner lamp is turned ON, the OHP images will appear a little red.

#### ◆ When the OHP stored image Is Displayed



Menu Item	Setting Item	Description
Display the next stored image	—	Displays the image following the currently displayed image from stored image.
Display the previous stored image	—	Displays the image previous to the currently displayed image from stored image.
Stored images clear all	—	Deletes the entire OHP stored images from the internal memory.

#### ◆ When PC Input Is Selected



Menu Item	Setting Item	Description
Picture in Picture*	ON/OFF	Set this item to ON to display images, from the video source that is connected, in the window on the lower right side of the projected image.

\* Does not display without input from the computer.

#### ◆ When VIDEO Input Is Selected

No quick menu.

# Maintenance

## ■ Fault Protection

Your projector is provided with internal protection circuits for preventing fire and damage to internal components due to abnormal temperature.

### ● When the LAMP/COVER LED is blinking:

#### ○ Action

1. Disconnect the power plug from the power outlet.
2. Correctly install the air filter. For details, see “Cleaning the Air Filter” on page E-56.
3. Correctly install the lamp unit cover. For details, see “Lamp Unit Replacement” on page E-54.

### ● When the temperature LED is blinking or on.

#### ○ Action

1. Disconnect the power cord from the power outlet.
2. Check the following and take corrective actions.

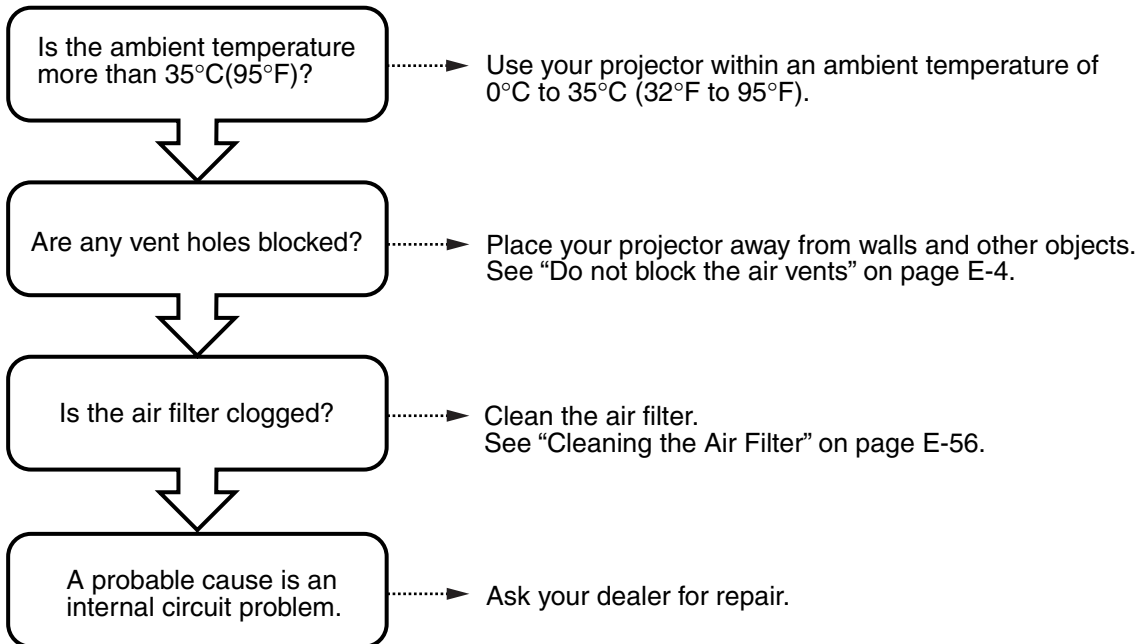

\* When the TEMP LED is OFF, your projector is working properly.

\* Replace the lamp at the same time when the LAMP/COVER LED is on.  
For details on how to replace the lamp, see page E-54.

\* A blinking TEMP LED is a warning that the temperature is too high. If the operating environment improves within 10 seconds after the LED starts blinking, the warning will stop. (When the TEMP LED goes out, normal operation continues.)

If the TEMP LED blinks for more than 10 seconds and the operating status does not change, the LED stops blinking and stays on and the lamp turns off.

- When the power fails (all LEDs are off when the power is turned ON)

- Action

1. Disconnect the power plug from the power outlet.
2. Check the following and take corrective actions.

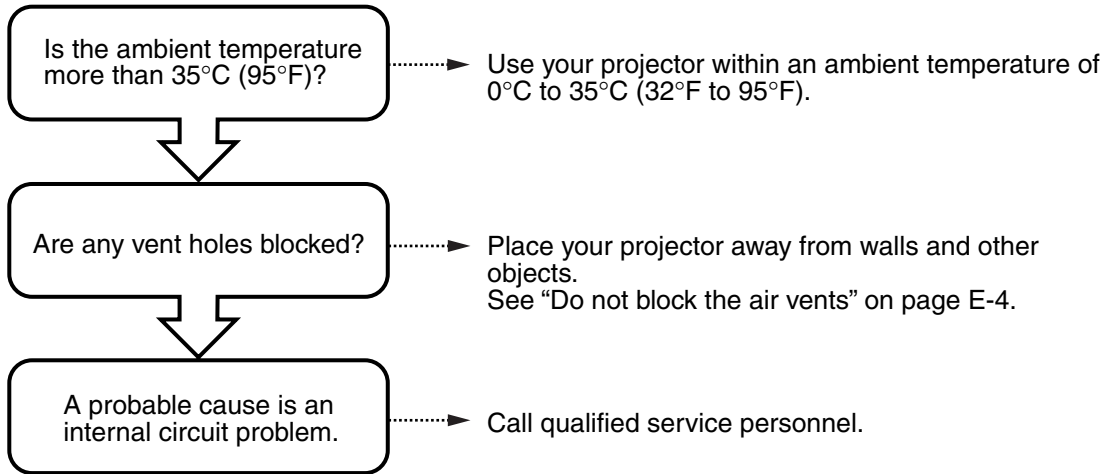

## ■ Lamp Unit Replacement

The target replacement time of the lamp used on this projector is 1400 hours. (This may be shortened depending on the conditions of use.) Since there is a high possibility of lamp explosion if the cumulative usage time exceeds more than 1500 hours, the power to the lamp is cut off at 1500 hours. In the following instances where the cumulative usage time of the lamp is more than 1400 hours, replace the lamp unit (sold separately). When the projected image becomes dark or projected colors are unsatisfactory, the lamp has reached the end of its life. In this case, replace the lamp unit.

- When the message shown below is displayed while the lamp is on (This appears when the cumulative usage time of the lamp is more than 1400 hours.)

Lamp usage 1400 hours.  
Replace the lamp.

- When “Lamp usage time” on the menu display has reached 1400 hours, the LAMP/COVER LED blinks red.  
The lamp usage time is displayed in the “Setting 1” menu for confirmation. (For details, see page E-45.)
- When the LAMP/COVER LED is on red without the lamp lighting.  
(When the cumulative usage time of the lamp is more than 1500 hours.)

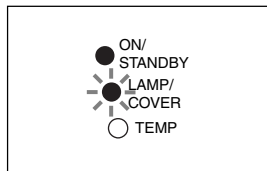

### WARNING

- Do not replace the lamp unit immediately after using the projector. The lamp is high temperature and you could get burned. Disconnect the power plug from the outlet and wait one hour or longer before replacing the lamp.
- Do not touch the glass portion of the lamp unit with your hands. Doing so could lower the brightness and shorten the life of the lamp.
- Many glass parts such as lamps, mirrors and other parts are used inside the projector. In the event that glass parts are broken, be very careful in handling the projector so that you are not injured by fragments and please request repair at your dealer of purchase or at one of our service centers.

### CAUTION

- There is no compatibility with the lamp units of other MP Series projectors. Please specify the dedicated lamp unit (model: MPLU-50).

## Procedure

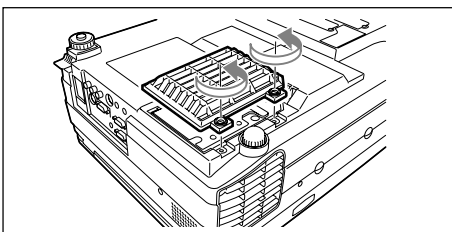

### 1 Remove the lamp unit cover.

Loosen the lamp unit cover screws using a flathead screwdriver.

## 2 Loosen the lamp unit retaining screws.

Loosen the lamp unit screws. (2 pieces)

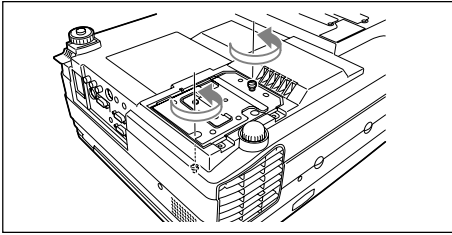

## 3 Draw out the lamp unit.

Hold the handle and lift the lamp unit upward.

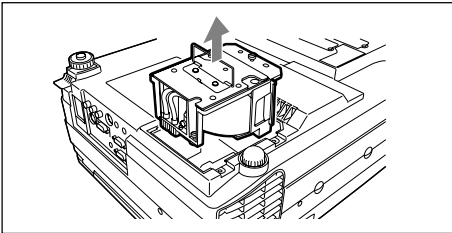

## 4 Install a new lamp unit.

- ① Hold the lamp unit and push it in.
- ② Make sure that the two positioning protrusions fit properly into the holes.
- ③ Tighten the two lamp unit retaining screws.
- ④ Align the three tabs on the lamp unit cover with the slots on the projector to attach it. Then tighten the two lamp unit cover retaining screws.

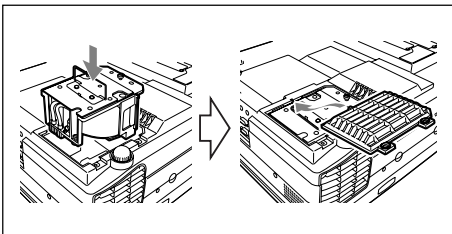

## 5 Reset the lamp usage time.

Perform the following in the standby state.

Press the , and buttons once in that order with the button held down.

The LAMP/COVER LED then blinks green.

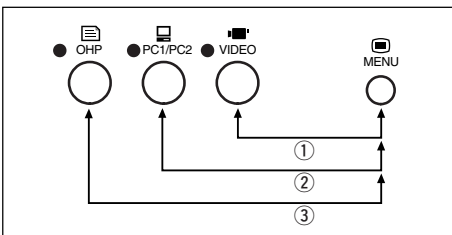

### CAUTION

*Do not reset the lamp usage time without replacing the lamp. The probability of a lamp explosion increases if the cumulative usage time of the lamp is more than 1500 hours.*

## 6 Verify that the display of lamp usage time in the Lamp Setting menu is "0H" as shown to the left.

If the lamp usage time is not reset, reset it by repeating step 5.

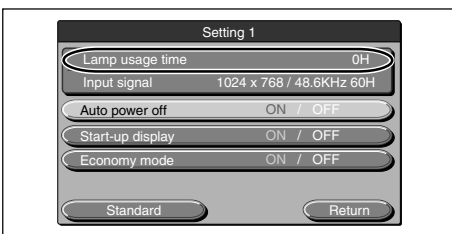

### CAUTION

*Be sure to reset the lamp usage time after replacing the lamp. Otherwise, the correct usage time cannot be known. When the display exceeds 1500 hours, the power to the lamp is forcibly turned off regardless of the lamp's life.*

### NOTE

- As a safety precaution, the lamp does not turn on unless the lamp unit cover is installed.
- The lamp unit sold separately comes with an air filter as part of the lamp kit. When replacing the lamp unit, be sure to replace the air filter as well. (See page E-56.)
- The lamp can be disposed as a regular household fluorescent light, follow the disposal procedure recommended by the local government.

## ■ Cleaning the Air Filter

The air filter is an important part as it keeps the optical components inside your projector free from dirt and dust. A clogged air filter can cause the temperature to rise inside your projector and the fan speed to increase. This, in turn, may reduce lamp life or cause the projector to malfunction. The air filter should be cleaned regularly (about once a month if the projector is used four hours a day).

Replace with a new air filter if it is difficult to remove dust and dirt from the air filter.

### Procedure

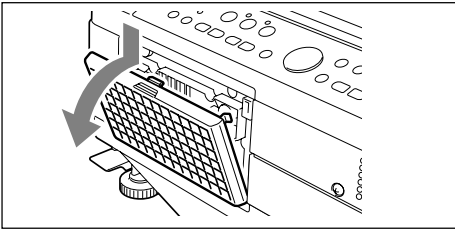

#### 1 Remove the air filter.

To remove the air filter, press down on the claw on the air filter while pulling it outwards.

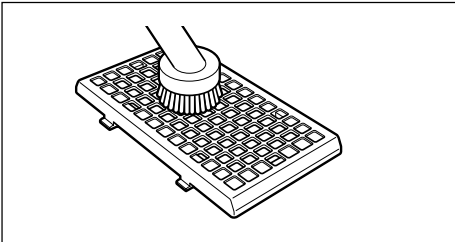

#### 2 Vacuum the sponge to take off dust.

Vacuum the outside surface of the sponge as shown in the illustration.

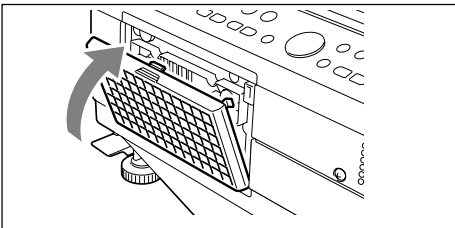

#### 3 Mount the air filter.

Follow step 1 in reverse order. Press it in until you hear a “click” sound.

### ⚠ CAUTION

#### Caring for the Air Filter and Cautions

- Do not wash the air filter with water or other liquids. This may cause the filter to clog.
- Do not wipe the air filter with a cloth or a wet rag as this, too, may cause the filter to clog.
- Always vacuum from the outside of the air filter. If you vacuum from the inside of the air filter, this will reduce the effectiveness of the air filter.
- Do not forget to install the air filter. If the projector is left without the air filter installed, dust may enter the projector and cause dirty projected images.
- When the air filter becomes damaged, be sure to replace it with a new one (sold separately). If the projector is used with the air filter damaged, dust may enter the projector and cause dirty projected images.

### NOTE

The lamp will not light unless the air filter is mounted.



# Troubleshooting

If you think a problem has occurred, check the following items before asking for a repair.

Symptom	To be Checked	Page(s)
Power is not on.	<ul style="list-style-type: none"> <li>Verify that the power cord is connected.</li> </ul>	E-20
The projection lamp does not light.	<ul style="list-style-type: none"> <li>Verify that the lamp has not blown.</li> <li>Verify that the lamp unit cover is installed.</li> <li>Verify that the air filter is installed.</li> <li>Verify the internal temperature. The lamp does not light due to a protection control if the temperature is too high.</li> <li>Verify that the lamp usage time is less than 1500 hours.</li> </ul>	E-54 E-54 E-56 E-52 E-54
No image is displayed.	<ul style="list-style-type: none"> <li>Verify the selection of the connected input.</li> <li>Verify that the cable for the connected device is appropriately connected.</li> <li>Verify sure that Brightness or Contrast in the Image Adjustment menu is not set to minimum.</li> <li>Verify that the resolution on the PC is correctly set.</li> <li>Verify the functions of the PC.</li> </ul>	E-29 E-22, 28 E-43 E-24 E-24
The image is distorted.	<ul style="list-style-type: none"> <li>Verify that the projector is placed properly.</li> <li>Keystone compensation may be applied.</li> </ul>	E-20 E-21
The image is blurred.	<ul style="list-style-type: none"> <li>Check the focus.</li> <li>Make sure that the projection distance is within the focusing distance.</li> <li>Keystone compensation may be applied.</li> <li>Verify whether the lens cap is on.</li> </ul>	E-30, 37 E-19 E-21 E-29
The image is flickering.	<ul style="list-style-type: none"> <li>Adjust Phase in the Sync Adjustment menu.</li> </ul>	E-44
The image is out of alignment.	<ul style="list-style-type: none"> <li>Check the setting of the Sync Adjustment menu.</li> </ul>	E-44
The color is out of alignment.	<ul style="list-style-type: none"> <li>Adjust Phase in the Sync Adjustment menu.</li> </ul>	E-44
No sound.	<ul style="list-style-type: none"> <li>Make sure that the setting in the Volume menu is not set to minimum.</li> </ul>	E-39
The cabinet produces a cracking sound.	<ul style="list-style-type: none"> <li>A sound is produced when the cabinet slightly expands or contracts due to the changes in the room temperature. This will not affect projector performance.</li> </ul>	—
The TEMP LED lights up or blinks.	<ul style="list-style-type: none"> <li>Follow the procedures for protection against overheating.</li> </ul>	E-52
The LAMP/COVER LED lights red.	<ul style="list-style-type: none"> <li>Make sure that the air filter is not disconnected.</li> <li>Make sure that the lamp unit cover is in place.</li> <li>Check whether the lamp usage has exceeded 1500 hours.</li> </ul>	E-56 E-54 E-54
The remote controller does not work.	<ul style="list-style-type: none"> <li>Make sure that the battery is not blown or worn.</li> <li>Make sure that other light from lighting, for example, is not entering the remote control sensor.</li> <li>Make sure that the remote control sensor of the main unit is not obstructed.</li> <li>Make sure that the projector is not installed near inverter-driven equipment.</li> </ul>	E-17 E-9, 10 E-9, 10 E-17
The image may not be positioned correctly or the display may be compressed, when personal computer input is selected.	<ul style="list-style-type: none"> <li>Press the RESIZE button to do automatic synchronous adjustment.</li> <li>Make adjustments on the "Synch adjustment" menu.</li> </ul>	E-38 E-44

# ***Repair Service***

---

## **Repair Service Procedure**

- Before asking for repair service, check the Troubleshooting section on page E-57 once more. If this check confirms a problem, contact the dealer where you bought the product.
- When asking for repair service, provide your dealer with the following information:
  - Description of the problem (as many details as possible)
  - Date of purchase
  - Your Name
  - Your Address
  - Telephone number
  - Product name and model No. (written on the label at the bottom of the projector)

# Specifications

Model Name		MP-50E		
Type	3 primary Color LCD Shutter Projection Type			
Main Part Specification	LCD Panel	Size	1.0 inches x 3 Panels, Aspect Ratio 4:3	
		Drive System	Poly Silicon TFT Active Matrix with Micro Lens Array	
		Number of Pixels	786,432 pixels (1,024 x 768 dots) × 3	
		Arrangement	Stripe	
	Projection Lens	Manual Zoom: 1 to 1.25x, f=36.5 mm to 45.6 mm, F1.7 to 2.2		
Optical Source	260W Super High-pressure Mercury Lamp			
Image Size	32-300 inches diagonal (projection distance 1.4 to 13.9 m)			
Color Reproducibility	Full color (16,770,000 colors)			
Brightness	3000 ANSI lumens			
Scan Frequency	Horizontal 21 to 80 kHz, Vertical 50 to 85 Hz			
Maximum Resolution	At RGB signal input	1,024 × 768 dots (Compressed display of 1,600 × 1,200 dots is possible.)		
Video Input/Output	OHP	Scanner	2 Mega-pixels color CCD camera 288 mm × 216 mm (11.3 in × 8.5 in)	
		PC (Analog RGB Input)	Signal system	Separate Signal System
			Video signal	Analog: 0.7Vp-p/75Ω
			Sync Signal	Separate/composite: TTL Level (positive/negative) Sync on green: 0.3 Vp-p (Negative)
	Video	Terminal Panel	15 pin Mini D-sub 2 ch	
		Signal system	NTSC/PAL/SECAM/PAL-N/PAL-M/NTSC4.43	
		Input Terminal	RCA Pin Jack 1 ch, S-Video (Mini DIN4-pin) 1ch	
	Monitor Output	Video signal	0.7Vp-p/75Ω	
		Sync Signal	Separate TTL Level, Negative Polarity	
Output Terminal		15 pin Mini D-sub 1 ch		
Audio input/output	PC	Audio Signal	0.4Vrms/47KΩ	
		Input Terminal	Stereo Mini Jack 2 ch	
	Video	Audio Signal	0.4Vrms/47KΩ	
		Input Terminal	RCA Pin Jack 1 ch	
	Monitor Output	Audio Signal	0.4Vrms/47KΩ	
		Output Terminal	Stereo Mini Jack 1 ch	
Audio Output	1 W × 2 stereo			
Operating Range of Temperature and Humidity	Temperature: 0 to 35°C (32 to 95°F), humidity: 20 to 80% (no condensation)			
Power Source	100-120/220-240VAC , 50/60 Hz			
Power Consumption	390W (100-120VAC), 370W (220-240VAC)			
Input Current	4.5A (100-120VAC), 2.2A (220-240VAC)			
External Dimensions (mm/in)	400 (W) × 315 (D) × 145 (H) /15.7 (W) × 12.4 (D) × 5.7 (H) (not including protrusions, Including the cover)			
Weight	7.3kg			
Accessories	Power Cord (3 m/3.3 yd), Remote Control, User's Manual, Battery (AA x 2), PC cable, Lens cap			

• Specifications and designs are subject to change without prior notice in order to improve the product.

LCD panels are inherently susceptible to pixel defects.  
The specifications are subject to change without notice.