

myprojectorlamps.com

**The most trusted, dependable name
in projector lamp sales.**



<http://www.myprojectorlamps.com>



<http://www.myprojectorlamps.ca>



<http://www.myprojectorlamps.eu>

The following projector manual has not been modified or altered in any way.



M6

Reference Guide



ASK Proxima

Declaration of Conformity

Manufacturer: InFocus Corporation, 27500 SW Parkway Avenue, Wilsonville, Oregon 97070 USA

European Office: Louis Armstrongweg 110, 1311 RL Almere, The Netherlands

We declare under our sole responsibility that this projector conforms to the following directives and norms:

EMC Directive 89/336/EEC, Amended by 93/68/EEC

EMC: EN 55022

EN 55024

EN 61000-3-2

EN 61000-3-3

Low Voltage Directive 73/23/EEC, Amended by 93/68/EEC

Safety: IEC 60950-1: 1st Edition

May, 2004

Trademarks

Microsoft, PowerPoint, Word, Excel and Windows are trademarks or registered trademarks of Microsoft Corporation. Digital Light Processing is a trademark or registered trademark of Texas Instruments. Adobe and Acrobat are trademarks or registered trademarks of Adobe Systems Incorporated. InFocus, In Focus, and INFOCUS (stylized) are either registered trademarks or trademarks of InFocus Corporation in the United States and other countries.

FCC Warning

This equipment has been tested and found to comply with the limits for a Class A digital device, pursuant to part 15 of the FCC Rules. These limits are designed to provide reasonable protection against harmful interference when the equipment is operated in a commercial environment. This equipment generates, uses, and can radiate radio frequency energy and, if not installed and used in accordance with the instruction manual, may cause harmful interference to radio communications. Operation of this equipment in a residential area is likely to cause harmful interference in which case the user will be required to correct the interference at his own expense.

Changes or modifications not expressly approved by InFocus Corporation may void authority to operate the equipment.

EN 55022 Warning

This is a Class A product. In a domestic environment it may cause radio interference, in which case the user may be required to take adequate measures. The typical use is in a conference room, meeting room or auditorium.

Canada

This Class A digital apparatus complies with Canadian ICES-003.

Cet appareil numérique de la classe A est conforme à la norme NMB-003 du Canada.

Agency Approvals

UL, CUL, TUV

Other specific Country Approvals may apply, please see product certification label.

This user's guide applies to models IN10, M6, LP70+, and M2+.

InFocus reserves the right to alter product offerings and specifications at any time.

Table of Contents

Introduction	3
Connecting a computer	5
Required computer connections	5
Displaying a computer image	6
Adjusting the image	7
Connecting a video device	8
Shutting down the projector	9
Troubleshooting your setup	9
Using the keypad buttons	16
Using the remote control	17
Optimizing computer images	18
Presentation features	18
Optimizing video images	18
Customizing the projector	18
Using the menus	19
Picture menu	20
Settings menu	23
Maintenance	26
Cleaning the lens	26
Cleaning the lamp filter screens	26
Using the security lock	26
Replacing the projection lamp	27
Appendix	29
Projected image size	29

Important Operating Considerations for Safety

- Place the projector in a horizontal position no greater than 15 degrees off axis.
- Locate the projector in a well-ventilated area without any obstructions to intake or exhaust vents. Do not place the projector on a tablecloth or other soft covering that may block the vents.
- Locate the projector at least 4' (1.2 m) away from any heating or cooling vents.
- Use only the power cord provided. A surge-protected power strip is recommended.
- Refer to this guide for proper startup and shutdown procedures.
- **Warning:** Hg – Lamp contains mercury. Manage in accordance with local disposal laws. See www.lamprecycle.org.
- In the unlikely event of a lamp rupture, particles may exit through the projector side vents. When the projector is turned on, keep people, food, and drinks out of the "keep out" area around the projector, as indicated by the "X" area below.

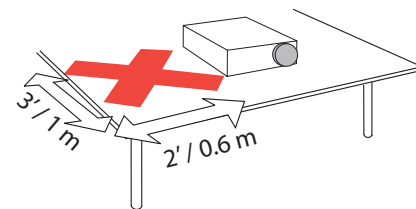

Follow these instructions to help ensure image quality and lamp life over the life of the projector. Failure to follow these instructions may affect the warranty. For complete details of the warranty, see the Warranty booklet.

Introduction

Your new XGA 1024x768 resolution digital projector is specifically designed for portability, connectivity, and collaboration. It is easy to connect, easy to use, easy to transport, and easy to maintain

Product specifications

To read the latest specifications on your multimedia projector, be sure to visit our website at www.infocus.com, as specifications are subject to change.

Accessories

The standard accessories that came with your projector are listed in the included user's guide. Optional accessories can be found on our website at www.infocus.com or at your retailer or dealer.

Online Registration

Register your projector on our website at www.infocus.com/register to activate your warranty and receive product updates, announcements, and registration incentives.

Projector components and features

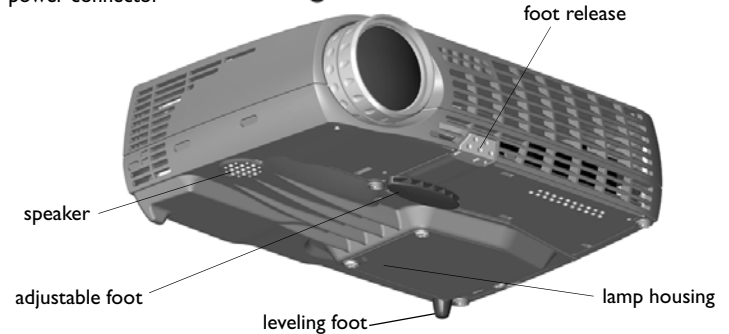
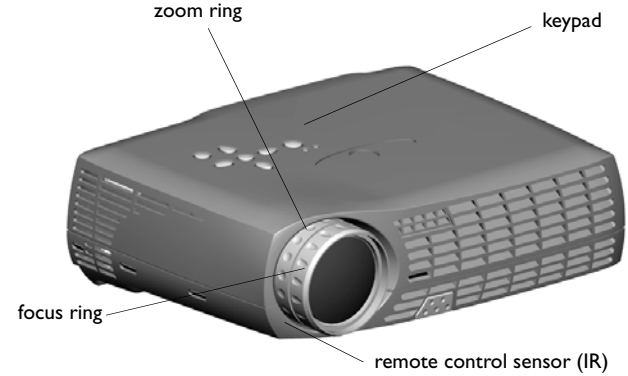

Connector Panel

The projector provides computer and video connectors:

- one M1-D/A (HD, DVI, and computer)
- one S-video
- one composite RCA video
- one audio in

Connector panel

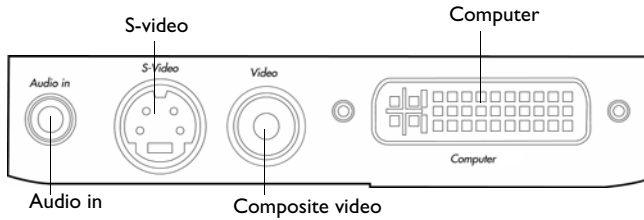

Connecting a computer

Required computer connections

Connect the black end of the computer cable to the **Computer** connector on the projector. Connect the blue end to the video port on your computer. If you are using a desktop computer, you first need to disconnect the monitor cable from the computer's video port.

Some Macintosh® computers do not have a standard VESA-out video port. If the supplied computer cable will not connect to your computer, purchase the appropriate adapter from your Apple® reseller.

Connect the black power cable to the connector on the back of the projector and to your electrical outlet.

The LED turns amber.

NOTE: Always use the power cable that shipped with the projector.

Optional computer connections

To advance slides in a PowerPoint™ presentation using the up and down arrow buttons on the remote, plug the USB connector on the computer cable into the USB mouse connector on your computer.

To have sound with your presentation, connect an audio cable (sold separately) to your computer and to the **Audio In** connector on the projector.

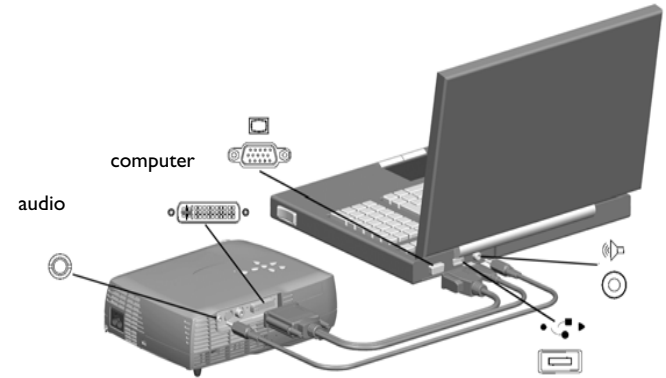

Displaying a computer image

Remove the lens cap.

remove lens cap



Press the **Power** button on the top of the projector or the remote.

press Power button

The LED blinks green and the fans start to run. When the lamp comes on, the start up screen displays and the Power light is steady green. It can take a minute for the image to achieve full brightness.



? **No startup screen?** Get help on page 9.

Turn on your computer.

turn on computer

The computer's image should appear on the projection screen. If it doesn't, press the **Source** button.



Make sure your laptop's external video port is active.

activate laptop's external port

Many laptops do not automatically turn on their external video port when a projector is connected. Usually a key combination like FN + F8 or CRT/LCD key turns the external display on and off. Locate a function key labeled CRT/LCD or a function key with a monitor symbol. Press FN and the labeled function key simultaneously. **Refer to your laptop's documentation to learn your laptop's key combination.**

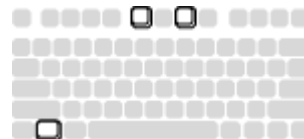

? **No computer image?** Get help on page 9.

Adjusting the image

Adjust the height of the projector, if necessary, by pressing the release button to extend the elevator foot.

Rotate the leveling foot (located at the bottom back left corner), if necessary.

Position the projector the desired distance from the screen, so that the lens is perpendicular to the screen.

See page 29 for a table listing screen sizes and distances.

Adjust the zoom or focus rings by rotating them until the desired image size and focus are produced.

If the image is not square, adjust the vertical digital keystone by using the buttons on the keypad. Press the upper **Keystone** button to reduce the upper part of the image, and press the lower **Keystone** button to reduce the lower part.

You can also adjust the keystone via the menus. See page 20.

Adjust the Contrast or Brightness in the Picture menu.

See page 19 for help with the menus.

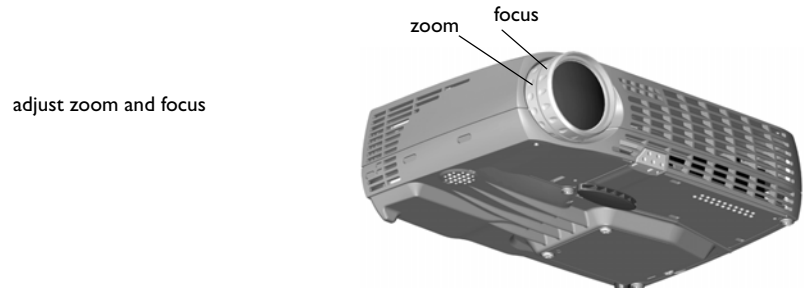
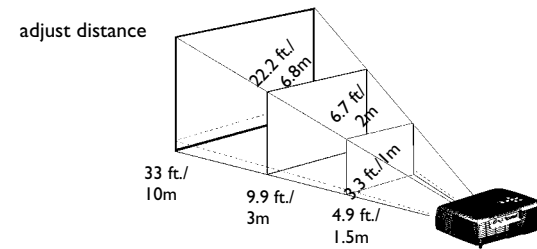
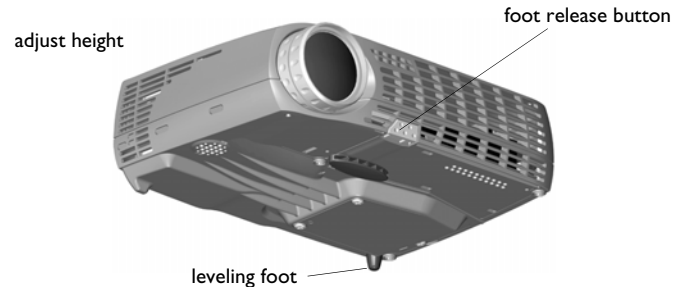

Connecting a video device

If your video device uses a round, four-prong S-video connector, plug the S-video cable into the S-video Out connector on the video device and into the **Video 1** connector on the projector. If the device uses a composite video connector, plug the composite video cable into the Composite Out connector on the video device and into the **Video 2** connector on the projector.

For audio, plug a mini-plug audio Y-cable into the **Audio in** connector on the projector and into the video device's left and right audio out connectors.

Connect the black power cable to the connector on the back of the projector and to your electrical outlet.

NOTE: Always use the power cable that shipped with the projector.

connect S-video and audio cables

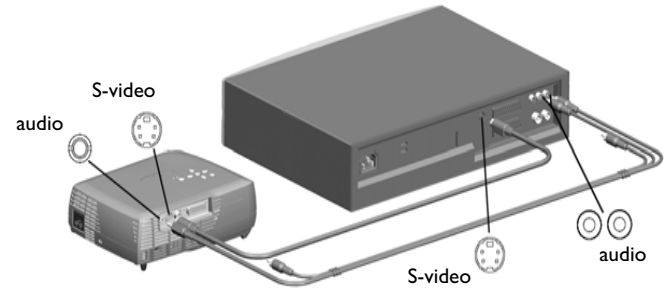

connect composite video and audio cables

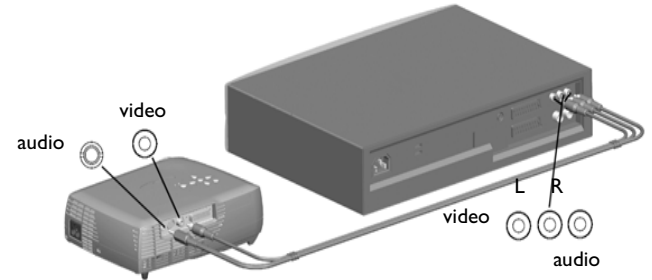

Shutting down the projector

The projector automatically blanks the screen after no active source is detected for 30 minutes. This blank screen helps preserve the life of the projector. The image returns when an active source is detected or a remote or keypad button is pressed.

Screen Save

You can make the blank screen appear after five minutes by turning on Screen Save in the **Settings>System** menu. See page 24. There are six time options for the Screen Save feature. They range from five minutes to 30 minutes with five minute intervals.

Power Save

The projector also has a Power Save feature that automatically turns the lamp off after no signal is detected for 20 minutes. After 10 additional minutes with no signal, the projector powers down. If an active signal is received before the projector powers down, the image is displayed. You must press the **Power** button to display an image after 30 minutes have passed. When Power Save is enabled, Screen Save is disabled. See page 24.

Turning off the projector

To turn off the projector, press the **Power** button and verify that you want to turn the projector off by pressing the **Power** button again within 3 seconds. You can cancel the shutdown by not pressing the **Power** button a second time. The lamp turns off and the LED blinks amber for 1 minute while the fans continue to run to cool the lamp. When the lamp has cooled, the LED lights amber and the fans stop. Unplug the power cable to completely power off the projector.

Troubleshooting your setup

If your image appears correctly on the screen, skip to the next section (page 17). If it does not, troubleshoot the setup.

LEDs

The Lamp LED on top of the projector (page 16) will alert you to certain problems.

A solid red Lamp LED means it is time to change the lamp. See page 27.

A blinking red Lamp LED means different things based on the number of “blinks”. After blinking 1-5 times, the light turns off for 2 seconds, then the blinking repeats.

- 1 blink, lamp won't turn on: Turn the projector off for at least one minute, then turn it on again. If the blinking continues, the lamp may need to be replaced.
- 2 blinks: Remaining lamp life is low. Replace the lamp, see page 27.
- 3 or 4 blinks: Unexpected shut down (3 blinks) or fan failure (4 blinks). Turn the projector off for at least one minute, then turn it on again. If the blinking continues, the projector may require service; go to www.infocus.com/support.
- 5 blinks: The projector is overheating. Turn the projector off and remove anything that may be blocking its air vents. Leave the projector off for at least one minute to let it cool before turning it on again. Important: Continuous operation at high temperature may reduce the lifetime of the lamp and/or projector.

The other LED on top of the projector indicates the normal operating state of the projector.

- A solid green LED means the projector is on.
- A blinking green LED means the lamp is turning on. A green “blip” means the projector is in Screen Save or Power Save mode.
- A blinking amber LED means the lamp is either warming up or cooling down to enter standby mode; a solid amber LED means the projector is in standby mode.

Source Troubleshooting

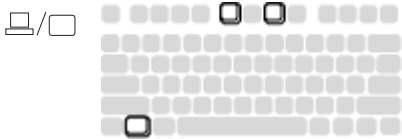
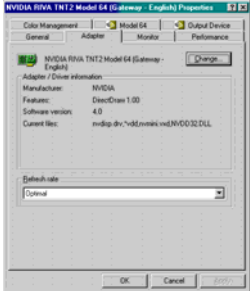
Problem	Solution	Result
<p>No startup screen</p>	<p>Plug power cable in, press Power button. Remove lens cap.</p>	<p>Correct image</p>
<p>Only startup screen appears</p>	<p>Press the Source button  Activate laptop's external port</p>  <p>or restart laptop</p>	<p>Computer image projected</p>
<p>No computer image, just the words “Signal out of range”</p>	<p>Adjust computer refresh rate in Control Panel>Display>Settings>Advanced>Adapter (location varies by operating system)</p>  <p>You may also need to set a different resolution on your computer, as shown in the following problem.</p>	<p>Computer image projected</p>

For PC: Image fuzzy or cropped

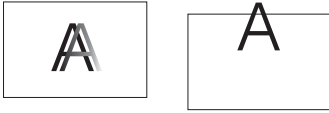

Set your computer's display resolution to the native resolution of the projector (Start>Settings>Control Panel>Display>Settings tab, select 1024x768)

For a laptop, disable laptop monitor or turn-on dual-display mode



Image clear and not cropped



For Macintosh: Image fuzzy or cropped

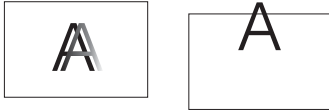

Set your computer's display resolution to the native resolution of the projector (Apple menu>System Preferences>Displays, choose 1024x768)

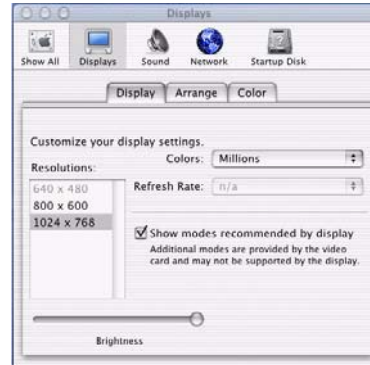
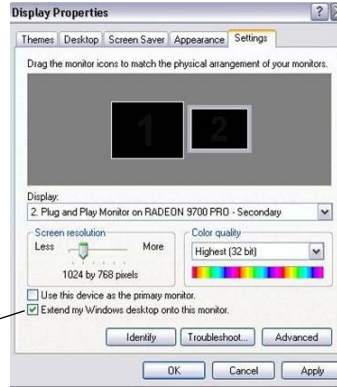

Image clear and not cropped



Only my laptop's background appears, not the Desktop icons

Disable "Extend my Windows Desktop" in Control Panel>Display>Settings>Display 2 (location varies by operating system)



Background and Desktop projected





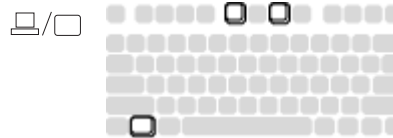

The video embedded in my PowerPoint presentation does not play on the screen



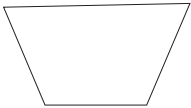
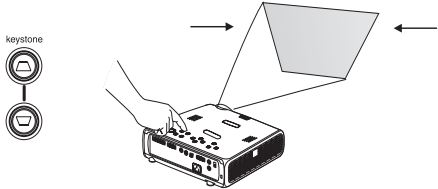

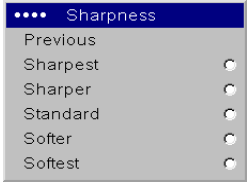
Turn off the internal LCD display on your laptop

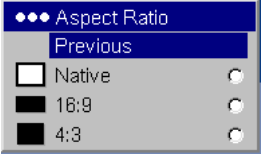

Embedded video plays correctly

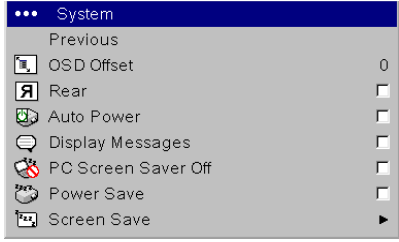
Projector troubleshooting

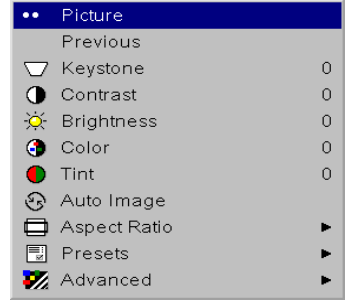
Problem	Solution	Result
<p data-bbox="48 181 251 207">Image not square</p> 	<p data-bbox="661 181 1159 207">Adjust keystone on keypad or Picture menu</p> 	<p data-bbox="1183 181 1345 207">Square image</p> 
<p data-bbox="48 448 239 475">Image not sharp</p> 	<p data-bbox="661 448 1159 498">Adjust the focus lens or Sharpness in the Picture>Advanced menu</p> 	<p data-bbox="1183 448 1357 475">Correct image</p> 
<p data-bbox="48 740 390 766">Image does not fit 16:9 screen</p> 	<p data-bbox="661 740 1008 789">Change aspect ratio to 16:9 in Picture>Aspect ratio menu</p> 	<p data-bbox="1183 740 1357 766">Correct image</p> 

<p>Image reversed left to right</p> 	<p>Turn off Rear in Settings>System menu</p> 	<p>Correct image</p> 
<p>Projected colors don't match source</p> 	<p>Adjust color, tint, color temperature, brightness, contrast in the menus</p> 	<p>Correct image</p> 
<p>Image not centered on screen</p>	<p>Move projector, adjust zoom, adjust height Adjust horizontal or vertical position in Picture>Advanced menu</p>	<p>Correct image</p>
<p>Lamp won't turn on, Lamp LED is blinking red (5 blinks)</p>	<p>Make sure vents aren't blocked; allow projector to cool for one minute</p>	<p>Unplug projector; wait one minute; plug in projector and turn it on: lamp lights</p>

“Change lamp” message appears at startup, lamp won’t turn on, lamp won’t turn on, Lamp LED is blinking red (2 blinks)

Lamp must be replaced (page 27)



Lamp turns on

Still having problems?

If you need assistance, visit the Service and Support section of our website or call us.

This product is backed by a limited warranty. An extended warranty plan may be purchased from your dealer. When sending the projector in for repair, we recommend shipping the unit in its original packing material, or having a professional packaging company pack the unit. Please insure your shipment for its full value.

Using the keypad buttons

Most buttons are described in detail in other sections, but here is an overview of their functions:

power—turns the projector on (page 6) and off.

menu—opens the on-screen menus (page 19).

source/select—confirms choices made in the menus and selects sources (page 19).

up/down/left/right arrows—navigates to and adjusts settings in the menus (page 19).

keystone—vertical keystone adjusts the squareness of the image (page 7). You can also adjust the keystone via the menus. See page 20.

volume—adjusts sound (page 18).

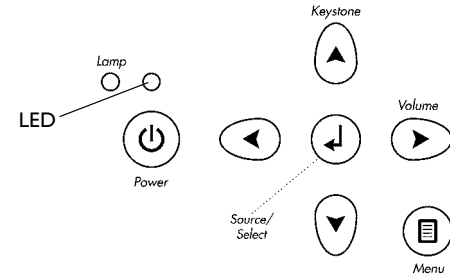

Using the remote control

The remote uses two (2) AA batteries. They are easily installed by sliding the cover off the remote's back, aligning the + and - ends of the batteries, sliding them into place, and then replacing the cover.

Caution: When replacing the batteries, be aware that using batteries other than the type provided with the projector may risk severe damage to the remote. When disposing of the batteries, be sure to do so in an environmentally proper manner.

To operate, point the remote at the front of the projector (not at the computer). The range of optimum operation is about 15 feet (4.5m).

Press the remote's **Power** button to turn the projector on and off (see page 9 for shutdown info).

Press the remote's **Menu** button to open the projector's menu system. Use the arrow buttons to navigate, and the **Select** button to select features and adjust values in the menus. See page 19 for more info on the menus.

The remote also has a **Source** button to switch between sources.

If you connect the USB portion of the M1-DA computer cable (page 5) you can use the up and down arrow navigation buttons to advance slides in a PowerPoint presentation.

Troubleshooting the remote

- Make sure the batteries are installed in the proper orientation and are not dead.
- Make sure you're pointing the remote at the projector or the screen, not the computer, and are within the remote range of 15 feet (4.5m). For best results, point the remote at the projector.

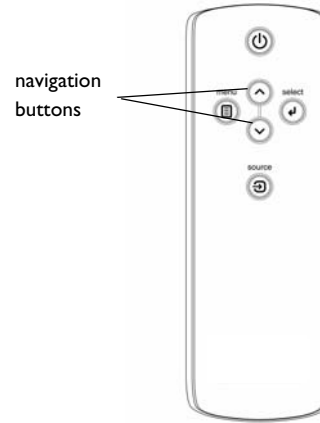

Optimizing computer images

After your computer is connected properly and the computer's image is on the screen, you can optimize the image using the onscreen menus. For general information on using the menus, see page 19.

- Adjust the Keystone, Contrast, or Brightness in the Picture menu.
- Change the Aspect Ratio. See page 20 for details.
- Adjust the Color Space, Temperature or Control in the Advanced menu.
- Adjust the Phase, Tracking, or Horizontal or Vertical position in the Advanced menu.
- Once you have optimized the image for a particular source, you can save the settings using Presets. This allows you to quickly recall these settings later. See page 21.

Presentation features

Several features are provided to make giving presentations easier. The following is an overview, details are found in the menu section on page 19.

- The Custom key, available on several optional remotes only, allows you to assign various features to the button. See page 25 for details.
- The Startup Logo menu option lets you change the default startup screen to a black, white, or blue screen. See page 24.
- Two menu options, Power Save and Screen Save, are provided to automatically shut down the projector after several minutes of inactivity or display a blank screen. This helps preserve lamp life. See page 24.

Optimizing video images

After the video device is connected properly and the image is on the screen, you can optimize the image using the onscreen menus. For general information on using the menus, see page 19.

- Adjust the Keystone, Contrast, Brightness, Color, or Tint in the Picture menu. See page 20.
- Change the Aspect ratio. Aspect ratio is the ratio of the image width to image height. TV screens are usually 1.33:1, also known as 4:3. HDTV and most DVDs are 1.78:1, or 16:9. Choose the option that best fits your input source. See page 20.
- Select a Sharpness, Color Temperature, or Video Standard setting. See page 22.
- Adjust the Color Control or White Peaking settings. See page 22.

Customizing the projector

You can customize the projector for your specific setup and needs. See page 23 for details on these features.

- For rear projection, turn Rear mode on in the **Settings>System** menu.
- Specify which source the projector checks first for active video during power-up.
- Specify the function of the Custom Key on the optional remote.
- Turn the projector's display messages on and off.
- Turn on power saving features.
- Specify blank screen colors and startup logos.
- Specify the menu language.
- Control your projector using RS-232 commands.

Using the menus

To open the menus, press the **Menu** button on the keypad or remote. (The menus automatically close after 60 seconds if no buttons are pressed.) The Main menu appears. Use the arrow buttons to move up and down to highlight the desired submenu, then press the **Select** button.

To change a menu setting, highlight it, press **Select**, then use the up and down arrow buttons to adjust the value, select an option using radio buttons, or turn the feature on or off using check boxes. Press **Select** to confirm your changes. Use the arrows to navigate to another setting. When your adjustments are complete, navigate to Exit, then press **Select** to go to the previous menu; press the **Menu** button at any time to close the menus.

Dots appear before the menu name. The number of dots indicate the menu's level, ranging from one (the Main menu) to four (the most nested menus).

The menus are grouped by usage:

- The Picture menu provides image adjustments.
- The Settings menu provides set-up type adjustments that are not changed often.
- The Source Info menu provides a read-only display of information about the projector and source.

Certain menu items may be grayed out until a particular source is connected. For example, Sharpness is only available for video sources and will be hidden when a computer source is active. Other menu items may be grayed out when they are not available. For example, Brightness is grayed out until an image is active.

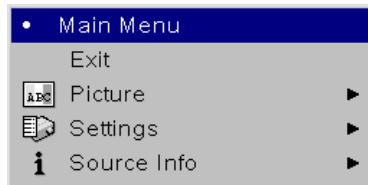

Main menu

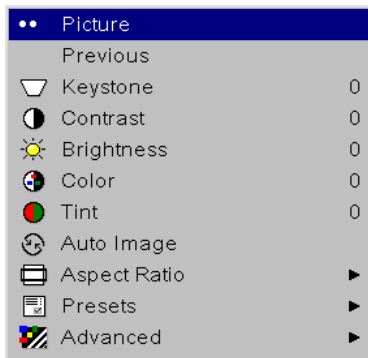
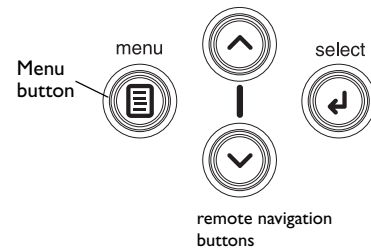

Picture menu

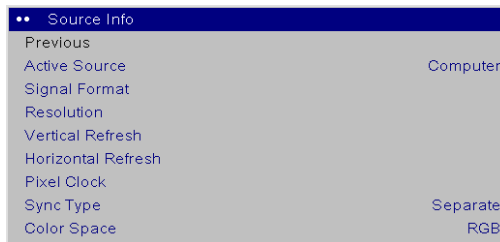
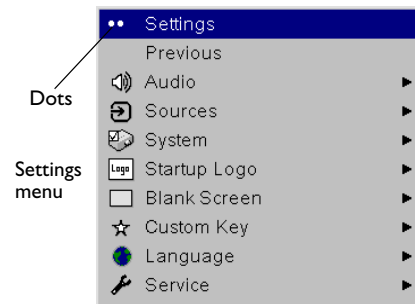

Source Info menu

Picture menu

To adjust the following six settings, highlight the setting, press **Select**, use the up and down arrows to adjust the values, then press select to confirm the changes.

Keystone: adjusts the image vertically and makes a squarer image. You can also adjust keystone from the keypad.

Contrast: controls the degree of difference between the lightest and darkest parts of the picture and changes the amount of black and white in the image.

Brightness: changes the intensity of the image.

Color: (video and component sources only) adjusts a video image from black and white to fully saturated color.

Tint: (NTSC video sources only) adjusts the red-green color balance in the image.

Auto Image: resynchs the projector to the source.

Aspect Ratio: Aspect ratio is the ratio of the image width to image height. TV screens are usually 1.33:1, also known as 4:3. HDTV and most DVDs are 1.78:1, or 16:9. The default is 4:3, which displays the input resized up or down to fill the display area.

The aspect ratio selection is saved for each source.

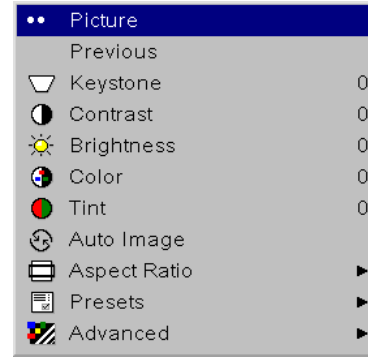

increasing keystone

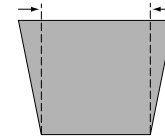

decreasing keystone

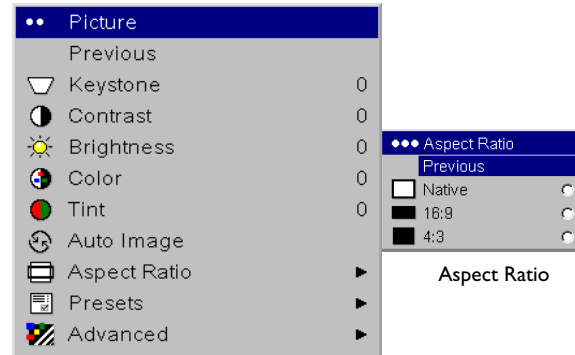
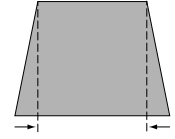

Presets: Presets are provided that optimize the projector for displaying computer presentations, film images, and video images. Film input is material originally captured on a film camera, like a movie; video input is material originally captured on a video camera, like a TV show or sporting event.

There are also user-definable presets. To set a preset for the current source, adjust the image, select Save Settings in the Presets menu, then select Save User 1 (or 2 or 3). You can recall these settings in the future by selecting the User 1 preset.

If you make any adjusts the image, Presets Off will automatically be selected in the Preset menu to indicate changes have been made.

To restore the factory default settings, choose Factory Reset in the **Settings>Service** menu.

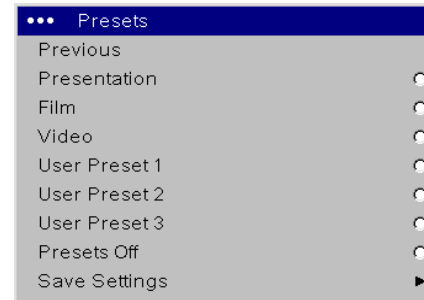

Presets

Advanced settings

The following 4 options are for computer and component sources only.

Phase: adjusts the horizontal phase of a computer source.

Tracking: adjusts the vertical scan of a computer source.

Horizontal/Vertical Position: adjusts the position of a computer source.

Sync Threshold Adjust: (enhanced and high definition sources only) If a hardware device, such as a DVD player, is not syncing properly with the projector, select this option to help it sync.

White Peaking: (video sources only) adjusts the white level processed in the image. It increases the brightness of whites that are near 100%.

Overscan: (video sources only) removes noise around the video image.

Sharpness: (video sources only) changes the clarity of the edges of a video image. Select a sharpness setting.

Color Space: This option applies to computer sources. It allows you to select a color space that has been specifically tuned for the video input. When Auto is selected, the projector automatically determines the standard. To choose a different setting, turn off Auto, then choose RGB for computer sources, choose either REC709 or REC601 for component sources.

Color Temperature: changes the intensity of the colors. Select a listed value.

Color Control: allows you to individually modify each color. Highlight the color, press **Select**, then use the arrows to adjust the value.

Video Standard: (video sources only) When it is set to Auto, the projector attempts to pick the video standard automatically based on the input signal it receives. (The video standard options may vary depending on your region of the world.) If the projector is unable to detect the correct standard, the colors may not look right or the image may appear “torn.” If this happens, manually select a video standard by selecting NTSC, PAL, or SECAM from the Video Standard menu.

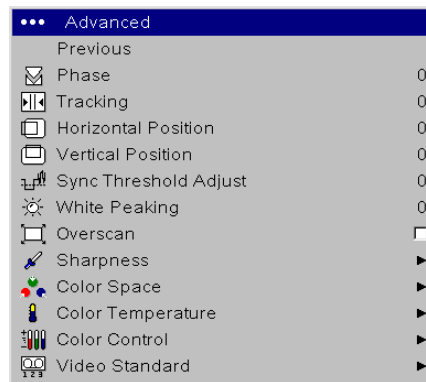

Advanced



Sharpness

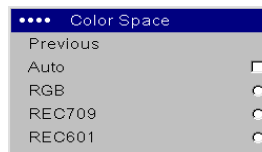

Color Space

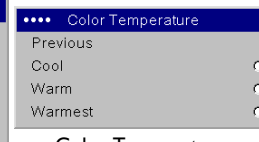

Color Temperature



Color Control

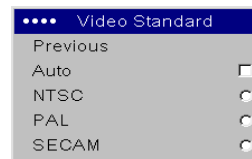

Video Standard

Settings menu

Audio: allows adjustments to the volume.

Sources: allows you to assign a particular input to a specific source key when using an optional remote. Also allows selection of a default Power-up Source and enables or disables Autosource.

Sources>Autosource: When Autosource is not checked, the projector defaults to the source selected in Power-up Source. If no source is found, a blank screen displays. When Autosource is checked, Power-up Source determines which source the projector defaults to at startup. If no signal is present, the projector checks the sources in order until a source is found or until power down.

Sources>Power-up Source: this determines which source the projector checks first for active video during power-up.

Sources>Source Enable: When **Autosource** is selected, the **Source Enable** feature indicates which sources the projector attempts to lock onto. You can use the Source Enable feature to eliminate certain sources from this search, which will speed the search. By default, the check boxes for all sources are checked.

System>OSD Offset: allows you to adjust the position of the OSD. By default, the menus are positioned in the upper lefthand corner of the display image and the messages are positioned in the lower lefthand corner. Adjust the offset to move these items more to the right and middle of the display.

Rear: reverses the image so you can project from behind a translucent screen.

Auto Power: When Auto Power is checked, the projector automatically goes into the startup state after the projector is powered on.

Display Messages: displays status messages (such as “Searching” or “Mute”) in the lower-left corner of the screen.

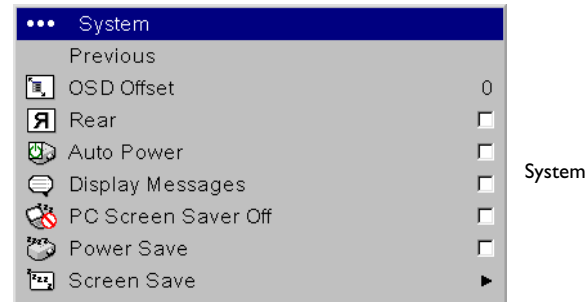
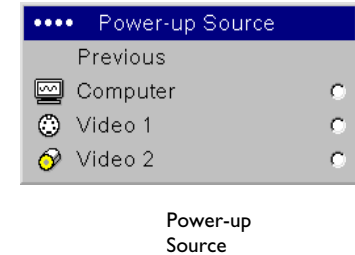
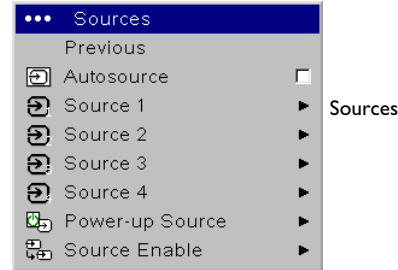
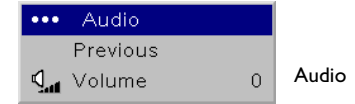
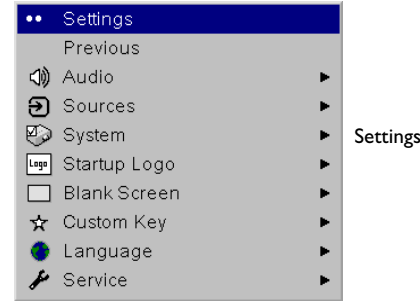

PC Screen Saver Off: prevents your computer from going into Screen Save mode. This feature is only available if the USB portion of the computer cable is connected to your computer (page 5).

Power Save: automatically turns the lamp off after no signals are detected for 20 minutes. After 10 additional minutes with no signal, the projector powers down. If an active signal is received before the projector powers down, the image will be displayed.

Screen Save: automatically blanks the screen with a black color after no signals are detected for a preset number of minutes. The image returns when an active source is detected or a remote or keypad button is pressed. Screen Save is disabled when Power Save is enabled.

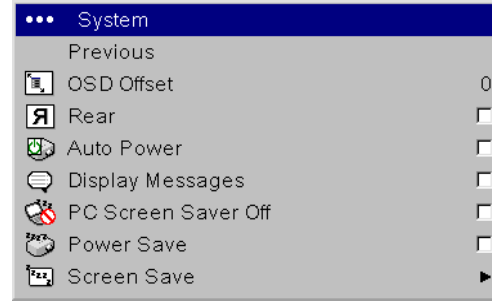

System

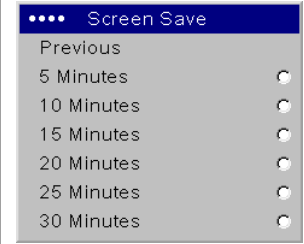

Screen Save

Startup Logo: allows you to display a blank Black, White, or Blue screen instead of the default screen at startup and when no source is detected.



Startup Logo

Blank Screen: determines what color is displayed when no source is detected.

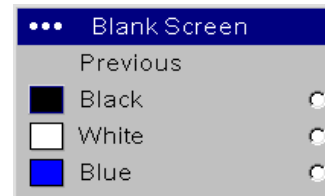

Blank Screen

Custom Key (for use with optional remote only): allows you to assign a different function to the **Custom** button on the remote to quickly and easily use the effect. Only one effect can be enabled at a time. Highlight an effect and press **Select** to choose a different one. The default effect is About.

- **Blank:** displays an empty screen.
- **Mute:** turns off all sound.
- **Aspect Ratio:** toggles among 4:3, 16:9, and Native (see page 20).
- **Source:** cycles through available sources.
- **Auto Image:** resets the projector to the source.
- **Freeze:** pauses the projected image.
- **Source Info:** the default effect. It opens a window with projector and source information.
- **Service Info:** opens a window with projector and source information.

Language: allows you to select a language for the onscreen display of menus and messages.

Service: to use these features, highlight them and press **Select**.

Factory Reset: restores all settings (except Lamp Hours) to their default after displaying a confirmation dialog box.

Reset Lamp Hours: resets the lamp hours counter in the Service Info menu to zero. Do this only after changing the lamp. It displays a confirmation dialog box.

Test Pattern: allows you to display certain patterns to adjust the image. This feature only works with an optional remote. To display test patterns, click the Test Pattern check box, exit the menus, then press the **Blank** button on the remote. To select the patterns, use the up/down arrows on the remote or keypad. To exit the test patterns, press the **Blank** button again.

Service Info: provides information about the projector and lamp.

Service Code: only used by authorized service personnel.

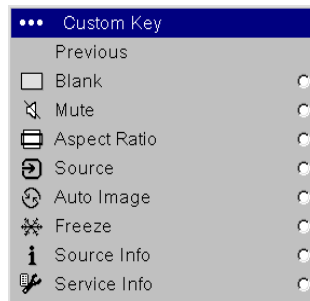

Custom Key



Language

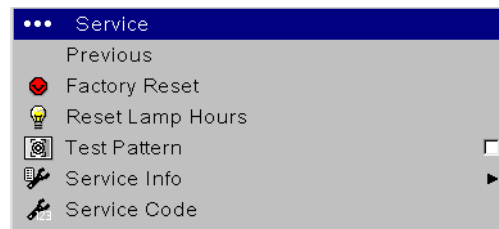

Service menu

Maintenance

Cleaning the lens

- 1 Apply a non-abrasive camera lens cleaner to a soft, dry cloth.

Avoid using an excessive amount of cleaner, and don't apply the cleaner directly to the lens. Abrasive cleaners, solvents or other harsh chemicals might scratch the lens.
- 2 Lightly wipe the cleaning cloth over the lens in a circular motion. If you don't intend to use the projector immediately, replace the lens cap.

Cleaning the lamp filter screens

In dirty or dusty environments, the dust filter screens on and around the lamp module can become clogged, causing high temperatures inside the lamp module. These high temperatures can impact lamp performance and operating life. Routine maintenance to remove dust and dirt from the screens lowers the lamp operating temperature and prolongs lamp life. To maximize lamp life you will need to clean the screens every 250 hours. Lamp screen maintenance may need to occur more often than 250 hours depending on your installation/use environment.

- 1 Remove the lamp module. Refer to “Replacing the projection lamp” on page 27 for instructions.
- 2 Examine the dust filter screens on the lamp module and in the lamp housing area. If necessary, use a vacuum cleaner set on low power to clean the screens. Be careful not to disturb any internal components when cleaning the screens.
- 3 Replace the lamp module.

Using the security lock

The projector has a security lock for use with a cable lock system. Refer to the information that came with the lock for instructions on how to use it.

Replacing the projection lamp

The lamp hour timer in the Service Info menu counts the number of hours the lamp has been in use. Twenty hours before the specified end of the lamp's life, the message "Replace lamp" briefly appears on the screen at each startup. When the expected lamp life has been reached, the Lamp indicator icon lights red.

NOTE: You can order new lamp housings from www.infocus.com (in select areas), your retailer or your dealer. Use only a replacement lamp with the same type and rating as the original lamp.

- 1 Turn off the projector and unplug the power cable.
- 2 Wait 60 minutes to allow the projector to cool thoroughly.
- 3 Turn the projector upside down and loosen the captive screw on the lamp door. The lamp door is part of the lamp housing.

- 4 Insert the screwdriver in the tab on the lamp door and pry the door up.

WARNINGS:

- To avoid burns, allow the projector to cool for at least 60 minutes before you replace the lamp.
- Unplug the power cord before replacing the lamp.
- Do not drop the lamp module. The glass may shatter and cause injury.
- Do not touch the glass lamp screen. Fingerprints can obscure projection sharpness.

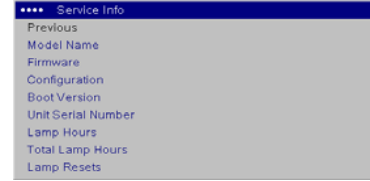

Service Info menu

turn off and unplug
the projector

wait 60 minutes

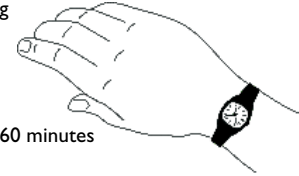

loosen the screw on lamp door



pry the lamp door off



- Be extremely careful when removing the lamp housing. In the unlikely event that the lamp ruptures, small glass fragments may be generated. The lamp module is designed to contain most of these fragments, but use caution when removing it. Before replacing a ruptured lamp, clean the lamp compartment and dispose of cleaning materials. Wash hands after lamp replacement.
Hg – Lamp contains mercury. Manage in accordance with local disposal laws. See www.lamprecycle.org.
- 5 Carefully remove the lamp housing. Dispose of the lamp in an environmentally proper manner.
 - 6 Install the new lamp housing. Be careful to attach the connector on the lamp housing to the connector inside the projector. These connectors are located near the leveling foot.
 - 7 Tighten all three screws.
 - 8 Plug in the power cable then press the **Power** button to turn the projector back on, then reset the lamp hour timer.

Resetting the lamp timer

To reset the lamp timer, navigate to the **Settings>Service** menu and select **Reset Lamp Hours**.

remove lamp housing

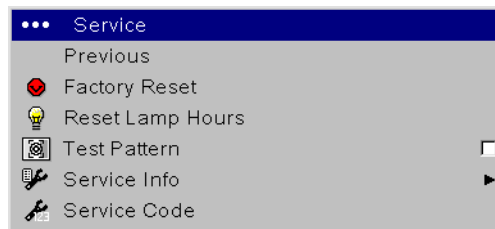

reset lamp time in Service menu

Appendix

Projected image size

Table 1:

Image Size, Width and Height for Lens at Maximum Image Size

Distance to Screen (feet/m)	Diagonal (inches/m)	Width (inches/m)	Height (inches/m)
4.9/1.5	40/1	32/8	24/6
7.4/2.3	60/1.5	48/1.2	36/9
9.9/3.0	80/2	64/1.6	48/1.2
12.3/3.8	100/2.5	80/2	60/1.5
18.5/5.6	150/3.8	120/3	90/2.3
32.8/10.0	266/6.8	213/5.4	160/4.1

Table 2:

Image Size, Width and Height for Lens at Minimum Image Size

Distance to Screen (feet/m)	Diagonal (inches/m)	Width (inches/m)	Height (inches/m)
4.9/1.5	31/8	25/6.4	19/4.8
7.4/2.3	47/1.2	38/1	28/7
9.9/3.0	63/1.6	50/1.3	38/8
12.3/3.8	79/2	63/1.6	47/1.2
18.5/5.6	118/3	94/2.4	71/1.4
32.8/10.0	209/5.3	167/4.2	125/3.3

NOTE: Visit our website for an interactive image size calculator.

INDEX

Numerics

1024x768 resolution 3

A

Advanced setting 22
Aspect Ratio 20, 25
Audio In connector 5, 8
Auto Power 23
Autosource 23

B

Blank screen 24
Brightness 7

C

cleaning the lamp filter screens 26
cleaning the lens 26
Color 20
Color Control 22
Color Space 22
Color Temperature 22
colors are incorrect 14
computer connections
 optional 5
 required 5
computer image
 optimize 18
 troubleshooting 10
connecting
 computer 5
 video device 8
connector panel 4
contacting InFocus 15
Contrast 7, 20
Custom key 18
customer service contact information 15

D

Display Messages 23
displaying, image 6

E

elevator foot 7

F

Factory Reset 25
focus 7
fuzzy image 11

I

image does not fit screen 13
image not centered 14
image not sharp 13
image not square 13
image reversed 14
image size matrix 29
image, displaying 6

K

keypad buttons 16
keystone 7, 20

L

- lamp
 - cleaning filter screens 26
- lamp replacement 27
- Lamp Reset 25
- lamp won't turn on 14, 15
- Language 25
- laptop
 - connecting 5
 - external video port 6
- LED 9
- lens, cleaning 26
- leveling foot 7
- lock, security 26
- Low Power 23

M

- Macintosh troubleshooting 11
- Main menu 19
- menu system 19

N

- no computer image 10
- no startup screen 10

O

- only startup screen appears 10
- onscreen menus 19
- Overscan 22

P

- PC Screen Saver 24
- Picture menu 20
- Position 22
- power cable 5, 8
- Power Save 9, 24
- Power-up Source 23
- presentation features 18
- projected image sizes 29
- projector
 - adjusting the height 7
 - connector panel 4
 - customizing 18
 - positioning 7
 - registering 3
 - safety considerations 2
 - shutdown 9
 - troubleshooting problems 9

R

- Rear 23
- remote control 17
- replacing the lamp 27
- Reset 25
- resetting the lamp timer 28
- resolution 3

S

- Screen Save 9, 24
- security lock 26
- Service 25
- Settings menu 23
- Sharpness 22
- shutting down the projector 9
- Sources 23
- Startup Logo 24
- Sync Threshold Adjust 22

T

- Tint 20
- Tracking 22
- Troubleshooting 9
- Turning off the projector 9

U

- using the keypad buttons 16

V

- video connections 8
- video images, optimizing 18
- Video Standard 22

W

- White Peaking 22

X

- XGA 3

Z

- zoom 7