

This entire user's guide is available on the enclosed CD as an Adobe Acrobat pdf file in the following languages: English, French, German, Italian, Norwegian, Portuguese, Spanish, Russian, Japanese, Korean, Traditional Chinese, Simplified Chinese. Before using this projector, please read these instructions.

Le mode d'emploi complet est disponible sur le CD joint sous forme de fichier pdf d'Adobe Acrobat dans les langues suivantes : anglais, français, allemand, italien, norvégien, portugais, espagnol, russe, japonais, coréen, chinois traditionnel, chinois simplifié. Avant d'utiliser ce projecteur, veuillez lire ces instructions.

Die vollständige Benutzeranleitung ist auf der im Lieferumfang enthaltenen CD als Adobe Acrobat PDF-Datei in den folgenden Sprachen verfügbar: Englisch, Französisch, Deutsch, Italienisch, Norwegisch, Portugiesisch, Spanisch, Russisch, Japanisch, Koreanisch, Traditionelles Chinesisch und Vereinfachtes Chinesisch. Bitte lesen Sie diese Anweisungen vor der Verwendung des Projektors.

La presente guida è disponibile sul CD allegato, come file Adobe Acrobat pdf, nelle seguenti lingue: inglese, francese, tedesco, italiano, norvegese, portoghese, spagnolo, russo, giapponese, coreano, cinese tradizionale e cinese semplificato. Prima di usare questo proiettore, leggere le seguenti istruzioni.

Hele denne brukerhåndboken finnes på den vedlagte CD-en som en Adobe Acrobat pdf-fil på følgende språk: Engelsk, fransk, tysk, italiensk, norsk, portugisisk, spansk, russisk, japansk, koreansk, tradisjonell og forenklet kinesisk. Les disse anvisningene før projektoren tas i bruk.

Este guia do usuário completo está disponível no CD anexo, como um arquivo pdf do Adobe Acrobat nos seguintes idiomas: inglês, francês, alemão, italiano, norueguês, português, espanhol, russo, japonês, coreano, chinês tradicional, chinês simplificado. Antes de utilizar este projetor, leia estas instruções.

Este manual de uso está disponible en su totalidad en el CD incluido, como archivo pdf de Adobe Acrobat, en los siguientes idiomas: inglés, francés, alemán, italiano, noruego, portugués, español, ruso, japonés, coreano, chino tradicional, chino simplificado. Antes de usar el proyector, lea estas instrucciones.

Данное руководство пользователя в полном объеме представлено на прилагаемом компакт-диске в виде pdf-файла Adobe Acrobat на следующих языках: английском, французском, немецком, итальянском, норвежском, португальском, испанском, русском, японском, корейском, традиционном и упрощенном китайском. Перед использованием проектора, прочитайте данные инструкции.

このユーザーズガイドは、プロジェクタに付属しているCDにAdobe AcrobatのPDFファイル形式として収録されています。次の言語のユーザーズガイドをご利用いただけます。英語、フランス語、ドイツ語、イタリア語、ノルウェー語、ポルトガル語、スペイン語、ロシア語、日本語、韓国語、簡体中国語、繁体中国語。このプロジェクタを使用する前に、ユーザーズガイドを必ずお読みください。

附带的 CD 上有 Adobe Acrobat pdf 格式的整本《使用者指南》，包括下列各种语言版本：英文、法文、德文、意大利文、挪威文、葡萄牙文、西班牙文、俄文、日文、韩文、繁体中文、简体中文。请在使用投影机之前，先阅读这些说明。

所附的光碟片上，有 **Adobe Acrobat (PDF)** 格式的這本《使用者手冊》；所提供的不同語言版本包括：英文、法文、德文、義大利文、挪威文、葡萄牙文、西班牙文、俄文、日文、韓文、中文繁體、以及中文簡體。開始使用本投影機之前，請先詳細閱讀這些說明。

동봉된 CD에는 Adobe Acrobat pdf 파일 형식의 사용 설명서가 영어, 프랑스어, 독일어, 이탈리아어, 노르웨이어, 포르투갈어, 스페인어, 러시아어, 일본어, 한국어, 중국어(번체 및 간체)로 제공됩니다. 이 프로젝터를 사용하기 전에 다음 지침을 읽으십시오.

Declaration of Conformity

Manufacturer: InFocus Corporation, 27500 SW Parkway Ave. Wilsonville, Oregon 97070 USA

European Office: Strawinskylaan 585, 1077 XX Amsterdam, The Netherlands

We declare under our sole responsibility that the projector conforms to the following directives and norms:

EMC Directive 89/336/EEC, Amended by 93/68/EEC

EMC: EN 55022

EN 55024

EN 61000-3-2

EN 61000-3-3

Low Voltage Directive 73/23/EEC, Amended by 93/68/EEC

Safety: EN 60950: 2000

July, 2002

Trademarks

Apple, Macintosh, and PowerBook are trademarks or registered trademarks of Apple Computer, Inc. IBM is a trademark or registered trademark of International Business Machines, Inc. Microsoft, PowerPoint, and Windows are trademarks or registered trademarks of Microsoft Corporation. Adobe and Acrobat are trademarks or registered trademarks of Adobe Systems Incorporated. Digital Light Processing is a trademark or registered trademark of Texas Instruments. InFocus and LP are trademarks or registered trademarks of InFocus Corporation.

FCC Warning

This equipment has been tested and found to comply with the limits for a Class A digital device, pursuant to part 15 of the FCC Rules. These limits are designed to provide reasonable protection against harmful interference when the equipment is operated in a commercial environment. This equipment generates, uses, and can radiate radio frequency energy and, if not installed and used in accordance with the instruction manual, may cause harmful interference to radio communications. Operation of this equipment in a residential area is likely to cause harmful interference in which case the user will be required to correct the interference at his own expense.

Canada

This Class A digital apparatus complies with Canadian ICES-003.

Cet appareil numérique de la classe A est conforme à la norme NMB-003 du Canada.

Remote Control Warning

Laser radiation class II product; wavelength 650nm; maximum output 1mW. Remote control complies with applicable requirements of 21 CFR 1040.10 and 1040.11.

Remote control complies with applicable requirements of EN 60 825-1: 1994 +A11.

**Do not look into the laser beam emitted
from the top of the remote control.**



Table of Contents

Introduction	5
Connecting a computer	6
Required computer connections	6
Displaying a computer image	7
First-time projector use with Windows 98	8
Adjusting the image	10
Connecting a video device	11
Displaying a video image	12
Shutting down the projector	14
Troubleshooting your setup	14
Using the keypad buttons	22
Using the remote control	23
Using the audio	24
Optimizing computer images	25
Presentation features	25
Optimizing video images	26
Customizing the projector	26
Using the menus	27
Picture menu	28
Settings menu	31
Maintenance	34
Cleaning the lens	34
Replacing the projection lamp	35
Appendix	37
Accessories	37
Red LED Behavior and Projector Errors	38

If you are experienced in setting up presentation systems, use the *Quick Set Up* card that was included in the box. For complete details on connecting and operating the projector, refer to this User's Guide. Electronic versions of this User's Guide in multiple languages are available on the included CD and on our website.

The website also has technical specifications (an interactive image size calculator, laptop activation commands, connector pin outs, a glossary, the product data sheet), a web store to buy accessories, and a page for online registration. See the inside of the back cover for a list of all contact numbers and relevant web addresses.

Important Operating Considerations

Do not place the projector on a tablecloth or other soft covering that may block the vents. Intake vents are placed along the left, front and back sides of the projector. Exhaust vents are placed along the right side of the projector. In the unlikely event that the lamp ruptures, discard any edible items and thoroughly clean the area along the right side of the projector.

Do not place objects in the area along the right side of the projector

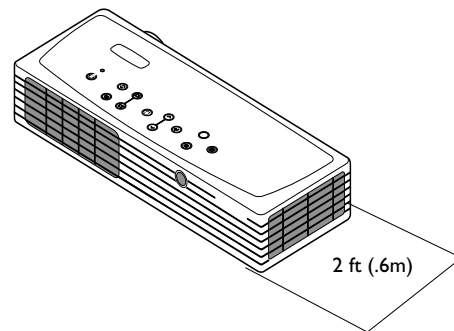

Introduction

Your new digital projector packs great performance into a shape and size customized for the mobile professional. It fits comfortably in your laptop bag then transitions easily into your presentation environment. It is easy to connect, easy to use, and easy to maintain.

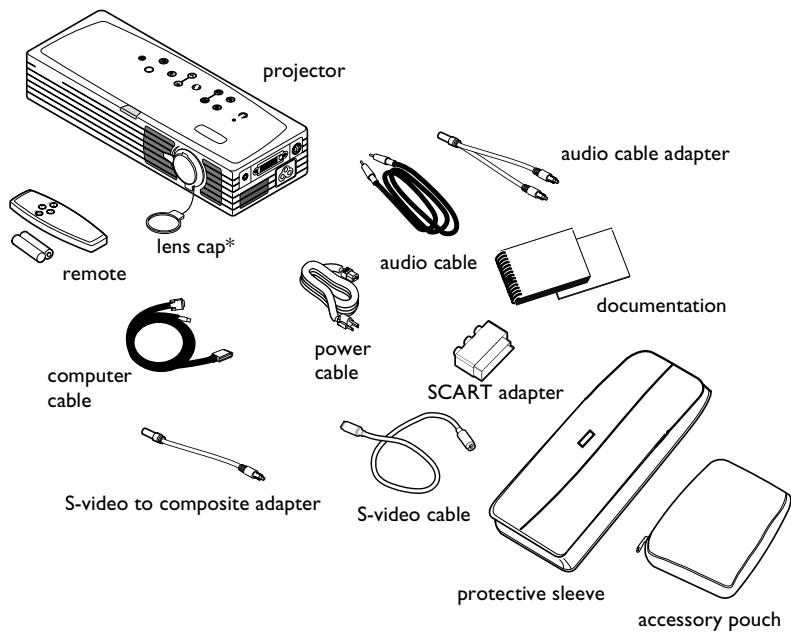

* the lens cap with tether ships in the accessory pouch. Insert the tether into the small hole under the lens when you unpack your projector.

Projector components and features

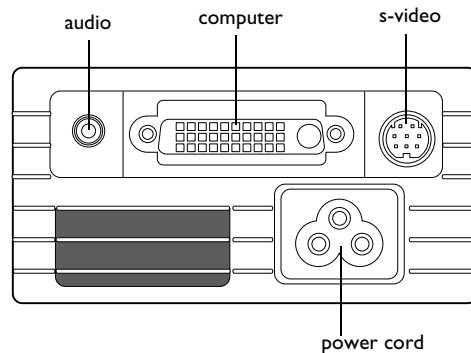
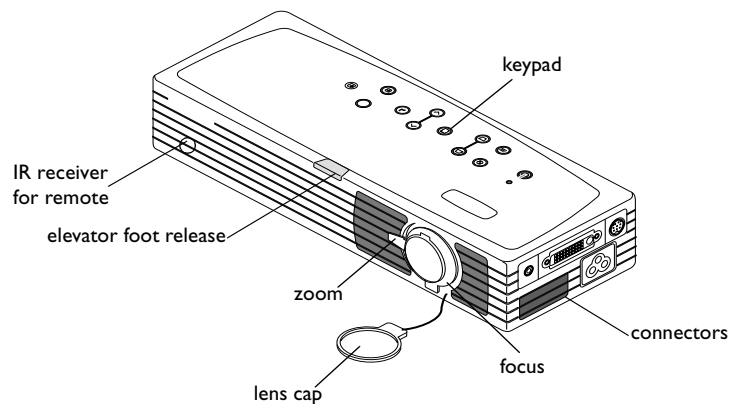

Connecting a computer

Required computer connections

Connect the black end of the computer cable to the **Computer in** connector on the projector. Connect the blue end to the video (VGA) port on your computer. If you are using a desktop computer with a single VGA port, you first need to disconnect the monitor from that computer's video port.

connect computer cable

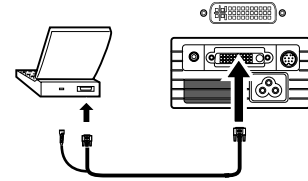

Connect the black power cable to the connector on the side of the projector and to your electrical outlet.

connect power cable

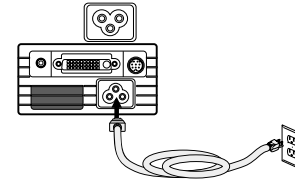

The Power LED on the projector's keypad turns solid green and the fans start to run.

NOTE: Always use the power cable that shipped with the projector.

Optional computer connections

To advance slides in a PowerPoint™ presentation using the remote, plug the USB connector on the computer cable into the USB mouse connector on your computer. USB drivers must be installed to use the USB feature. For more information, see page 9.

connect USB portion of computer cable

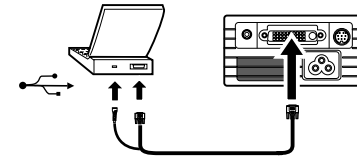

To have sound with your presentation, connect the audio cable to your computer and to the computer **Audio In** connector on the projector.

connect audio cable

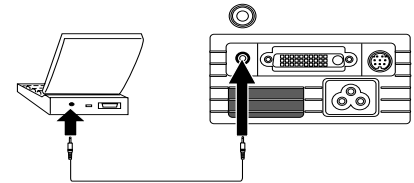

Displaying a computer image

Remove the lens cap.

remove lens cap

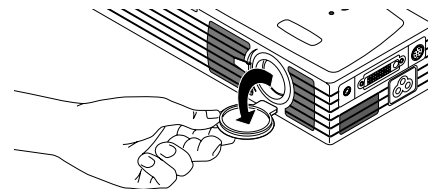

Press the **Power** button on the top of the projector.

The LED flashes green. When the lamp comes on, the startup screen is displayed and the LED is steady green. It can take a minute for the image to achieve full brightness.

press Power

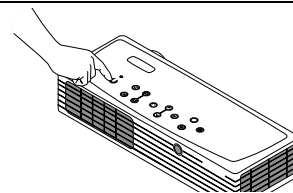

? No startup screen? Get help on page 15.

Turn on your computer.

turn on computer



The computer's image should appear on the projection screen. If it doesn't, press the **Source** button on the projector's keypad.

Make sure your laptop's external video port is active.

Many laptops do not automatically turn on their external video port when a projector is connected. Refer to your computer's documentation to learn the activation commands specific for your computer. For example, some laptops use a key combination of FN + F5 to turn the external display on and off.

activate laptop's external port



auto image

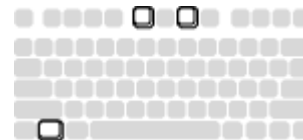

? No computer image? Try pressing the **Auto Image** button on the keypad. Get help on page 16.

First-time projector use with Windows 98

The first time you connect a computer running Windows 98 to the projector, the computer recognizes the projector as “new hardware” and the Add New Hardware Wizard appears. Follow these instructions to use the Wizard to load the correct driver (which was installed with your Windows operating system).

If you are running Windows 2000, Windows ME, or Windows XP, skip these steps and go to “Adjusting the image” on page 10.

a Click **Next** to begin searching for the driver.

b Make sure “Search for the best driver” is selected, then click **Next**.

c Uncheck any checked boxes, then click **Next**. Windows automatically locates the driver. If this driver has been removed, reload the driver using your Windows operating system CD.

d When Windows finds the driver, you are ready to install it. Click **Next**.

a



b

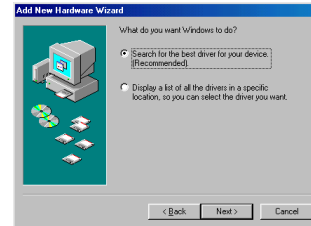

c



d

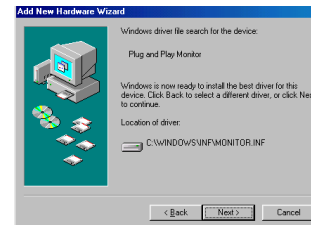

Skip this page if you did not connect the USB portion of the computer cable. The USB connection enables slide advance during presentations and projector control software.

For Windows 98:

- If you connected the USB cable, the Add New Hardware Wizard appears again. Drivers must be installed to use the USB functionality.
- **The Wizard launches three times.**

The first time it detects a USB Composite Device.

The second time a USB Human Interface Device (for the keyboard).

The third time it detects a USB Human Interface Device (for the mouse).

For Windows 2000, Windows ME, and Windows XP:

- The USB drivers are automatically installed.

Adjusting the image

Adjust the height of the projector, if necessary, by pressing the release button to extend the elevator foot.

Position the projector the desired distance from the screen at a 90 degree angle to the screen.

See page 38 for a table listing screen sizes and distances.

Adjust the zoom tab or the focus dial by rotating them until the desired image size and sharpness are produced.

If the image is not square, adjust the keystone by using the buttons on the keypad.

Press the upper **Keystone** button to reduce the upper part of the image, and press the lower **Keystone** button to reduce the lower part.

Adjust the Contrast or Brightness in the Picture menu.

See page 27 for help with the menus.

adjust height

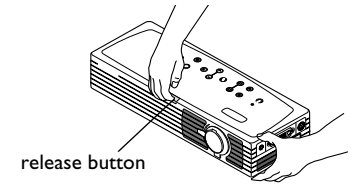

adjust distance

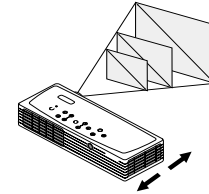

adjust zoom and focus

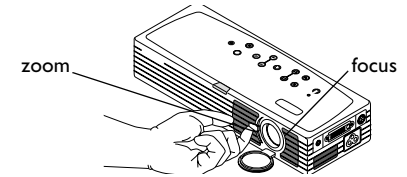

adjust keystone

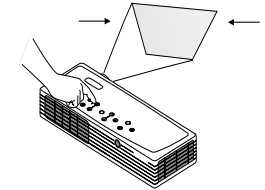

adjust Contrast or Brightness

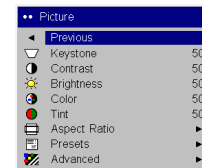

Connecting a video device

Standard video connections

Plug the S-video cable's connector into the S-video-out connector on the video device. Plug the other connector into the **S-Video** connector on the projector.

Plug the white connector of the audio adapter into the left audio out connector on the video device and plug the red connector into the right audio out connector on the video device.

Plug the audio cable into the other end of the audio cable adapter and into the **audio in** connector on the projector.

connect S-video cable and audio cable and adapter

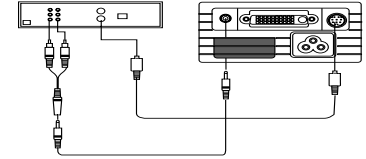

Connect the black power cable to the connector on the side of the projector and to your electrical outlet. The Power LED on the keypad turns solid green and the fans start to run.

NOTE: Always use the power cable that shipped with the projector.

connect power cable

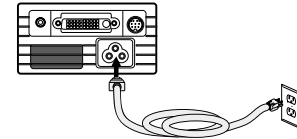

Optional video connections

If the video device uses a composite video connector, plug a composite video cable (sold separately) into the composite connector on the video device and into the S-video adapter. Plug the S-video adapter into the **S-video** connector on the projector. Use the audio cables as described above.

connect composite video cable and adapter and audio cable and adapter

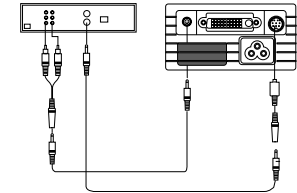

Displaying a video image

Remove the lens cap.

remove lens cap

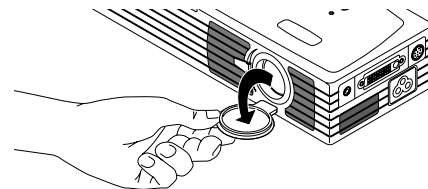

Press the **Power** button on the top of the projector.

The LED flashes green. When the lamp comes on, the startup screen is displayed and the LED is steady green. It can take a minute for the image to achieve full brightness.

? **No startup screen?** Get help on page 15.

press Power

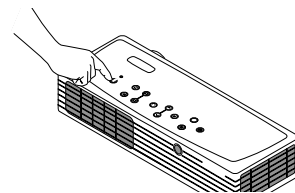

Plug in and turn on the video device.

? **No video image?** Try pressing the **Source** or **Auto Image** button on the keypad. Get help on page 15.

turn on video device

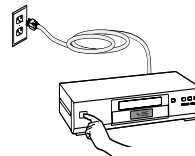

Adjust the height of the projector by pressing the release button to extend the elevator foot.

adjust height

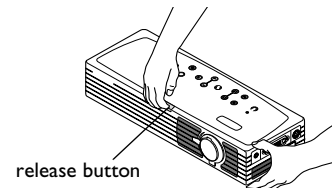

Position the projector the desired distance from the screen at a 90 degree angle to the screen. See page 38 for a table listing screen sizes and distances to the screen.

adjust distance

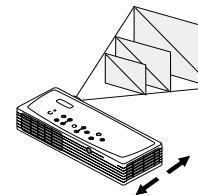

Adjust the zoom using the tab or the focus using the dial by rotating them until the desired image size and sharpness are produced.

adjust zoom and focus

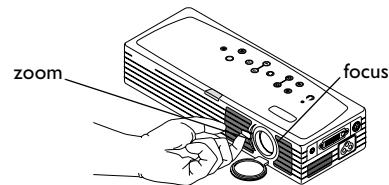

If the image is not square, adjust the keystone using the buttons on the keypad. Press the upper **Keystone** button to reduce the upper part of the image, and press the lower **Keystone** button to reduce the lower part.

adjust keystone

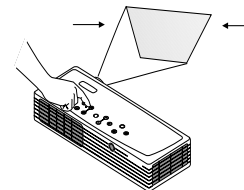

Adjust the volume on the keypad.

adjust volume

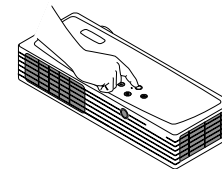

Adjust the **Contrast**, **Brightness**, **Color**, or **Tint** in the Picture menu.

See page 27 for help with the menus.

adjust Picture menu

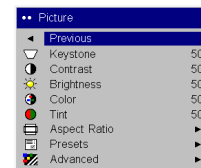

Shutting down the projector

By default, the projector automatically displays a blank screen after no active source is detected for 30 minutes. This blank screen helps preserve the life of the projector. The image returns when an active source is detected or a remote or keypad button is pressed.

Screen Save

You can make the blank screen appear after a different time interval using the **Settings>System** menu. See page 32. There are six time options, ranging from five minutes to 30 minutes with five minute intervals.

Power Save

The projector also has a Power Save feature that, when activated, automatically turns the lamp off after no signals are detected for 20 minutes. After 10 additional minutes with no signal, the projector powers down. If an active signal is received before the projector powers down, the image is displayed. You must press the Power button to display an image after 30 minutes have passed. When Power Save is enabled, Screen Save is disabled. See page 31.

Turning off the projector

To turn off the projector, press the **power** button and verify that you want to turn the projector off by pressing the power button again within 3 seconds. You can cancel the shutdown by not pressing the **power** button a second time. The lamp turns off and the LED blinks green for 1 minute. When the lamp has cooled, the LED lights green. Unplug the power cable to completely power off the projector.

Troubleshooting your setup

If your image appears correctly on the screen, skip to the next section (page 23). If it does not, troubleshoot the setup.



The LED on top of the projector indicate the state of the projector and can help you troubleshoot.

Table 1: LED behavior and meaning

LED color/behavior	Meaning
solid green	The projector is plugged in, or the projector has been turned on and the software has initialized or the projector has been turned off.
blinking green	The power button has been pressed and the software is initializing, or the projector is powering down.
blinking red see page 38 for more information	A fan or lamp failure has occurred. Make sure the vents aren't blocked (see page 20). Turn off the projector and wait one minute, then turn the projector on again. If the Change Lamp message appears, replace the lamp and reset the lamp timer. Contact Technical Support if the problem persists.
solid red	An unidentifiable error: please contact Technical Support.

The following tables show common problems. In some cases, more than one possible solution is provided. Try the solutions in the order they are presented. When the problem is solved, you can skip the additional solutions.

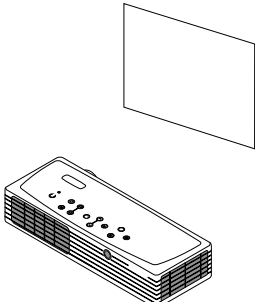
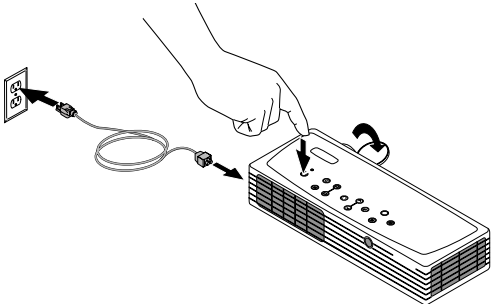
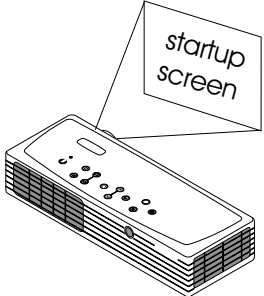
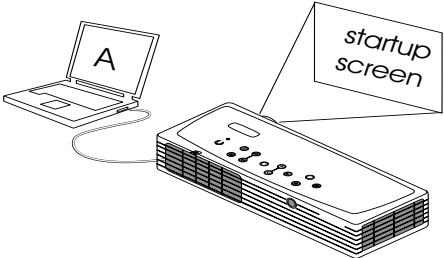
Source Troubleshooting

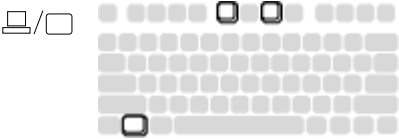
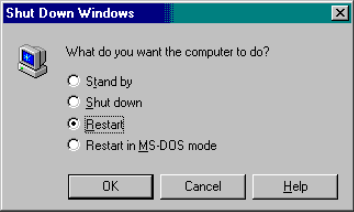
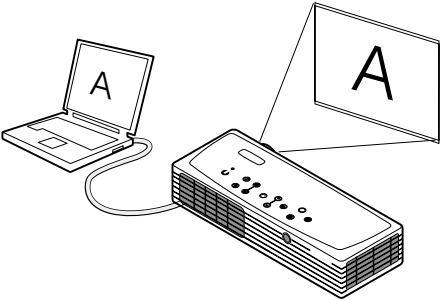
Problem	Solution	Result
<p data-bbox="48 215 256 242">No startup screen</p> 	<p data-bbox="664 153 1121 207">Plug power cable in and press the power button. Remove lens cap.</p> 	<p data-bbox="1189 215 1355 242">Correct image</p> 
<p data-bbox="48 575 371 601">Only startup screen appears</p> 	<p data-bbox="664 606 1013 666">Press the Source button  Activate laptop's external port</p> <p data-bbox="664 842 770 896">or restart laptop</p>  	<p data-bbox="1189 575 1499 601">Computer image projected</p> 

No computer image, just the words “Signal out of range”

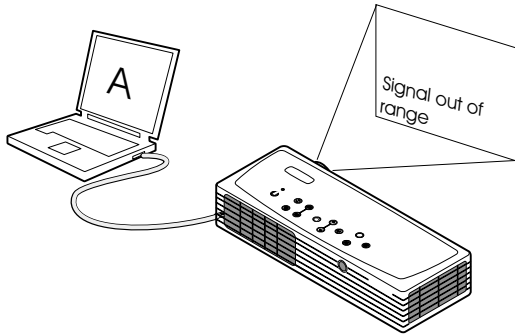

Adjust computer refresh rate in Control Panel>Display>Settings>Advanced>Adapter (location varies by operating system)

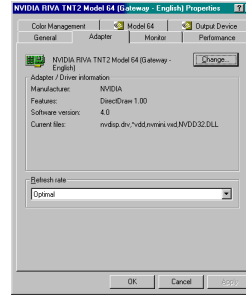

You may also need to set a different resolution on your computer, as shown on the following page

Computer image projected

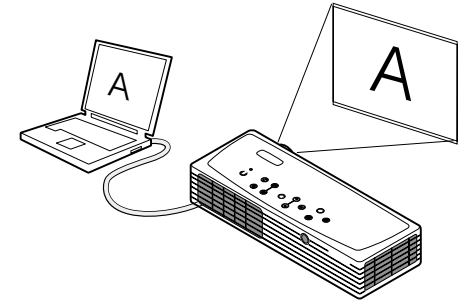
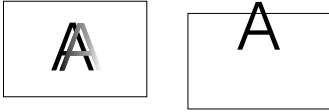

Image fuzzy or cropped



Set your computer's display resolution to the native resolution of the projector (Start>Settings>Control Panel>Display>Settings tab, select 1024x768)

For a laptop, disable laptop monitor or turn-on dual-display mode

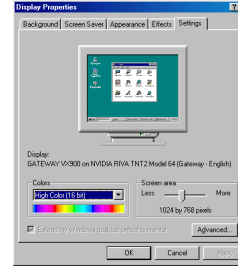
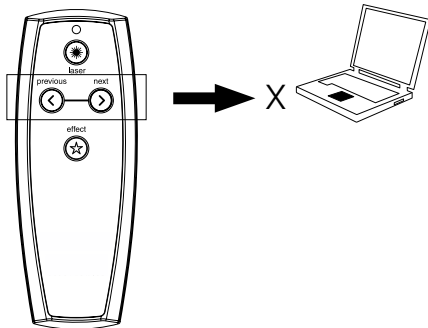

Image clear and not cropped



Remote control not advancing PowerPoint slides



**Connect computer cable (page 6), then load USB drivers, if needed (page 8)
Check batteries in remote**

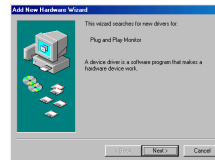
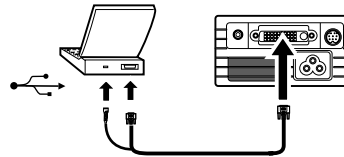

**Remote advances slides.
See page 23 for information on the remote**

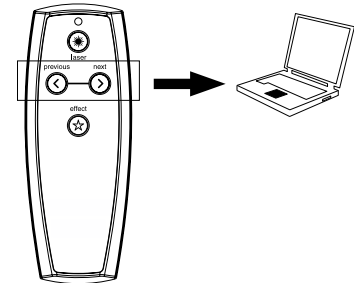

Projector troubleshooting







Problem	Solution	Result
<p>Image not square</p> 	<p>Adjust keystone on keypad</p> 	<p>Square image</p> 
<p>Edges of video image distorted</p> 	<p>Turn Overscan on in the Picture>Advanced menu</p> 	<p>Correct image</p> 
<p>Image not sharp</p> 	<p>Adjust Sharpness in the Picture>Advanced menu</p> 	<p>Correct image</p> 

Image does not fit 16:9 screen

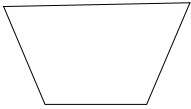
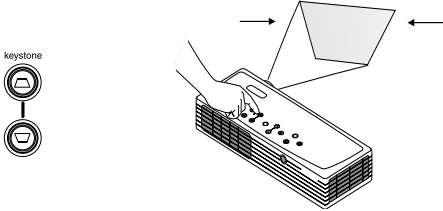

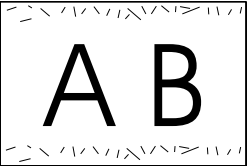
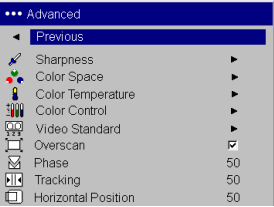
Change aspect ratio to 16:9 in
Picture>Aspect ratio menu

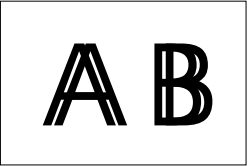

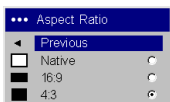
Correct image



Image reversed left to right



Turn off Rear in Settings>System menu

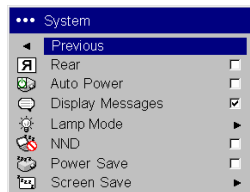

Correct image



Video image “torn” and fragmented

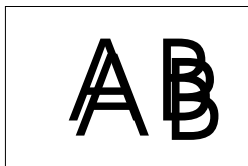

Change Video Standard in
Picture>Advanced menu

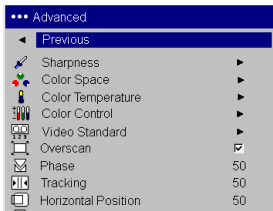

Correct image



Projected colors don't match source

~~COLOR~~

Adjust color temperature, color space, color control, brightness, and contrast in the Picture and Advanced menus. Also, adjust color and tint (video sources only).

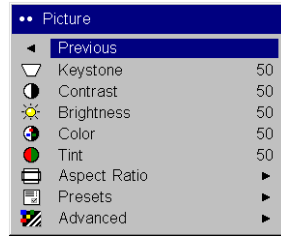

Correct image

COLOR

Lamp won't turn on, LED blinking red (page 14)

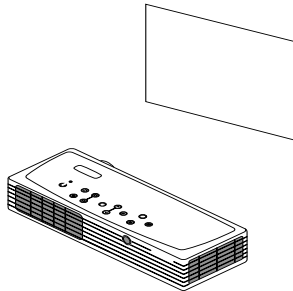
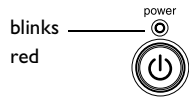

Make sure vents aren't blocked; allow projector to cool for one minute

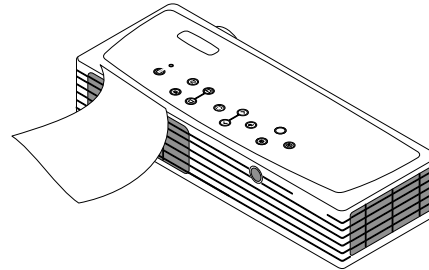

Unplug projector; wait one minute; plug in projector and turn it on: lamp lights

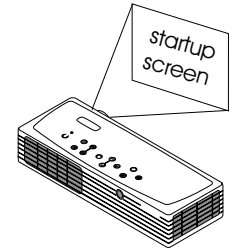

Lamp won't turn on, LED blinking red (page 14)

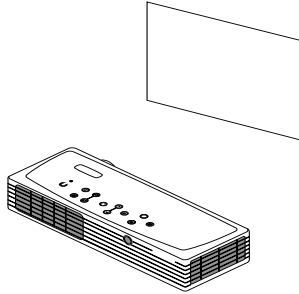
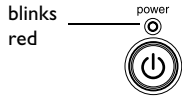

Lamp must be replaced (page 35)

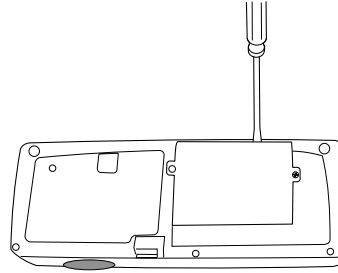

Lamp turns on

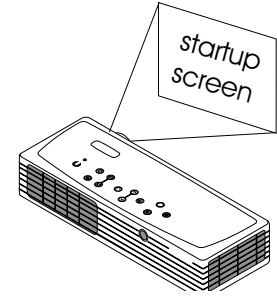
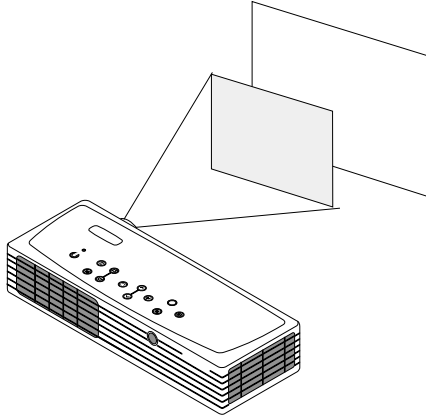
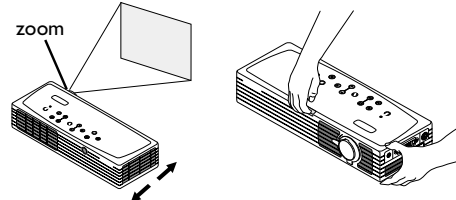

Image not centered on screen



Move projector, adjust zoom, adjust height



Adjust horizontal or vertical position in Picture>Advanced menu

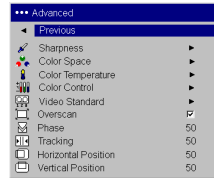

Correct image

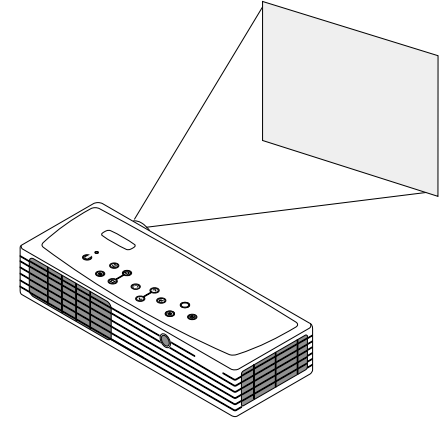

This product is backed by a limited two-year warranty. An extended warranty plan may be purchased from your dealer. When sending the projector in for repair, we recommend shipping the unit in its original packing material, or having a professional packaging company pack the unit for shipping.

An optional ATA shipping case is available for purchase that provides adequate protection for shipping. Please insure your shipment for its full value.

Using the keypad buttons

Most buttons are described in detail in other sections, but here is an overview of their functions:

power—turns the projector on (page 7) and off (page 14).

menu—displays the on-screen menus (page 27).

select—confirms choices made in the menus (page 27).

up/down arrows—navigates to and adjusts settings in the menus (page 27).

auto image—resets the projector to the source.

presets—cycles through the available preset settings (page 29).

keystone—adjusts squareness of the image (page 10).

volume—adjusts sound (page 24).

source—changes the active source between computer and video.

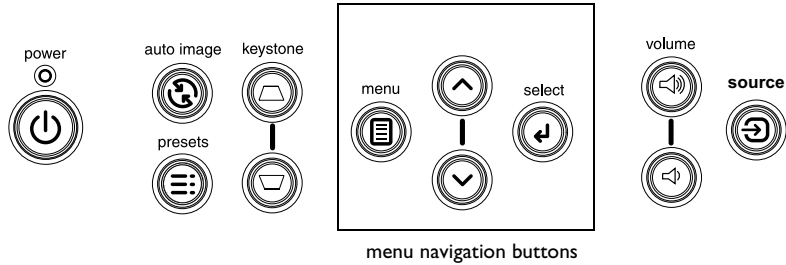

Using the remote control

The remote uses two (2) provided AAA batteries. They are easily installed by sliding the cover off the remote's back, aligning the + and - ends of the batteries, sliding them into place, and then replacing the cover.

To operate, point the remote at the projection screen or at the projector (not at the computer). The range of optimum operation is about 30 feet (9.14m).

To use the laser pointer, press and hold the **Laser** button. The laser turns off when the button is released, or times out after two (2) minutes of continuous operation.

WARNING: Do not look into the laser beam emitted from the top of the remote control.

Previous and Next buttons allow you to navigate through your PowerPoint presentation while in Slide Show mode. Connect the USB connector on the computer cable to your computer to use these buttons. When you do this for the first time, the Add New Hardware wizard may appear. See page 8 for details on loading the correct USB drivers.

The effect button allows you to invoke a user-definable action, such as freeze or blank the screen (see page 32 to learn to program this button).

Troubleshooting the remote

- Make sure the batteries are installed in the proper orientation and are not dead. When battery power is adequate, the LED at the top of the remote lights when any button is pressed.
- Make sure you're pointing the remote at the projector, not the computer, and are within the remote range of 30 feet (9.14m).
- If you are trying to advance PowerPoint slides, make sure the USB cable is connected (page 6) and the correct drivers are installed (page 8).

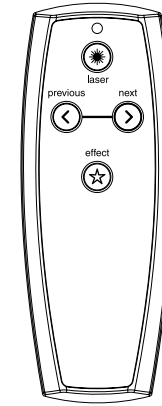

Using the audio

To play sound from the projector, connect your source to the Audio In connector on the projector.

To adjust the volume, use the buttons on the keypad.

Troubleshooting audio

If there is no sound, check the following:

- Make sure the audio cable is connected.
- Make sure mute isn't active (used with the **Effect** key).
- Make sure the volume is turned up enough. Press the volume button on the keypad.
- Adjust the audio source.
- If playing a video, make sure the playback has not been paused.

connect audio cable

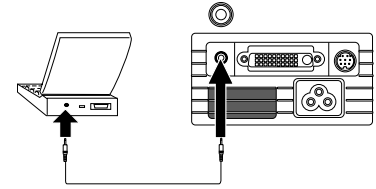

computer: audio cable

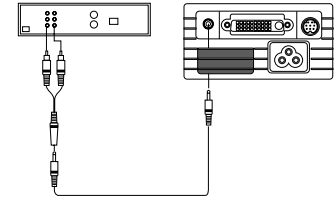

video: audio cable and adapter

adjust volume

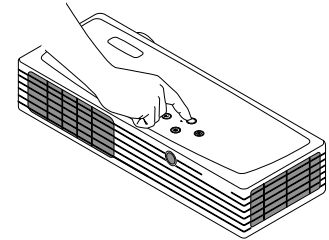
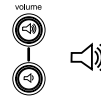

Optimizing computer images

After your computer is connected properly and the computer's image is on the screen, you can optimize the image using the onscreen menus. For general information on using the menus, see page 27.

- Adjust the Keystone, Contrast, or Brightness in the Picture menu.
- Change the Aspect Ratio. Aspect Ratio is the ratio of the image width to image height. TV screens are usually 1.33:1, also known as 4:3. HDTV and most DVDs are 1.78:1, or 16:9. Choose the option that best fits your input source. See page 28 for details.
- Adjust the Color Space, Color Temperature, or Color Control in the Advanced menu.
- Adjust the Phase, Tracking, or Horizontal or Vertical position in the Advanced menu.
- Once you have optimized the image for a particular source, you can save the settings using Presets. This allows you to quickly recall these settings later. See page 29.

Presentation features

Several features are provided to make it easier to give presentations. The following is an overview, details are found in the menu section on page 27.

- The remote's **Effect** button allows you to assign various features to the key. The default effect is About, which displays information about the projector and current source. You can select from Blank, Mute, Aspect Ratio, Source, Auto Image, Freeze, Zoom, and About. See page 32 for details.
- The Freeze effect allows you to freeze the displayed image. This is useful if you want to make changes on your computer without your audience seeing them.
- The Startup Logo and Blank Screen menu options let you change the default startup screen to a black, white, or blue screen. See page 32.
- Two menu options, Power Save and Screen Save, are provided to automatically shut down the projector after several minutes of inactivity or display a black screen. This helps preserve lamp life. See page 31 and page 32.
- A Lamp Mode option is also available to let you optimize lamp brightness or lamp life. See page 31.

Optimizing video images

After the video device is connected properly and the image is on the screen, you can optimize the image using the onscreen menus. For general information regarding menu usage, see page 27.

- Adjust the Keystone, Contrast, Brightness, Color, or Tint in the Picture menu. See page 28.
- Change the Aspect ratio. Aspect ratio is the ratio of the image width to image height. TV screens are usually 1.33:1, also known as 4:3. HDTV and most DVDs are 1.78:1, or 16:9. Choose the option that best fits your input source. See page 28.
- Select a Sharpness setting in the Advanced menu. See page 30.
- Select a different Color Temperature, or use the Color Control to individually adjust the intensity of the red, green, and blue color. See page 30.
- Select a different Video Standard. Auto tries to determine the standard of the incoming video. Select a different standard if necessary. See page 30.
- Turn overscan on to remove noise around the video image. See page 30.
- Once you have optimized the image for a particular source, you can save the settings using Presets. This allows you to quickly recall these settings later. See page 29.

Customizing the projector

You can customize the projector for your specific setup and needs. See page 31 to page 33 for details on these features.

- For rear projection, turn Rear mode on in the **Settings>System** menu.
- Specify which source the projector checks first for active video during power-up.
- Specify the function of the Effect Key on the remote.
- Turn the projector's display messages on and off.
- Turn on power saving features.
- Specify blank screen colors and startup logos.
- Specify the menu language.
- Specify a lamp mode to optimize either brightness or lamp life.
- Prevent your computer from entering Screen Save mode.
- Save settings for the active source as a preset.

Using the menus

To open the menus, press the **Menu** button on the keypad. (The menus automatically close after 60 seconds if no buttons are pressed.) The Main menu appears. Use the arrow buttons to move up and down to highlight the desired submenu, then press the **Select** button.

To change a menu setting, highlight it, press **Select**, then use the up and down arrow buttons to adjust the value, select an option using radio buttons, or turn the feature on or off using check boxes. Press **Select** to confirm your changes. Use the arrows to navigate to another setting. When your adjustments are complete, navigate to Previous, then press **Select** to go to the previous menu; select Exit or press the **Menu** button at any time to close the menus.

Dots appear before the menu name. The number of dots indicate the menu's level, ranging from one (the Main menu) to four (the most nested menus).

The menus are grouped by usage:

- The Picture menu provides image adjustments.
- The Settings menu provides set-up type adjustments that are not changed often.
- The About menu provides a read-only display of information about the projector and source.

Certain menu items may be hidden until a particular source is connected. For example, Sharpness is only available for video sources and will be hidden when a computer source is active. Other menu items may be grayed out when they are not available. For example, Brightness is grayed out until an image is active.

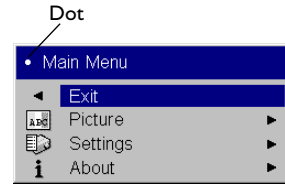

Main menu

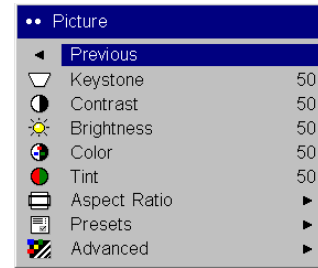
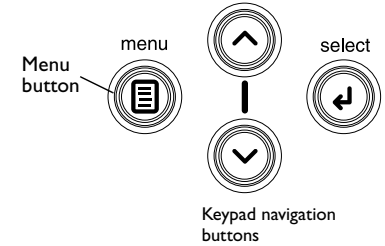

Picture menu

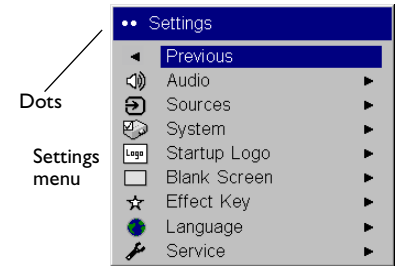

Settings menu

About menu

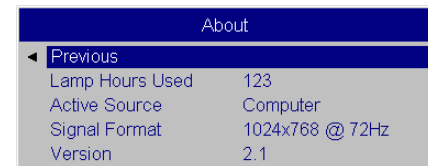

Picture menu

To adjust the following five settings, highlight the setting, press **Select**, use the up and down arrows to adjust the values, then press **Select** to confirm the changes.

Keystone: adjusts the image vertically and makes a squarer image. You can also adjust keystone from the keypad.

Contrast: controls the degree of difference between the lightest and darkest parts of the picture and changes the amount of black and white in the image.

Brightness: changes the intensity of the image.

Color: (video sources only) adjusts a video image from black and white to fully saturated color.

Tint: (NTSC video sources only) adjusts the red-green color balance in the image.

Aspect Ratio: Aspect ratio is the ratio of the image width to image height. TV screens are usually 1.33:1, also known as 4:3. HDTV and most DVDs are 1.78:1, or 16:9. The default is 4:3, which displays the input resized up or down to fill the display area.

Select Native to see the unmodified input with no resizing by the projector. Select 16:9 to watch enhanced widescreen DVDs.

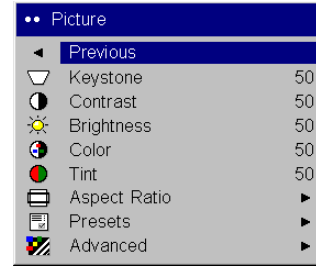

increasing keystone

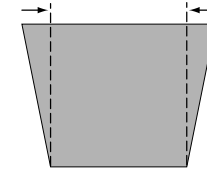

decreasing keystone

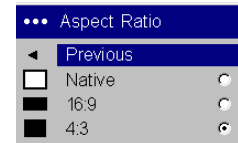
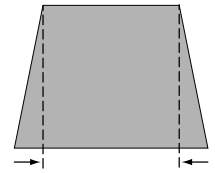

Aspect ratio

Presets: The provided Presets optimize the projector for displaying computer presentations, film images, and video images. (Film input is material originally captured on a film camera, like a movie; video input is material originally captured on a video camera, like a TV show or sporting event.) You can use the preset as a starting point, then further customize the settings for each source. The settings you customize are saved in the preset for each source. To restore the factory default settings, choose Factory Reset in the **Settings>Service** menu.

There are also three user-definable presets. To set a preset for the current source, adjust the image, select **Save Settings** in the Presets menu, then choose Save User 1, 2, or 3. You can recall these settings in the future by selecting the appropriate user presets.

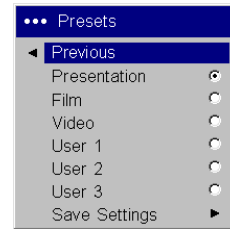

Presets

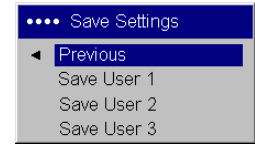

Save User Presets

Advanced menu

Sharpness: (video sources only) changes the clarity of the edges of a video image. Select a sharpness setting.

Color Space: (computer sources only) allows you to select a color space that has been specifically tuned for the input. When Auto is selected, the projector automatically determines the standard. To choose a different setting, turn off Auto, then choose either RGB, REC709 or REC601.

Color Temperature: changes the intensity of the colors. Select a listed setting.

Color Control: allows you to individually modify each color. Highlight the color, press **Select**, then use the arrows to adjust the value.

Video Standard: (video sources only) When it is set to Auto, the projector attempts to pick the video standard automatically based on the input signal it receives. (The video standard options may vary depending on your region of the world.) If the projector is unable to detect the correct standard, the colors may not look right or the image may appear “torn.” If this happens, manually select a video standard by selecting NTSC, PAL, or SECAM from the Video Standard menu.

Overscan: (video sources only) removes noise around the video image.

The following 4 options are for computer sources only.

Phase: adjusts the horizontal phase of a computer source.

Tracking: adjusts the vertical scan of a computer source.

Horizontal/Vertical Position: adjusts the position of a computer source.

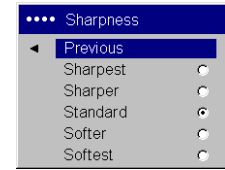
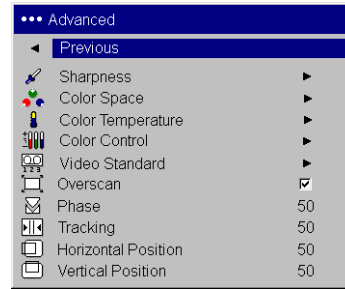

Sharpness

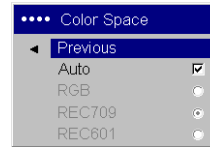

Color Space

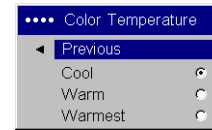

Color Temperature

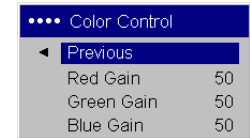

Color Control



Video Standard

Settings menu

Audio: allows volume adjustments. You can also adjust volume from the keypad.

Sources: allows you to assign a particular input to a specific source key when using certain optional remotes. Also allows selection of a default Power-up Source and enables or disables Autosource. When Autosource is not checked, the projector defaults to the source selected in Power-up Source. If no source is found, a blank screen displays. When Autosource is checked, Power-up Source determines which source the projector defaults to at power-up. If no signal is present, the projector checks the sources in order until a source is found or until power down.

Power-up Source: determines which source (computer or video) the projector checks first for active video during power-up.

System menu

Rear: reverses the image so you can project from behind a translucent screen.

Auto Power: When Auto Power is checked, the projector turns on when power is applied and turns off if a source becomes inactive.

Display Messages: displays status messages (such as “Searching” or “Mute”) in the lower-left corner of the screen.

Lamp Mode: allows you to optimize the lamp mode for your specific use. The default is High Bright, which maximizes the light output. Select Long Life to maximize lamp life and minimize fan noise, or Nominal to balance brightness, lamp life, and fan noise.

NND (Notebook No-Doze): prevents your notebook computer from going into Screen Save mode (functions only when the USB connector is plugged in).

Power Save: automatically turns the lamp off after no signals are detected for 20 minutes. After 10 additional minutes with no signal, the projector powers down. If an active signal is received before the projector powers down, the image will be displayed.



Audio

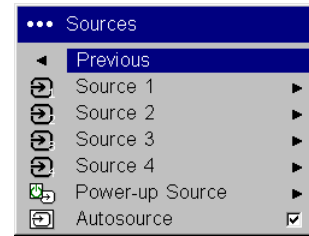

Sources

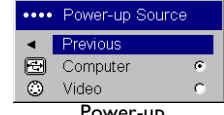
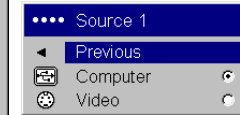

Power-up Source

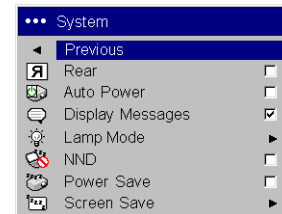

System menu

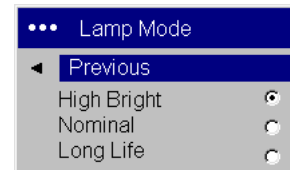

Lamp mode

Screen Save: automatically blanks the screen with a black color after no signals are detected for a preset number of minutes (the default is 30 minutes). The image returns when an active source is detected or a remote or keypad button is pressed. Screen Save is disabled when Power Save is enabled.

Startup Logo: allows you to display a blank Black, White, or Blue screen instead of the default screen at startup and when no source is detected.

Blank Screen: determines what color displays when no source is active.

Effect Key: allows you to assign a different function to the **Effect** button on the remote to quickly and easily use the effect. Only one effect can be enabled at a time. Highlight an effect and press **Select** to choose a different one.

Blank: shows an empty screen.

Mute: turns off all sound.

Aspect Ratio: sets the ratio of the image width to image height.

Source: cycles through the available sources.

Auto Image: causes sources to be reacquired.

Freeze: pauses the projected image.

Zoom: lets you magnify a part of the screen. This feature only works if you purchase an optional remote control with mouse buttons and cursor control. To use the Zoom effect, press **Effect**, then press the left button to zoom the image, press the right mouse decrease the magnification. You can use the cursor control to pan the image, displaying different parts of it (only if the image is magnified). To return to the original size and cancel Zoom, press the **Effect** button a second time.

About: is the default effect. It displays the About menu.

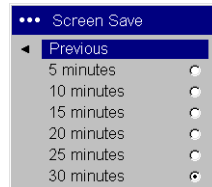

Screen Save

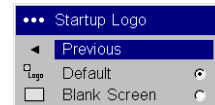

Startup logo

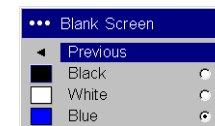

Blank Screen

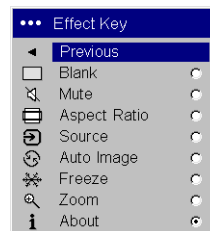

Effect Key

Language: allows you to select a language for the onscreen display of menus and messages.



Language

Service: to use these features, highlight them and press **Select**.

Factory Reset: restores all settings (except Lamp Hours) to their default after displaying a confirmation dialog box.

Lamp Reset: resets the lamp hours counter in the About menu to zero after displaying a confirmation dialog box. Do this only after changing the lamp.

Service Code: only used by authorized service personnel.

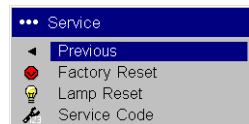

Service menu

Maintenance

Cleaning the lens

- 1 Apply a non-abrasive camera lens cleaner to a soft, dry cloth.

Avoid using an excessive amount of cleaner, and don't apply the cleaner directly to the lens. Abrasive cleaners, solvents or other harsh chemicals might scratch the lens.

- 2 Lightly wipe the cleaning cloth over the lens in a circular motion. If you don't intend to use the projector immediately, replace the lens cap.

clean the lens
with a soft dry cloth
and non-abrasive
cleaner

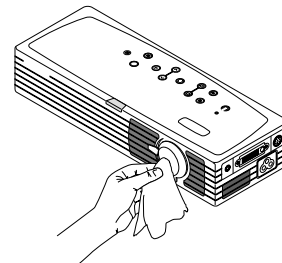

Replacing the projection lamp

The lamp hour timer in the About menu counts the number of hours the lamp has been in use. Fifty hours before the specified end of the lamp's life, the message "Change lamp" briefly appears on the screen at each startup. After 50 additional hours, the lamp will no longer light. You can order new lamp modules from your dealer. See "Accessories" on page 37 for information.

- 1 Turn off the projector and unplug the power cable.
- 2 Wait 60 minutes to allow the projector to cool thoroughly.

- 3 Turn the projector upside down and loosen the two screws on the lamp door. Pry the door straight up to disengage the power interrupt connector (located on the underside of the door) and remove the lamp door. Be sure to pry the door straight up, not at an angle, to avoid damaging the power interrupt connector.

NOTE: The projector will not turn on while the lamp door is removed.

- 4 Pull the pull tab on the lamp module up to release the catch.

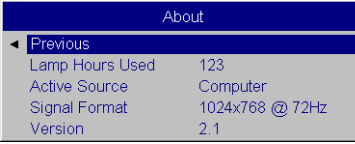

About	
◀ Previous	
Lamp Hours Used	123
Active Source	Computer
Signal Format	1024x768 @ 72Hz
Version	2.1

About menu

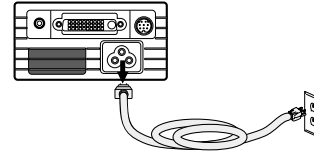

turn off and unplug
the projector

wait 60 minutes

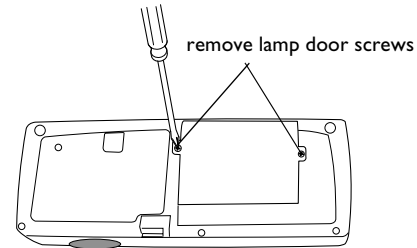

pry door off

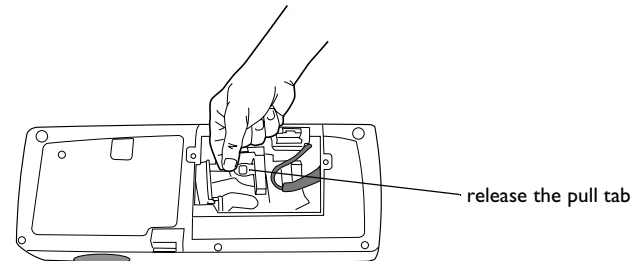
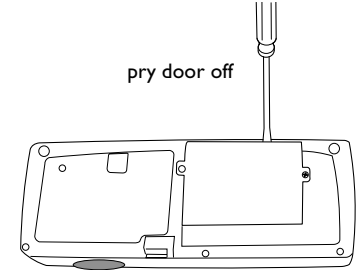

- 5 Pinch the lamp cable's connector tabs to release the catch while pulling firmly on the connector to unplug the lamp.

WARNINGS:

- To avoid burns, allow the projector to cool for at least 60 minutes before you replace the lamp.
- Do not drop the lamp module. The glass may shatter and cause injury.
- Do not touch the glass lamp screen. Fingerprints can obscure projection sharpness.
- Be extremely careful when removing the lamp housing. In the unlikely event that the lamp ruptures, small glass fragments may be generated. The lamp module is designed to contain most of these fragments, but use caution when removing it.

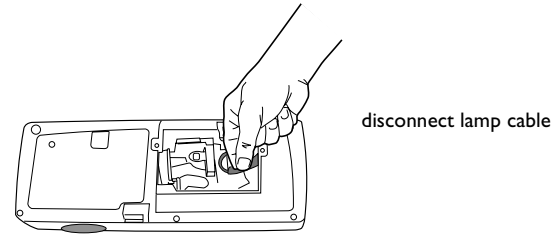

- 6 Carefully remove the lamp module. Note that the lens end of the module has a tab that connects in a slot in the bottom of the lamp cavity. You must pull upward with enough force to disconnect the tab from the slot. Dispose of the lamp in an environmentally proper manner.

- 7 Install the new lamp module. Slide the new module straight down over the tunnel/hood, align the tab with the slot, then press to connect.

- 8 Re-latch the pull tab while pressing down on the lamp module.

- 9 Re-plug in the lamp cable.

- 10 Replace the lamp door by aligning the connector on the back of the door with the projector and replacing the two lamp door screws.

- 11 Plug in the power cable, then press the **Power** button to turn the projector back on. Reset the lamp hour timer by simultaneously holding down the two **Volume** keys on the projector's keypad for 10 seconds. At that point the LED will turn green and you can power on the projector. You can also navigate to the **Settings>Service** menu and select **Lamp Reset** to reset the lamp timer.

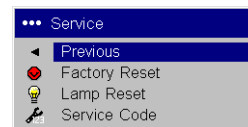
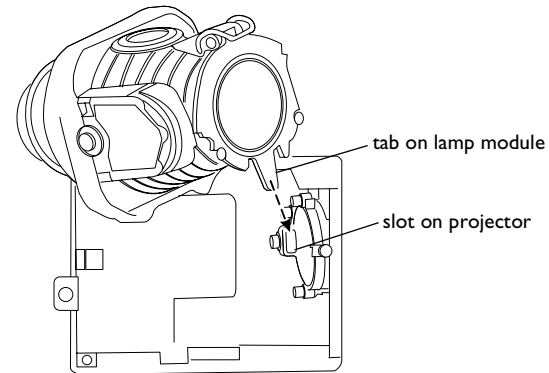

reset lamp time in Service menu

Appendix

Accessories

Standard Accessories (ship with the projector)

	Part Number
Protective Sleeve	110-0694-xx
Accessory Pouch	110-0693-xx
Shipping Box (with packaging)	110-0696-xx
Computer Cable 6.6 ft (2 m)	SP-DVI-A
S-Video Cable 6 ft (1.8 m)	210-0125-xx
S-video to RCA Adapter	515-0027-xx
Audio Cable 6 ft (1.8 m)	210-0118-xx
Audio Cable Adapter	210-0177-xx
Power Cable (US) 10 ft (3m)	210-0255-xx
Power Cable (European) 10 ft (3m)	210-0254-xx
Presenter Remote	590-0562-xx
Projection Lamp Module (included in projector)	SP-LAMP-013
Quick Setup card	009-0791-xx
User's Guide with CD	010-0457-xx
Technical Support Contacts Card	009-0658-xx
Safety Card	009-0659-xx
Color-coded Cable Ties, 3 set	SP-CABLETIES
SCART Adapter	301130B

Optional Accessories

Part Number

ATA Shipping Case	CA-ATA-016
Soft Carry Case	CA-C220
Digital Computer Cable 6 ft (1.8 m)	SP-DVI-D
50" Diagonal Screen (portable)	A650
60" Diagonal Screen (portable)	HW-DLXSCRN
84" Diagonal Wall/Ceiling Mounted Screen	HW-WALLSCR84
Portable Projector Stand	SP-STND
Replacement Lamp Module	SP-LAMP-013
MindPath RF PocketPoint Remote	HW-RF-POCKTPNT
Conductor + Remote	HW-CONDUCTOR +
Integrator Remote	HW-INTEGRATOR
Wireless Connectivity Module	LP-LITESHOW
Wireless Connectivity Module + PC Card	LP-LITESHOWCARD

NOTE: Use only approved accessories.

Red LED Behavior and Projector Errors

If the projector is not functioning properly and the red LED is blinking, consult **Table 2** to determine a possible cause. There are two second pauses between the blinking cycles. Visit our website for more details on the red LED error codes. See the inside back cover for contact details.

Table 2:

Red LED Behavior	Explanation
One (1) blink	The lamp won't strike after five (5) attempts. Check the lamp and lamp door installations for loose connections.
Two (2) blinks	The lamp counter hours have exceeded lamp life hours. Replace the lamp and reset the lamp hours counter.
Three (3) blinks	The projector has shut down the lamp. Turn off the projector and wait one minute, then turn the projector on again. Replace the lamp. Contact Technical Support for repair if replacing the lamp does not solve the problem.
Four (4) blinks	The fan has failed. Contact Technical Support for repair.
Five (5) blinks	The projector is overheating. Check for a blocked air vent. Contact Technical Support for repair if clearing the air vents does not solve the problem.
Solid red	Unidentifiable error: contact Technical Support

Projected image size

Table 3:
Range of distance to the screen for a given screen size

Diagonal Screen Size (inches/m)	Image Width (inches/m)	Distance to screen	
		Maximum distance (feet/m)	Minimum Distance (feet/m)
40/1	32/0.8	5.6/1.7	4.8/1.5
50/1.3	40/1	6.9/2.1	6/1.8
60/1.5	48/1.2	8.2/2.5	7.2/2.2
100/2.5	80/2	13.8/4.2	12.1/3.7

NOTE: Visit our website for an interactive image size calculator.

A

- About 32
- accessories 5, 37
- activation commands for laptops 7
- Advanced menu 30
- advancing slides 6
- Aspect Ratio 32
- audio 24
- audio adapter 11
- Audio In connector 6, 11
- audio volume 13
- Auto Image 22, 32
- Auto Power 31

B

- Blank Screen 32
- blinking green 14
- blinking red 14
- Brightness 10, 28

C

- cleaning the lens 34
- Color 13, 28
- Color Control 30
- Color Space 30
- Color Temperature 30
- colors are incorrect 20
- computer connections
 - optional 6
 - required 6
- computer image
 - optimize 25
- Contrast 10, 13, 28

D

- Display Messages 31
- Drivers 8
 - USB 9
 - Windows 98 9

E

- Effect Key 32
- elevator foot 10

F

- first time use
 - driver installation 8
- focus 10, 13
- Freeze 32
- fuzzy image 17

I

- image
 - displaying computer 7
 - displaying video 12
 - optimizing computer 25
 - optimizing video 26
- image does not fit screen 19
- image edges distorted 18
- image not centered 21
- image not sharp 18
- image not square 18
- image reversed 19
- image size matrix 38
- image torn 19
- Interactive Display 5, 7, 14

K

- keypad buttons 22
- Keystone 10, 13, 22

L

- Lamp Mode 31
- lamp replacement 35
- lamp won't turn on 20, 21
- Language 33
- laptop
 - connecting 6
 - external video port 7

LED

- blinking green 14
- blinking red 20
- solid red 21
- LED behavior 14, 38
- lens cap, attaching 5
- lens cleaning 34
- Low Power 31

M

Main menu 27
menu system 27
Mute 32

N

no computer image 16
no startup screen 15

O

only startup screen appears 15
optional accessories 37
Overscan 30

P

Phase 30
Picture menu 28
Power button 12
power cable 6, 11
Power Save 31
Power-up Source 31
presentation features 25
Presets 29
projector
 accessories 5, 37
 changing language 33
 customizing 26
 optional accessories 37
 resetting 33
 shutdown 14
 standard accessories 37
 troubleshooting problems 14
projector height 10, 12
projector positioning 10, 12, 30, 38

R

Rear 31
remote control
 advancing slides 6, 23
 batteries 23
 Effect key 23
 laser pointer 23
 not working 17
 Previous/Next buttons 23

replacing the lamp 35
reset 33

S

Screen Save 14
Service menu 33
Settings menu 31
Sharpness 30
shutting down projector 14
Source troubleshooting 15
Sources 31, 32
standard accessories 37
Startup Logo 32
S-video adapter 11
S-video connector 11

T

Tint 13, 28
Tracking 30
Troubleshooting 14, 15

U

USB, connecting 6

V

video connections
 optional 11
 standard 11
Video connector 11
video images
 optimizing 26
Video Standard 30

W

warranty 21, 41
Windows 98 8
Windows ME, XP, 2000 9

Z

zoom 10, 13, 32

Limited Warranty

InFocus Corporation (“InFocus”) warrants that the Projector (“Product”) purchased from InFocus, an InFocus distributor, or an InFocus reseller will conform to the manufacturer’s specifications and be free from defects in material or workmanship for the Warranty period provided below. InFocus does not warrant that the Product will meet the specific requirements of the end-user customer.

If the Product, which is the subject of this Limited Warranty, is defective in material or workmanship during the warranty period, InFocus, at its option, will REPAIR or REPLACE the Product.

All exchanged parts and products replaced under this Warranty will become property of InFocus. InFocus’ sole obligation is to supply (or pay for) all labor necessary to repair the Product found to be defective within the Warranty period and to repair or replace defective parts with new parts or, at the option of InFocus, serviceable used parts that are equivalent or superior to new parts performance.

Limited Warranty Alternatives: Subject to the Limitations, Exclusions and Disclaimers, InFocus Warrants as follows:

- **2 Year Parts and Labor Product Warranty** - From the date of purchase, InFocus warrants that the Product will conform to the manufacturers’ specifications and be free from defects in material or workmanship for a period of two (2) years.
- **1 Year Parts Only Accessory Warranty** - From the date of purchase, InFocus warrants that the customer replaceable and accessory products will conform to the manufacturers’ specifications and be free from defects in material or workmanship for a period of one (1) year.
- **90 Day/500 Hour Replacement Lamp Warranty** - Lamp Products purchased in projectors or separately as replacements after the original projector purchase is Ninety (90) days or 500 hours, whichever comes first. During the Warranty period for the Product, InFocus warrants that Replacement lamps, which are purchased at the time of projector purchase, will have a 90-day or 500 hour warranty, whichever comes first, from the date the spare lamp is put into use.

WARRANTY LIMITATION AND EXCLUSION

THIS WARRANTY SETS FORTH INFOCUS’ MAXIMUM LIABILITY FOR ITS PRODUCT. THIS WARRANTY EXTENDS ONLY TO PRODUCTS PURCHASED FROM INFOCUS OR AN INFOCUS AUTHORIZED RESELLER. InFocus shall have no further obligation under the foregoing Limited Warranty if the Product has been damaged due to abuse, misuse, neglect, smoke exposure (cigarette or otherwise), accident, unusual physical or electrical stress, unauthorized modifications (including use of an unauthorized mount), tampering, alterations, or service other than by InFocus or its authorized agents, causes other than from ordinary use or failure to properly use the Product in the application for which said Product was intended.

This Warranty excludes Product or accessory cleaning, repair, or replacement of plastics due to cosmetic damage and damage as a result of normal wear. Product repair outside of the terms of the Limited Warranty will be on a time and materials basis. Prolonged Product “demonstration” causes unusual Product wear and is not considered normal use under the terms of this Limited Warranty.

The Accessory Warranty covers the accessory item only and excludes normal wear. The Lamp Product Warranty excludes expected lamp degradation.

Remanufactured Products and Software Products are exempt from the foregoing Limited Warranty. Please refer to the appropriate Remanufactured Product Limited Warranty or Software Product Limited Warranty for applicable Warranty information.

DISCLAIMER OF UNSTATED WARRANTIES

THE WARRANTY PRINTED ABOVE IS THE ONLY WARRANTY APPLICABLE TO THIS PRODUCT. ALL OTHER WARRANTIES, EXPRESS OR IMPLIED, INCLUDING, BUT NOT LIMITED TO, THE IMPLIED WARRANTIES OF MERCHANTABILITY AND FITNESS FOR PARTICULAR PURPOSE ARE DISCLAIMED. THERE ARE NO WARRANTIES THAT EXTEND BEYOND THE DESCRIPTION ON THE FACE HEREOF AND THE FOREGOING WARRANTY SHALL NOT BE EXTENDED, ALTERED OR VARIED EXCEPT BY WRITTEN INSTRUMENT SIGNED BY INFOCUS. SOME JURISDICTIONS DO NOT ALLOW LIMITATIONS ON HOW LONG AN IMPLIED WARRANTY MAY LAST, SO SUCH LIMITATIONS MAY NOT APPLY TO YOU.

Limited Warranty Period

The Limited Warranty period commences on the date of purchase by the end-user customer for both the 2 year Product Warranty and the 1 year Accessory Warranty. These Limited Warranty provisions shall apply only to the end-user purchaser (first person or entity that purchased a new Product for personal or business use and not for the purpose of distribution or resale).

To Be Eligible For Limited Warranty Coverage

Any person exercising a claim under this Limited Warranty must establish to the satisfaction of InFocus both the date of purchase and that the Product was purchased new. The sales receipt or invoice, showing the date of purchase of the Product or Accessory is the proof of the date of purchase.

To Obtain Warranty Service

During the Limited Warranty period, to exercise this Limited Warranty, the purchaser must first contact 1) InFocus, 2) a service facility authorized by InFocus or 3) the place of original purchase.

InFocus Customer Service - 1-800-799-9911 or techsupport@infocus.com

For Warranty service, the purchaser will be advised to return or deliver the defective Product freight and all fees prepaid, to an InFocus Service Center or to a service facility authorized by InFocus. When returning Product to InFocus, a Return Material Authorization Number (RMA #) is required and must be clearly displayed on the outside of the shipping carton or a similar package affording an equal degree of protection. InFocus or the service facility authorized by InFocus will return the repaired/replaced Product freight prepaid to the purchaser.

Products returned for Warranty service must be accompanied by a written letter that: (i) explains the problem; (ii) provides proof of date of purchase; (iii) provides the dealer's name; and (iv) provides the model and serial number of the Product. Upon request of InFocus Corporation or an InFocus authorized repair center receiving the Product, proof of legal importation must accompany the warranty repair Product, otherwise the Product must be returned to the place of original purchase, to the manufacturer (Purchaser must bear all tax, duty and freight), or the Purchaser must bear charges for the warranty repair.

No repair or replacement of Product or part thereof shall extend the Limited Warranty period as to the entire Product. Warranty on the repair part and workmanship shall only be effective for a period of ninety (90) days following the repair or replacement of that part or the remaining period of the Product Limited Warranty whichever is greater.

LIMITATION OF LIABILITY

IT IS UNDERSTOOD AND AGREED THAT INFOCUS' LIABILITY WHETHER IN CONTRACT, IN TORT, UNDER ANY WARRANTY, IN NEGLIGENCE OR OTHERWISE SHALL NOT EXCEED THE RETURN OF THE AMOUNT OF THE PURCHASE PRICE PAID BY PURCHASER AND UNDER NO CIRCUMSTANCES SHALL INFOCUS BE LIABLE FOR SPECIAL, INDIRECT, INCIDENTAL OR CONSEQUENTIAL DAMAGES OR LOST PROFITS, LOST REVENUES OR LOST SAVINGS. THE PRICE STATED FOR THE PRODUCTS IS A CONSIDERATION IN LIMITING INFOCUS' LIABILITY.

Limitation on Bringing Action - No action, regardless of form, arising out of the agreement to purchase the product may be brought by purchaser more than one year after the cause of action has accrued.

Governing Law - Any action, regardless of form, arising out of the agreement to purchase the product is governed by Oregon law.

Mandatory Arbitration - Any action, regardless of form, arising out of the agreement to purchase the product is subject to mandatory arbitration.

SOME JURISDICTIONS DO NOT ALLOW THE EXCLUSION OR LIMITATION OF INCIDENTAL OR CONSEQUENTIAL DAMAGES SO THE ABOVE LIMITATION OR EXCLUSION MAY NOT APPLY TO YOU. THIS LIMITED WARRANTY GIVES YOU SPECIFIC LEGAL RIGHTS, AND YOU MAY ALSO HAVE OTHER RIGHTS, DEPENDING ON JURISDICTION.

IF YOU NEED ASSISTANCE...

call your ASK partner or InFocus Corporation Customer Service directly at (+31) 20 579 2820.

SUPPORT IS FREE between 8 a.m. and 6 p.m. CET, Monday through Friday. Support is available in EMEA after hours and weekends for a fee at **(+31) 20 579 2828**.

Or, send us an e-mail at **emea.support@infocus.com**.

IN NORTH AMERICA, call InFocus Corporation at **1-800-799-9911**.

Support is free between 6 a.m. and 6 p.m. PST, Monday through Friday. Support is available in North America after hours and weekends for a fee at **1-888-592-6800**.

Or, send us an e-mail at **techsupport@infocus.com**.

IN ASIA, call InFocus Corporation in Singapore at **(65) 6334-9005**.

Many resources are available on our website at **www.askprojectors.com**. Here's a sample:

- product data sheet at **www.askprojectors.com/M1**
- technical specifications, an interactive image size calculator, laptop activation commands, connector pin outs, command line interface (CLI) and a glossary at **www.askprojectors.com/support**
- product registration at **www.infocus.com/register**

///ASK M1



010-0470-00

InFocus Corporation

27700B SW Parkway Avenue
Wilsonville, Oregon 97070-9215
1-800-294-6400 • 503-685-8888
Fax: 503-685-8887
<http://www.infocus.com>

In Europe:

InFocus International B.V.
Strawinskylaan 585
1077 XX Amsterdam, The Netherlands
Phone: +31 20 579 2000
Fax: +31 20 579 2999

In Asia:

238A Thomson Road
#18-01/04 Novena Square
Singapore 307684
Telephone: (65) 6334-9005
Fax: (65) 6333-4525

InFocus[®]
C O R P O R A T I O N