

***myprojectorlamps.com***

**The most trusted, dependable name  
in projector lamp sales.**



<http://www.myprojectorlamps.com>



<http://www.myprojectorlamps.ca>



<http://www.myprojectorlamps.eu>

The following projector manual has not been modified or altered in any way.



## Declaration of Conformity

Manufacturer: InFocus Corporation, 27500 SW Parkway Ave. Wilsonville, Oregon  
97070 USA

European Office: Olympia 1, NL-1213 NS Hilversum, The Netherlands

We declare under our sole responsibility that the C40/C50 projectors conform to the following directives and norms:

EMC Directive 89/336/EEC, Amended by 93/68/EEC

EMC: EN 55022

EN 55024

EN 61000-3-2

EN 61000-3-3

Low Voltage Directive 73/23/EEC, Amended by 93/68/EEC

Safety: EN 60950: 2000

July, 2002

## Australian Certification C-tick mark



## Trademarks

Apple, Macintosh, and PowerBook are trademarks or registered trademarks of Apple Computer, Inc. IBM and PS/2 are trademarks or registered trademarks of International Business Machines, Inc. Microsoft, PowerPoint, and Windows are trademarks or registered trademarks of Microsoft Corporation. InFocus is a trademark or registered trademark of InFocus Corporation.

## FCC Warning

Note: This equipment has been tested and found to comply with the limits for a Class B digital device, pursuant to part 15 of the FCC Rules. These limits are designed to provide reasonable protection against harmful interference in a residential installation. This equipment generates, uses and can radiate radio frequency energy and, if not installed and used in accordance with the instructions, may cause harmful interference to radio communications. However, there is no guarantee that interference will not occur in a particular installation. If this equipment does cause harmful interference to radio or television reception, which can be determined by turning the equipment off and on, the user is encouraged to try to correct the interference by one or more of the following measures:

--Reorient or relocate the receiving antenna.

--Increase the separation between the equipment and receiver.

--Connect the equipment into an outlet on a circuit different from that to which the receiver is connected.

--Consult the dealer or an experienced radio/TV technician for help.

## Canada

This Class B digital apparatus complies with Canadian ICES-003.

Cet appareil numérique de la classe B est conforme à la norme NMB-003 du Canada.

## Safety Certifications

UL, CUL, TÜV, NOM, IRAM, GOST

## Table of Contents

Introduction	5
Connecting a computer	6
Required computer connections	6
Displaying a computer image	7
Using the projector with Windows 98 for the first time	8
Adjusting the image	9
Connecting a video device	10
Standard video connections	10
Displaying a video image	11
Shutting down the projector	13
Troubleshooting your setup	13
Using the remote control	21
Using the audio	22
Using the keypad buttons	22
Optimizing computer images	23
Presentation features	23
Optimizing video images	24
Customizing the projector	24
Using the menus	25
Picture menu	26
Settings menu	29
Maintenance	33
Cleaning the lens	33
Cleaning the dust filter	33
Replacing the projection lamp	34
Cleaning the lamp housing screens	36
Appendix	37
Specifications	37
Accessories	37
Projected image size	38
Index	39

If you are experienced in setting up presentation systems, use the *Quick Setup* card that was included. For complete details on connecting and operating the projector, refer to this User's Guide. Electronic versions of this user's guide in multiple languages are available on the included CD.

### Important Operating Considerations

Do not place the projector on a tablecloth or other soft covering that may block the vents. Do not use a non-approved ceiling mount. In the unlikely event of the bulb rupturing, thoroughly clean the area behind the projector and discard any edible items placed in that area.

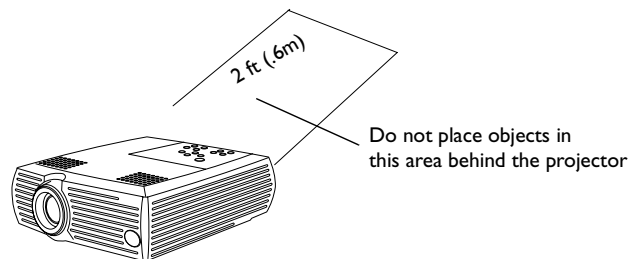



# Introduction

Your new digital projector is easy to connect, easy to use, and easy to maintain. The C40 has native SVGA 800x600 resolution, the C50 has native XGA 1024x768 resolution.

## Included items

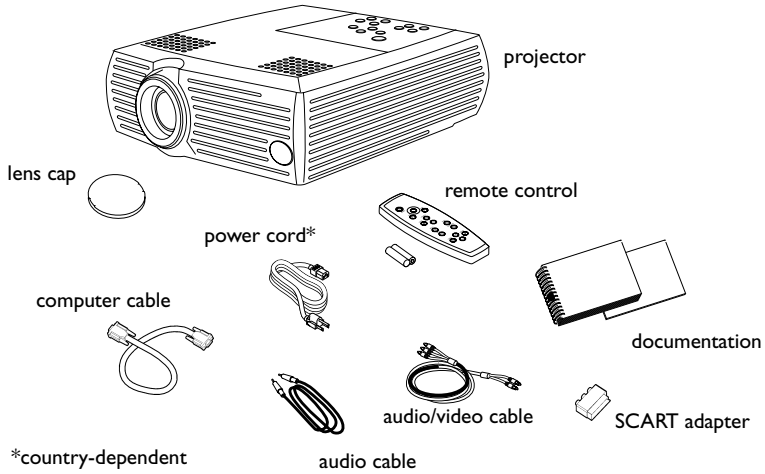

## Projector components

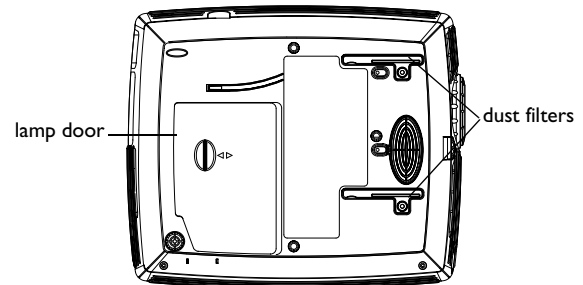
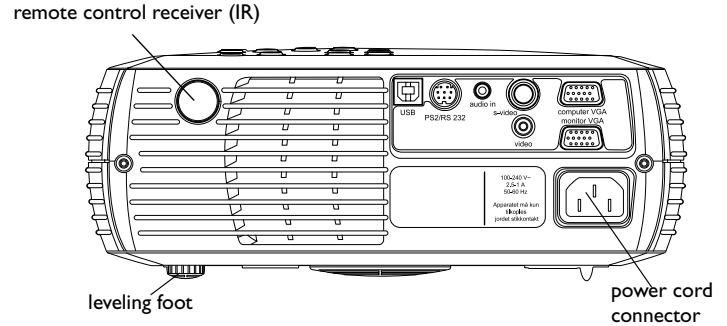
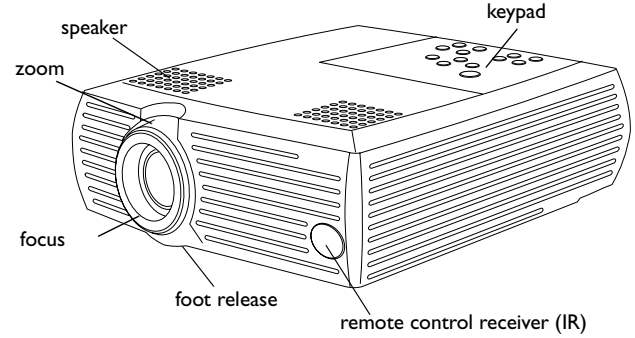

# Connecting a computer

## Required computer connections

Connect one end of the computer cable to the blue **Computer In** connector on the projector. Connect the other end to the video port on your computer. If you are using a desktop computer, you will need to disconnect the monitor cable from the computer's video port first.

connect computer cable

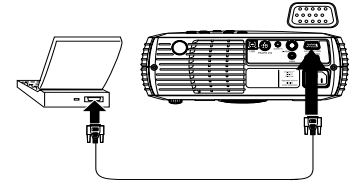

Connect the black power cord to the connector on the back of the projector and to your electrical outlet.

The Power LED on the keypad lights green.

**NOTE:** Always use the power cord that shipped with the projector.

connect power cable

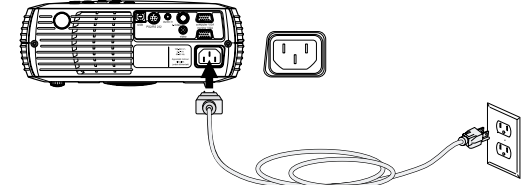

## Optional computer connections

To have sound with your presentation, connect the audio cable to your computer and to the Audio In connector on the projector.

connect audio cable

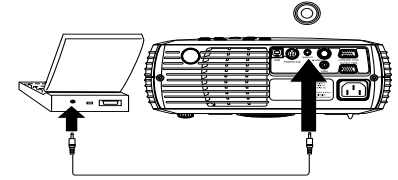

To control your computer's mouse using the projector's remote control, connect a USB or PS2 cable (ordered separately) to the projector and the computer. USB drivers must be installed to use the USB feature.

connect mouse cable

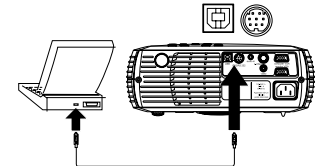

If you are using a desktop computer and want to see the image on your computer screen as well as on the projection screen, connect the monitor cable to the Monitor Out connector on the projector.

connect monitor cable

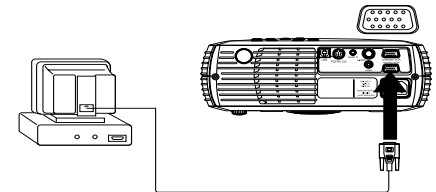

# Displaying a computer image

Remove the lens cap.

remove lens cap

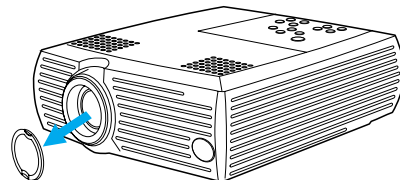

Press the **Power** button on the top of the projector.  
The LED flashes green and the fans start to run. When the lamp comes on, the startup screen is displayed and the LED is steady green. It can take a minute for the image to achieve full brightness.

press Power

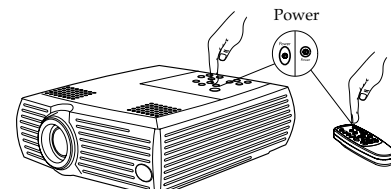

**? No startup screen?** Get help on page 13.

Turn on your computer.  
The computer's image should appear on the projection screen. If it doesn't, press the **Computer** button on the keypad.

turn on computer



Make sure your laptop's external video port is active.  
Many laptops do not automatically turn on their external video port when a projector is connected. Usually a key combination like FN + F5 is used to turn the external display on and off. Refer to your computer's documentation to learn your computer's key combination.

activate laptop's external port

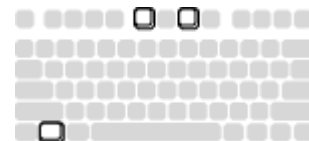

**? No computer image?** Try pressing the **Auto Image** button on the keypad. Get help on page 14.



## Using the projector with Windows 98 for the first time

The first time you connect a computer running Windows 98 to the projector, the computer recognizes the projector as “new hardware” and the Add New Hardware Wizard appears. Follow these instructions to use the Wizard to load the correct driver (which was installed with your Windows operating system).

If you are running Windows 2000 or Windows ME, skip these steps and go to “Adjusting the image” on page 9.

- a Click **Next** to begin searching for the driver.
- b Make sure “Search for the best driver” is selected, then click **Next**.
- c Uncheck any checked boxes, then click **Next**. Windows automatically locates the driver. If this driver has been removed, reload the driver using your Windows operating system CD.
- d When Windows finds the driver, you are ready to install it. Click **Next**.

a



b

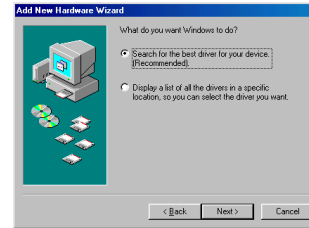

c



d

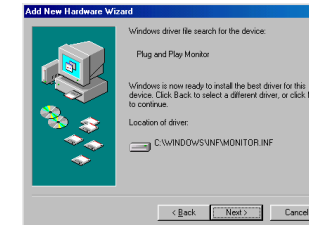

## Adjusting the image

Adjust the height of the projector, if necessary, by pressing the release button to extend the foot.  
Rotate the leveling foot, if necessary.

adjust height

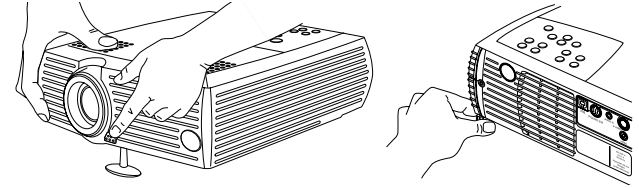

Position the projector the desired distance from the screen at a 90 degree angle to the screen.  
See page 38 for a table listing screen sizes and distances.

adjust distance

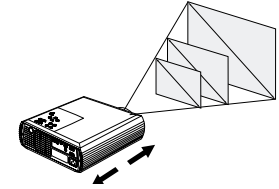

Adjust the zoom or focus.

adjust zoom and focus

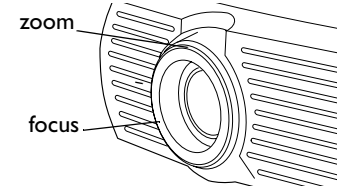

If the image is not square, adjust the keystone using the buttons on the keypad.  
Press the top **Keystone** button to reduce the upper part of the image, and press the bottom **Keystone** button to reduce the lower part.

adjust keystone

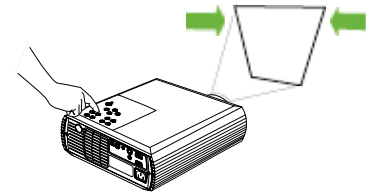

Adjust the Contrast or Brightness in the Picture menu.  
See page 25 for help with the menus.

adjust Picture menu



Picture	
Exit	
Keystone	50
Contrast	50
Brightness	50
Color	50
Tint	50
Aspect ratio	>
Presets	>
Room Lighting	>
Advanced	>

# Connecting a video device

## Standard video connections

Plug the audio/video (A/V) cable's yellow connector into the video-out connector on your video device. Plug the other yellow connector into the yellow **Video** connector on the projector.

Plug the white connector into the left audio out connector on your video device; plug the red connector into the right audio out connector on the video device. Plug the blue connector into the **Audio In** connector on the projector.

connect A/V cable

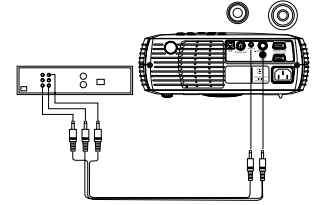

Connect the power cord to the connector on the back of the projector and to your electrical outlet. The Power LED on the keypad lights green.

**NOTE:** Always use the power cord that shipped with the projector.

connect power cable

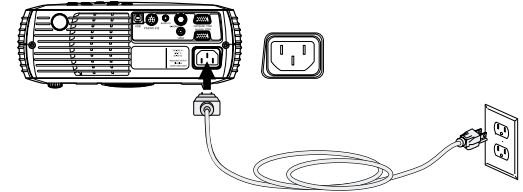

## Optional video connections

If your video device uses a round, four-prong S-video connector, plug an S-video cable, sold separately, into the S-video connector on your video device and into the S-video connector on the projector. Use the A/V cables as described above (the yellow connectors on the A/V cable are not used).

connect S-video and A/V cables

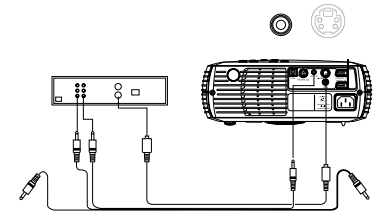

# Displaying a video image

Remove the lens cap.

remove lens cap

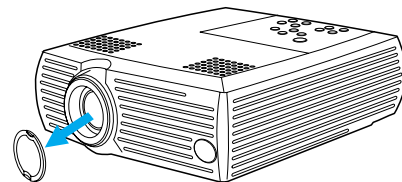

Press the **Power** button on the top of the projector. The LED flashes green and the fans start to run. When the lamp comes on, the startup screen is displayed and the LED is steady green. It can take a minute for the image to achieve full brightness.

press Power

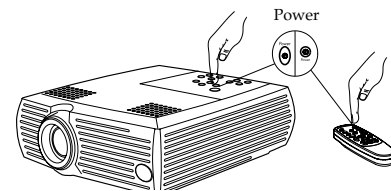

**? No startup screen?** Get help on page 13.

Plug in and turn on your video device. The video device's image should appear on the projection screen. If it doesn't, press the **Video** button on the keypad.

turn on video device

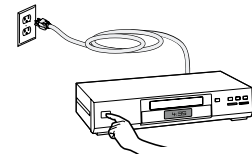

**? No video image?** Get help on page 17.

Adjust the height of the projector by pressing the release button to extend the foot. Rotate the leveling foot, if necessary.

adjust height

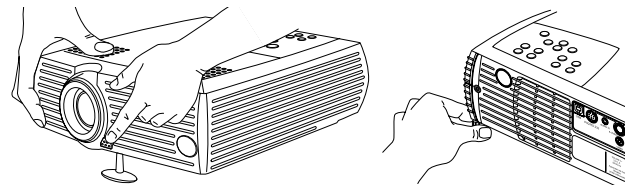

Position the projector the desired distance from the screen at a 90 degree angle to the screen.

See page 38 for a table listing screen sizes and distances to the screen.

adjust distance

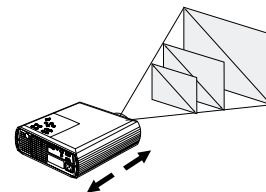

Adjust the zoom and focus.

adjust zoom and focus

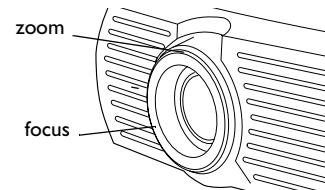

If the image is not square, adjust the keystone using the buttons on the keypad. Press the top **Keystone** button to reduce the upper part of the image, and press the bottom **Keystone** button to reduce the lower part.

adjust keystone

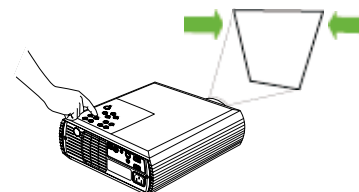

Adjust the volume on the keypad or remote.

adjust volume

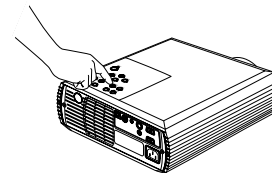
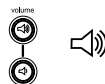

Adjust the Contrast, Brightness, Color, or Tint in the Picture menu. See page 25 for help with the menus.

adjust Picture menu



Picture	
Exit	
Keystone	50
Contrast	50
Brightness	50
Color	50
Tint	50
Aspect ratio	>
Presets	>
Room Lighting	>
Advanced	>

## Shutting down the projector

The projector automatically displays a gray screen after no active source is detected for 30 minutes. This gray screen helps preserve the life of the projector. The image returns when an active source is detected or a remote or keypad button is pressed.

You can make the gray screen appear after 5 minutes by turning on the Screen Save feature in the **Settings>System** menu. See page 29.

The projector also has a Power Save feature that automatically turns the lamp off after no active sources are detected for 5 minutes. By default, this feature is off. See page 29.

To turn off the projector, press the **Power** button and verify that you want to turn the projector off by pressing the **Power** button again within 3 seconds. You can cancel the shutdown by not pressing the **Power** button a second time. The lamp turns off and the LED blinks green for 1 minute while the fans continue to run to cool the lamp. When the lamp has cooled, the LED lights green and the fans stop. Unplug the power cable to power off the projector completely.

## Troubleshooting your setup



If your image appears correctly on the screen, skip to the next section. If it does not, troubleshoot the setup.

The LED on top of the projector indicates the state of the projector and can help you troubleshoot.

**Table 1: LED behavior and meaning**

LED color/behavior	Meaning
solid green	The projector is plugged in, or the projector has been turned on and the software has initialized, or the projector has been turned off and the fans have stopped.
blinking green	The <b>Power</b> button has been pressed and the software is initializing, or the projector is powering down and the fans are running to cool the lamp.
blinking red	A fan or lamp failure has occurred. Turn off the projector and wait one minute, then turn the projector on again. If the projector has been working for 2000 hours or more (page 31), replace the lamp and reset the lamp timer. Also check for a blocked vent or a stopped fan.
solid red	An unidentifiable error: please contact Technical Support.

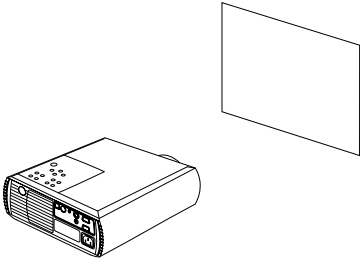
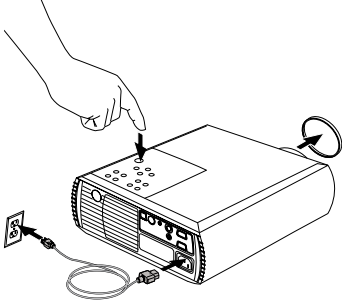
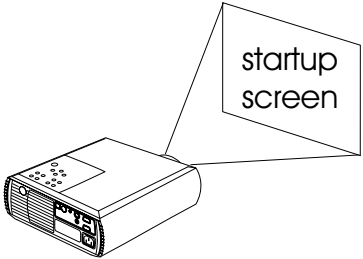
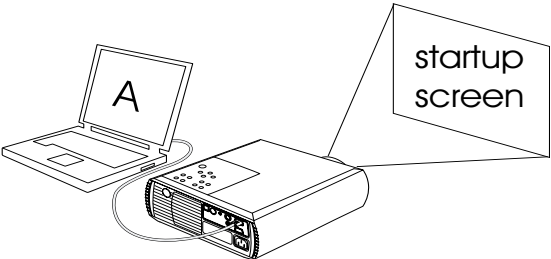
The following tables show common problems. In some cases, more than one possible solution is provided. Try the solutions in the order they are presented. When the problem is solved, you can skip the additional solutions.

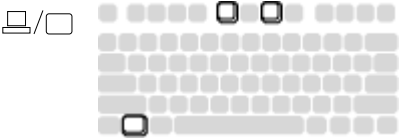
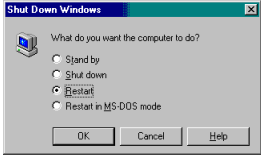
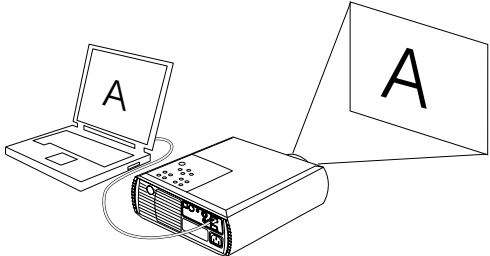
Problem	Solution	Result
<p data-bbox="53 196 256 219"><b>No startup screen</b></p> 	<p data-bbox="664 165 887 245"><b>Plug power cord in</b> <b>Remove lens cap</b> <b>Press Power button</b></p> 	<p data-bbox="1187 196 1355 219"><b>Correct image</b></p> 
<p data-bbox="53 586 371 609"><b>Only startup screen appears</b></p> 	<p data-bbox="664 621 979 678"><b>Press the Computer button</b>  <b>Activate laptop's external port</b></p>  <p data-bbox="682 877 843 900"><b>Restart laptop</b></p> 	<p data-bbox="1187 586 1494 609"><b>Computer image projected</b></p> 

**Problem**

**No computer image, just the words “Signal out of range”**

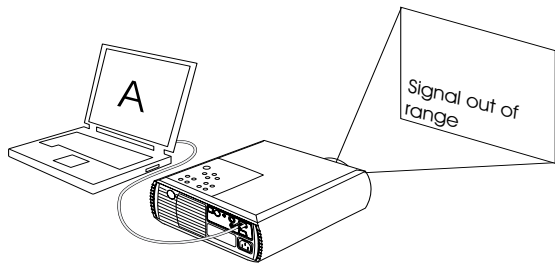

**Solution**

**Adjust computer refresh rate in Control Panel>Display>Settings>Advanced >Adapter (location varies by operating system)**

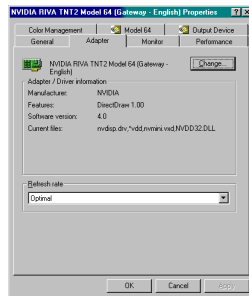

**You may also need to set a different resolution on your computer, as shown in the following problem, “Image fuzzy or cropped.”**

**Result**

**Computer image projected**

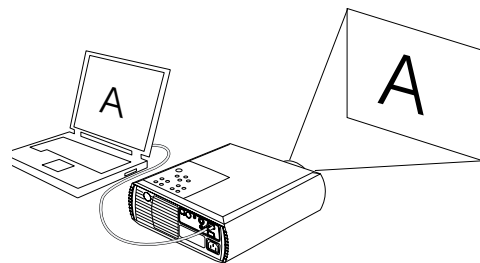



### Image fuzzy or cropped

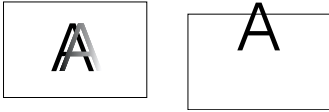

**Set your computer's display resolution to the native resolution of the projector**  
**(Start>Settings>Control Panel>Display>Settings tab, select 800x600 for the C40, 1024x768 for C50)**

**For a laptop, disable laptop monitor or turn-on dual-display mode**

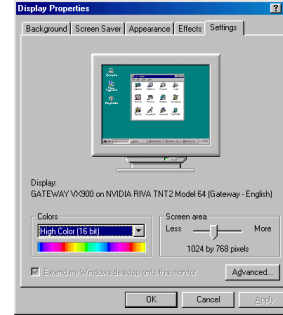

### Image clear and not cropped



### Remote control not controlling my computer's mouse

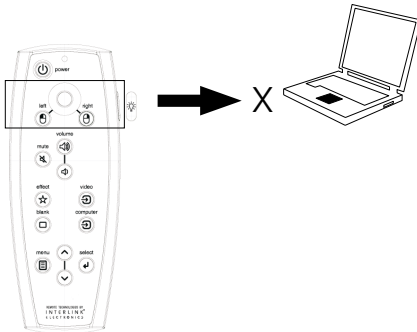

### Connect optional mouse cable (page 6)

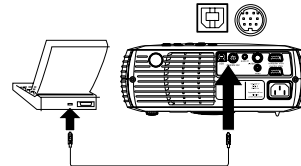

### Load USB drivers, if necessary (page 8)

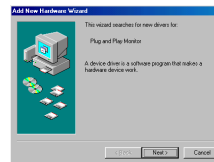

**See page 21 for more info on the remote**

### Remote controls computer cursor (note that the mouse is not functional in zoom mode). See page 21 for information on the remote.

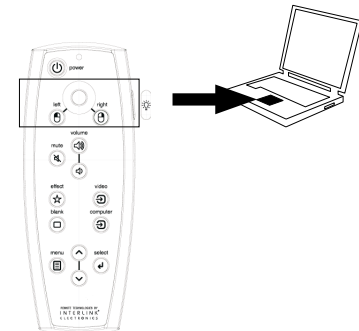

### Image not centered on screen

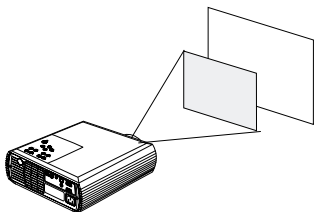

### Move projector, adjust zoom, adjust height

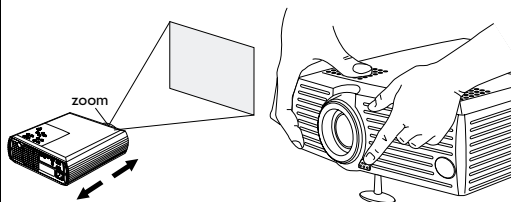

### Adjust horizontal or vertical position in Picture>Advanced menu

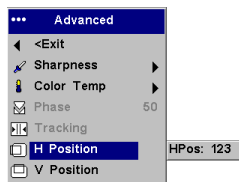

### Correct image

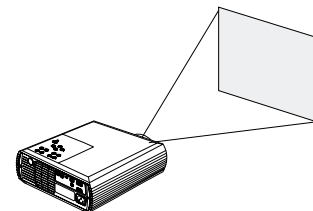

### Image not square

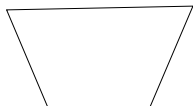

### Adjust keystone on keypad

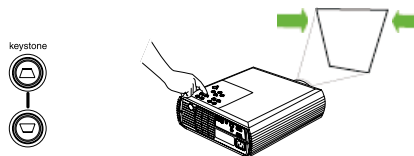

### Square image



Image not sharp

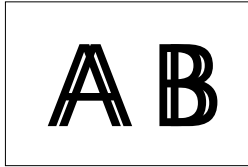

Adjust Sharpness in the Picture>Advanced menu

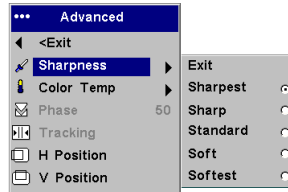

Correct image



Image does not fit 16:9 screen

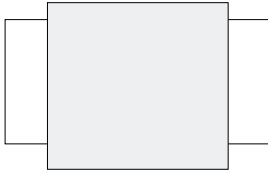

Change aspect ratio to 16:9 in Picture>Aspect ratio menu

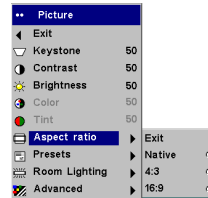

Correct image



Image upside down

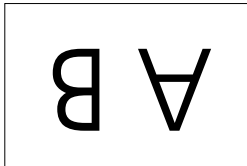

Turn on/off Ceiling in Settings>System menu

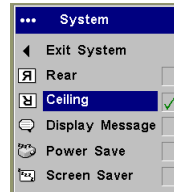

Correct image



Image reversed left to right

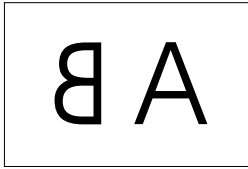

Turn on/off Rear in Settings>System menu

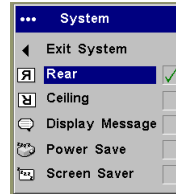

Correct image



Projected colors don't match source

~~COLOR~~

Adjust color, tint, color temperature, brightness, contrast in the menus

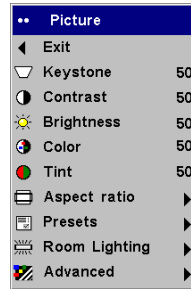

Correct image

COLOR

Lamp won't turn on, LED blinking red

blinks red

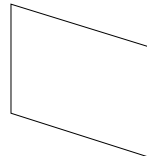
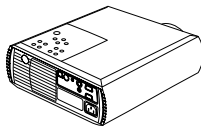

Make sure vents aren't blocked, turn off the projector and allow it to cool for a minute

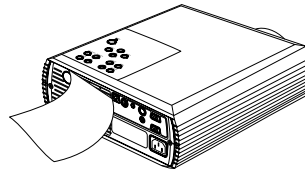

Lamp turns on

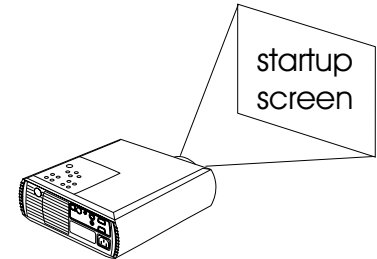

Lamp won't turn on, LED blinking red, "Change lamp" message appears at startup

blinks red

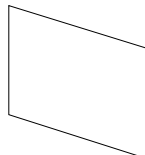
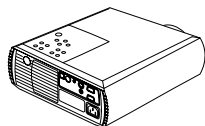

If lamp hours > 2000, lamp must be replaced. See page 34.

Check lamp hours:  
should be less  
than 2000 hours  
in the  
Main>About menu

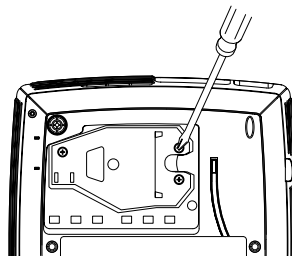
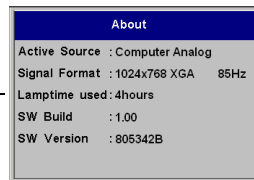

Lamp turns on

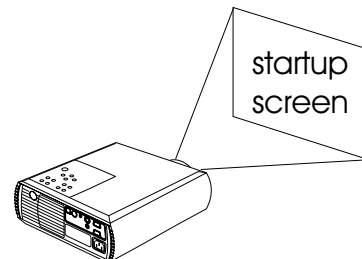

### Still having problems?

If you need assistance, call Customer Service.

In Europe, call Customer Service in The Netherlands at **(31) 35-6474010**.

In the United States, call Customer Service at **1-800-799-9911**. Support is free between 6 a.m. and 6 p.m. PST, Monday through Friday. Support is available in North America after hours and weekends for a fee at 1-888-592-6800.

In Asia, call Customer Service in Singapore at **(65) 6334-9005**.

Or, send us an e-mail at [techsupport@infocus.com](mailto:techsupport@infocus.com).

This product is backed by a limited two-year warranty. An extended warranty plan may be purchased from your dealer. When sending your projector in for repair, we recommend shipping the unit in its original packing material, or having a professional packaging company pack the unit for shipping. Please insure your shipment for its full value.

## Using the remote control

To install the 2 AAA batteries, slide the cover off the back of the remote, align the + and – ends of the batteries and slide into place, then replace the cover.

To operate, point the remote at the projection screen or at the front/rear of the projector (not at the computer). The range of optimum operation is about 30 feet (9.1m).

The remote has a cursor control and left and right mouse buttons. These buttons mimic the cursor movement and left and right mouse buttons on your computer. To use these buttons to control your computer's mouse, you must connect a USB or PS/2 mouse cable to the projector. See page 6. When you do this for the first time, the Add New Hardware wizard may appear.

Press the **Menu** button to open the menus, use the up and down arrow buttons to navigate in the menus and the **Select** button to select features and adjust values in the menus. See page 25 for more info on the menus.

The remote also has a **Power** button to turn the projector on and off (see page 13 for shutdown info), **Volume** and **Mute** buttons to control the sound, and **Video** and **Computer** buttons to switch between sources.

Several presentation-specific features are also provided. Use the **Blank** button to display a blank screen instead of the current image (you can choose which color is displayed, see page 30); use the **Effect** button to invoke a user-definable action, such as freeze or zoom (see page 30 to learn to program this button). The remote also has a backlight button which illuminates the remote so you can see the buttons in a dark room. The light stays on for 10 seconds or until you press the backlight button again.

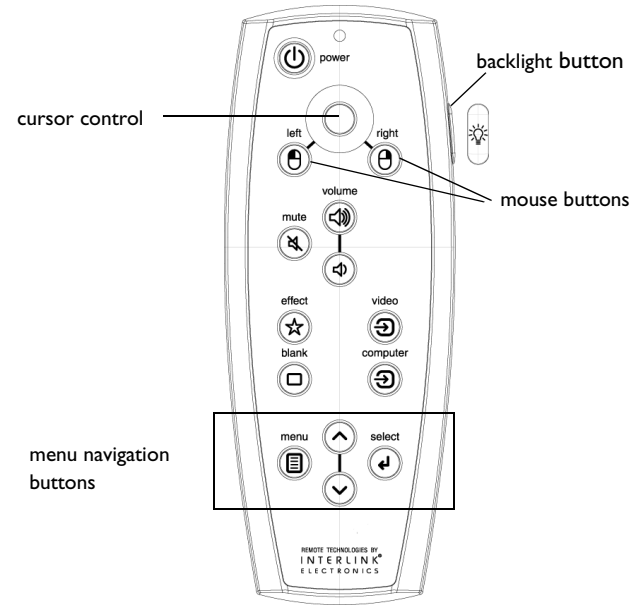

## Troubleshooting the remote

- Make sure the batteries are installed in the proper orientation and not dead. If the LED does not light when a button is pressed, the batteries are dead.
- Make sure you're pointing the remote at the projector, not the computer, and are within the remote range of 30 feet (9.1m).
- Make sure there are no obstacles between you and the projector.
- If you are trying to control your computer's mouse, make sure the USB or PS/2 cable is connected. If using a USB cable, make sure the correct drivers are installed.

## Using the audio

To use the projector's speaker, connect your source to the **Audio In** connector on the projector.

To adjust the volume, use the **Volume** buttons on the keypad or remote.

To mute the sound, press the **Mute** button on the remote.

### Troubleshooting Audio

- If you aren't hearing the audio, check the following:
- Make sure the audio cable is connected.
- Make sure mute is not active (press the **Mute** button on the remote).
- Make sure the volume is turned up enough. Press the **Volume** button on the keypad or remote.
- Make sure the correct source is active.
- Adjust the audio source. If playing a video, make sure the playback has not been paused.

connect audio cable

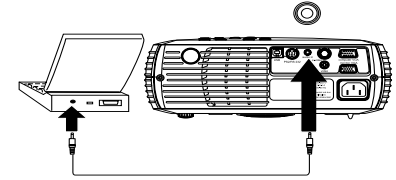

adjust volume

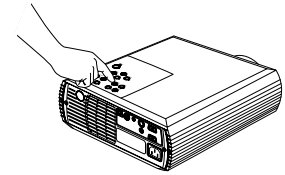
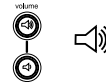

## Using the keypad buttons

Most buttons are described in detail in other sections, but here is an overview of their functions:

**Power:** turns the projector on (page 7) and off (page 13).

**Menu:** opens the on-screen menus (page 25).

**Select:** confirms choices made in the menus (page 25).

**Up/Down arrows:** navigates to and adjusts settings in the menus (page 25).

**Auto Image:** resets the projector to the connected source.

**Presets:** cycles through the available preset settings (page 27).

**Keystone:** adjusts squareness of the image (page 9).

**Volume:** adjusts sound (page 22).

**Video** and **Computer:** changes the active source.

menu navigation buttons

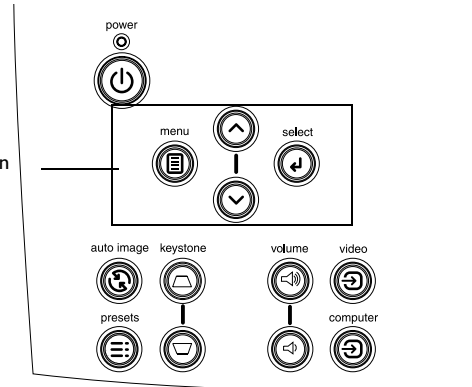

## Optimizing computer images

After your computer is connected properly and the computer's image is on the screen, you can optimize the image using the onscreen menus. For general information on using the menus, see page 25.

- Adjust the Keystone, Contrast, or Brightness in the Picture menu (page 26).
- Change the Aspect Ratio. Choose the option that best fits your input source (page 26).
- Adjust the Sharpness or Color Temperature in the Advanced menu (page 28).
- Adjust the Phase, Tracking, or Horizontal or Vertical Position in the Advanced menu (page 28).
- Adjust the Room Lighting. This allows you to adjust for a dark or light room. Select Dark if you are in a dark room, Light if in a bright room (page 27).
- Once you have optimized the image for a particular source, you can save the settings using Presets. This allows you to quickly recall these settings later (page 27).

## Presentation features

Several features are provided to make giving presentations easier. Here is an overview, details are found in the menu section.

- The **Effect** button on the remote allows you to assign various features to the button. The default effect is About, which displays information about the projector and current source. You can select among blank, mute, aspect ratio, source, auto image, freeze, zoom, PiP (Picture in Picture), mask and about. See page 30 for details. The freeze effect allows you to freeze the displayed image. This is useful if you want to make changes on your computer without your audience seeing them. The mask effect allows you to cover part of the image with a black curtain.
- The **Blank** button on the remote allows you to display a blank screen instead of the active source (page 30).
- The Startup Logo option lets you change the default startup screen to a black, white, or blue screen (page 30).
- Two options, Power Save and Screen Save, are provided to automatically shut down the projector after several minutes of inactivity or display a gray screen. This helps preserve lamp life (page 29).



## Optimizing video images

After your video device is connected properly and the image is on the screen, you can optimize the image using the onscreen menus. For general information on using the menus, see page 25.

- Adjust the Keystone, Contrast, Brightness, Color, or Tint in the Picture menu (page 26).
- Change the Aspect ratio. Choose the option that best fits your input source (page 26).
- Select a Sharpness setting (page 28).
- Adjust the Color Temperature. Select a listed value, or select User and individually adjust the intensity of the red, green, and blue color (page 28).
- Adjust the Room Lighting. Select Dark if you are in a dark room, Light if in a bright room (page 27).

## Customizing the projector

You can customize the projector for your specific setup and needs. See page 29 to page 31 for details on these features.

- For rear projection, turn Rear mode on in the **Settings>System** menu.
- For ceiling mounted projection, turn ceiling mode on in the **Settings>System** menu.
- Specify which source the projector checks first for active video during power-up.
- Specify the function of the **Effect** button on the remote.
- Turn the projector's display messages on and off.
- Turn on power saving features.
- Specify blank screen colors and startup logos.
- Specify the menu language.
- Save settings for the active source as a preset.

# Using the menus

To open the menus, press the **Menu** button on the keypad or remote. (The menus automatically close after 60 seconds if no buttons are pressed.) The Main menu appears. Use the arrow buttons to move up and down to highlight the desired submenu, then press the **Select** button.

To change a menu setting, highlight it, press select, then use the up and down arrow buttons to adjust the value, select an option using radio buttons, or turn the feature on or off using check boxes. Press select to confirm your changes. Use the arrows to navigate to another setting. When your adjustments are complete, navigate to Exit, then press Select to go to the previous menu; press the **Menu** button at any time to close the menus.

Dots appear before the menu name. The number of dots indicates menu's level, ranging from 1 (the Main menu) to 4 (the most nested menus).

The menus are grouped by usage. The Picture menu provides image adjustments; the Settings menu provides set-up type adjustments that are not changed often, and the About menu provides a read-only display of information about the projector and source.

Certain menu items may be grayed out until a particular source is connected. For example, Sharpness is only available for video sources and will be grayed out when a computer source is active.

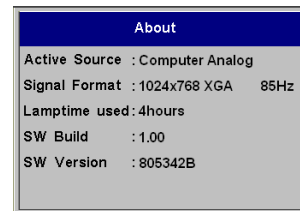
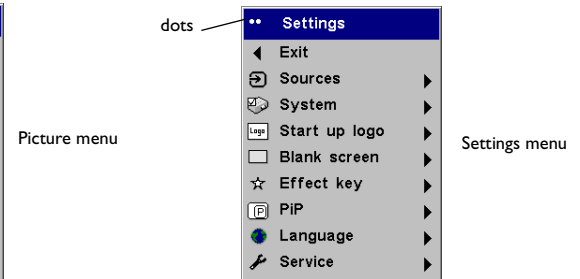
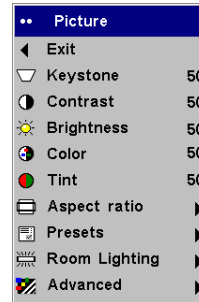
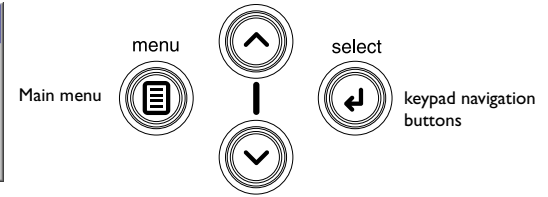
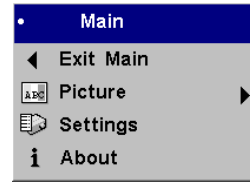

## Picture menu

To adjust the following five settings, highlight the setting, press select, use the up and down arrows to adjust the values, then press select to confirm the changes.

**Keystone:** adjusts the image vertically and makes a squarer image. You can also adjust keystone from the keypad.

**Contrast:** controls the degree of difference between the lightest and darkest parts of the picture and changes the amount of black and white in the image.

**Brightness:** changes the intensity of the image.

**Color:** adjusts a video image from black and white to fully saturated color.

**NOTE:** The color setting applies to video sources only. The tint setting applies to NTSC video sources only.

**Tint:** adjusts the red-green color balance in the image of NTSC video images.

**Aspect Ratio:** Aspect ratio is the ratio of the image width to image height. TV screens are usually 1.33:1, also known as 4:3. HDTV and most DVDs are 1.78:1, or 16:9. The default is 4:3.

Select Native to see the unmodified input with no resizing by the projector. Select 16:9 to watch enhanced widescreen DVDs.

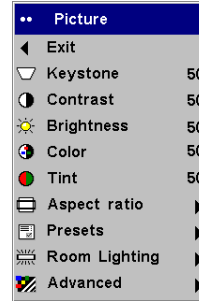

Picture menu

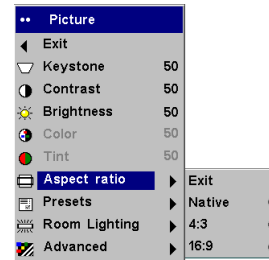
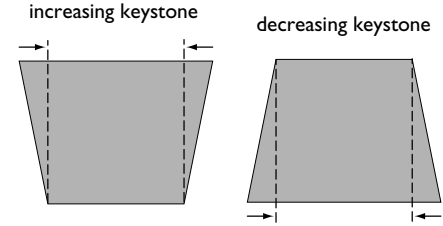

Aspect ratio

**Presets:** Presets are provided that optimize the projector for displaying computer presentations, photographs, film images, and video images. (Film input is material originally captured on a film camera, like a movie; video input is material originally captured on a video camera, like a TV show or sporting event.) You can use the preset as a starting point, then further customize the settings for each source. The settings you customize are saved in the preset for each source. To restore the factory default settings, choose Factory Reset in the **Settings>Service** menu (page 31).

There is also a user-definable preset. To set a preset for the current source, adjust the image, select Save User in the Presets menu, then select Yes. You can recall these settings in the future by selecting the User 1 preset.

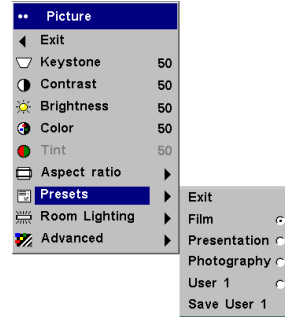

Presets

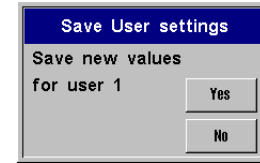

Save User Settings

**Room Lighting:** This feature optimizes the projector for your room's lighting conditions. Select Dark if you are in a dark room, Light if in a bright room. Choosing Light maximizes the light output from the projector.

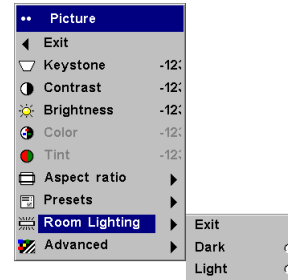

Room Lighting

## Advanced menu

**Sharpness:** (video sources only) changes the clarity of the edges of a video image. Select a sharpness setting.

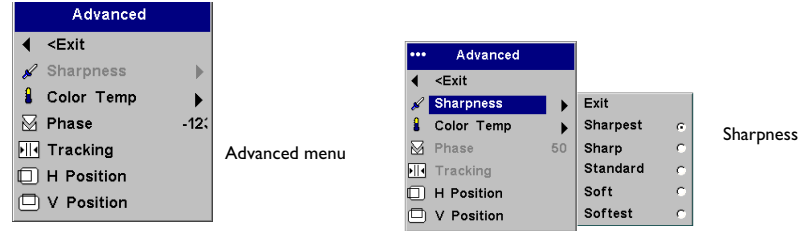

**Color Temperature:** changes the intensity of the colors. Select a listed value, or select User and individually adjust the intensity of the red, green, and blue color.

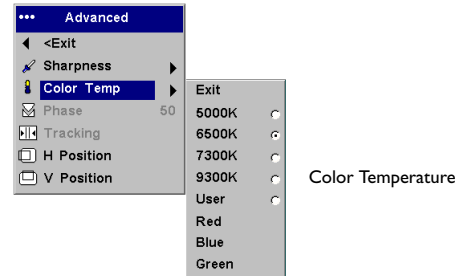

The following 4 options are for computer sources only.

**Phase:** adjusts the horizontal phase of a computer source.

**Tracking:** adjusts the vertical scan of a computer source.

**Horizontal/Vertical Position:** adjusts the position of a computer source.

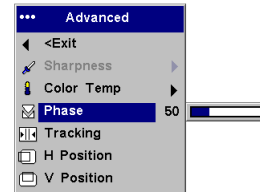

## Settings menu

**Sources>Startup Source:** this determines which source the projector checks first for active signal during power-up.

**Autosource:** When this feature is On, the projector automatically finds the active source, checking the Startup Source first. When this feature is Off, the projector defaults to the source selected in Startup Source. To display another source, you must manually select one by pressing the **Computer** or **Video** button on the remote or keypad.

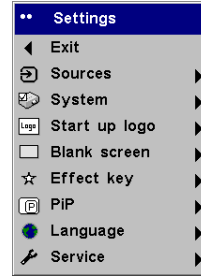

Settings menu

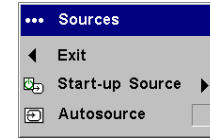

Sources

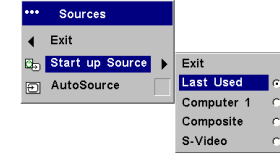

Startup Source

**System>Rear:** reverses the image so you can project from behind a translucent screen.

**Ceiling:** turns the image upside down for ceiling-mounted projection.

**Display Messages:** displays status messages (such as "Searching" or "Mute") in the lower-left corner of the screen.

**Power Save:** automatically turns the lamp off after no active sources are detected for 5 minutes. The LED blinks green for one minute while the fans continue to run to cool the lamp. If an active signal is received before the projector powers down, the image will be displayed. You must press the **Power** button to display an image after 10 minutes have passed. This feature also makes the projector go into the startup state after it is powered on, which allows you to turn ceiling mounted projectors on and off with a wall power switch. When Power Save is enabled, Screen Save is disabled.

**Screen Save:** to preserve lamp life, the projector automatically blanks the screen with a gray color after no signals are detected for 30 minutes. The image returns when an active source is detected or a remote or keypad button is pressed. If you turn Screen Save on, the gray screen appears after 5 minutes.

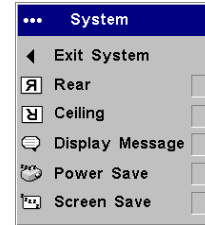

System menu

**Startup Logo:** allows you to display a blank black, white, or blue screen instead of the default screen at startup and when no source is detected.

**Blank Screen:** determines what color is displayed when you press the **Blank** button on the remote.

**Effect:** allows you to assign a different function to the **Effect** button on the remote, allowing you to quickly and easily use the effect. The default effect is About, which opens a window with projector and source information. Highlight an effect and press **Select** to choose a different one.

**Blank:** shows an empty screen.

**Mute:** turns off all sound.

**Aspect Ratio:** sets the ratio of the image width to image height. It toggles among 4:3, 16:9, and Native (page 26).

**Source:** cycles through the available sources.

**Auto Image:** causes computer sources to be reacquired.

**Freeze:** pauses the projected image. This is useful if you want to make changes on your computer without your audience seeing them.

**Zoom:** lets you magnify a part of the screen. To use the Zoom effect, press **Effect**, then press the remote's right mouse button to zoom the image, press the mouse left mouse button to decrease the magnification. You can use the cursor control to pan the image, displaying different parts of it (only if the image is magnified). To return to the original size and cancel Zoom, press the **Effect** button a second time.

**About:** is the default effect. It displays the About menu.

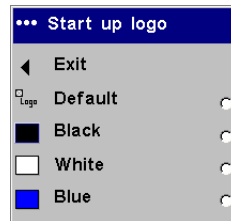

Startup Logo

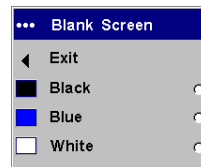

Blank screen



Effect

**PiP:** (Picture in Picture) allows you to overlay a smaller window showing the video source on top of the larger computer source window. You must have both a computer and video source connected to use PiP. You can't show a computer image in the smaller PiP window, only a video image. You can select a small, medium, or large window. You can also move the PiP window on the screen using the PiP Position X and Y options in the menu. Press the up and down arrows to change the position.

**Mask:** allows you to cover part of the image with a black curtain. Press the up and down arrows to raise or lower the curtain on the image.

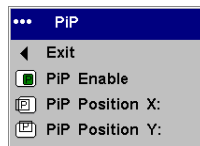

Picture in Picture

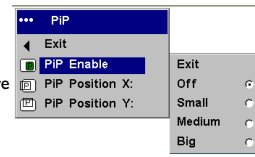

PIP size

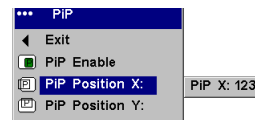

PIP Position

**Language:** allows you to select a language for the onscreen display.



Language

**Service:** provides projector and lamp service information.

**Factory Reset:** restores all settings to their default.

**Reset Lamp:** resets the lamp hours used counter in the About menu to zero. Do this only after changing the lamp.

**Service Info:** provides information about the projector's software version and the active source.

**Service Code:** only used by authorized service personnel.

**About:** provides information about the projector and the active source. Showing the About box is the default action assigned to the Effect button.



Service menu

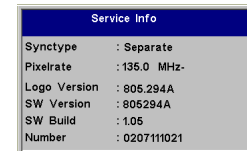

Service Info menu

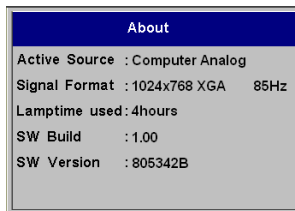

About menu





# Maintenance

## Cleaning the lens

- 1 Apply a non-abrasive camera lens cleaner to a soft, dry cloth.
  - Avoid using an excessive amount of cleaner, and don't apply the cleaner directly to the lens. Abrasive cleaners, solvents or other harsh chemicals might scratch the lens.
- 2 Lightly wipe the cleaning cloth over the lens in a circular motion. If you don't intend to use the projector immediately, replace the lens cap.

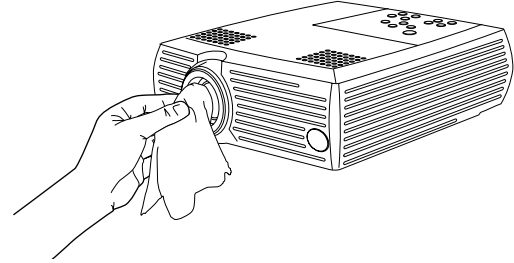

## Cleaning the dust filter

The dust filter catches dust and other particles in the air. If the filter becomes clogged, the projector does not cool properly and may malfunction.

- 1 Turn off the projector and unplug the power cord.
- 2 Turn the projector upside down, loosen the screw on the filter, then gently pry the filter up.
- 3 Clean the filter using a vacuum cleaner on low power.
- 4 Replace the filter and tighten the screw.

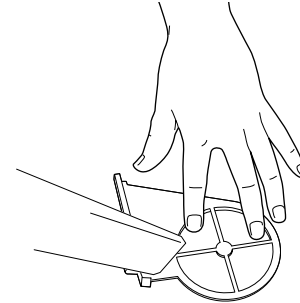
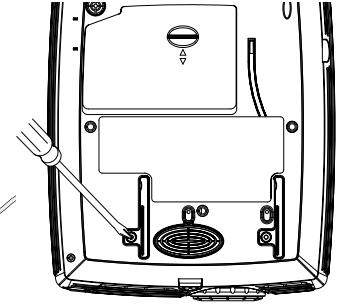
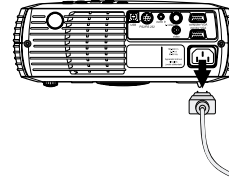

## Replacing the projection lamp

The lamp hours used timer in the About menu counts the number of hours the lamp has been in use. After 1980 hours, the message "Change lamp" appears on the screen at startup. When the timer reaches 2000 hours, the lamp will no longer light. You can order new lamp housings from your dealer. See "" on page 37 for information.

**NOTE:** Use only a replacement lamp with the same type and rating as the original lamp.

- 1 Turn off the projector and unplug the power cord.
- 2 Wait 60 minutes to allow the projector to cool thoroughly.

- 3 Turn the projector upside down and remove the lamp door by pushing the tab forward (toward the lens).

**CAUTION:** Never operate the projector with the lamp door removed. This disrupts the air flow and causes the projector to overheat.

- 4 Loosen the three captive screws on the lamp housing.

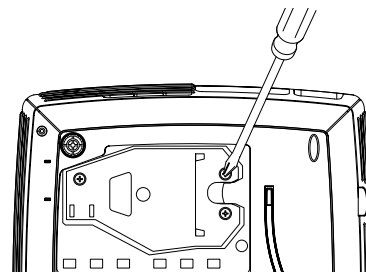
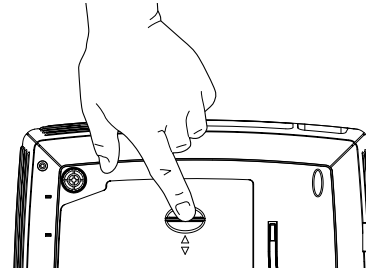
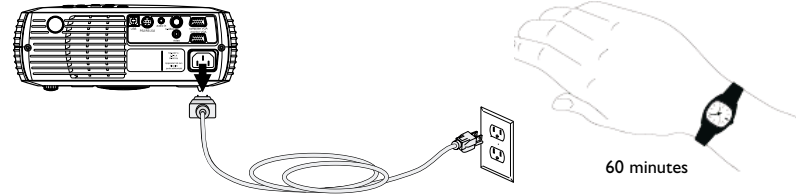
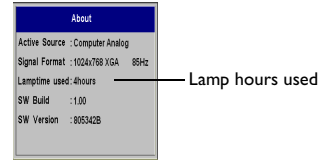

**WARNING:** To avoid burns, allow the projector to cool for at least 60 minutes before you replace the lamp.

**WARNING:** Do not drop the lamp module or touch the glass bulb! The glass may shatter and cause injury.

**WARNING:** Be extremely careful when removing the lamp housing. In the unlikely event that the bulb ruptures, small glass fragments may be generated. The lamp module is designed to contain these fragments, but use caution when removing the lamp module.

- 5 Carefully remove the lamp housing. Dispose of the lamp in an environmentally proper manner.
- 6 Install the new lamp housing and tighten the screws.
- 7 Replace the lamp door.
- 8 Plug in the power cord, press the **Power** button to turn the projector back on.
- 9 To reset the lamp hour timer, navigate to the **Settings>Service** menu and select Reset Lamp.

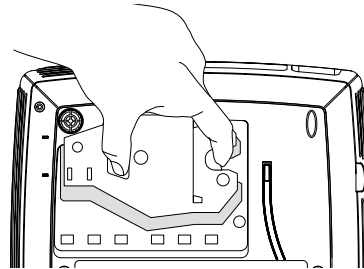

Reset Lamp

## **Cleaning the lamp housing screens**

In dirty or dusty environments, the dust filter screens in the lamp housing area in the C50 can become clogged, causing high temperatures and premature lamp failure (these screens are not present on the C40). Routine maintenance to remove dust from the screens lowers the lamp operating temperature and prolongs lamp life. To maximize lamp life you may want to clean the screen every 250 hours.

- 1** Remove the lamp module.
- 2** Examine the dust filter screens in the lamp housing area. If necessary, use a vacuum cleaner set on low power to clean the screens. Be careful not to disturb any internal components when cleaning the screens.
- 3** Replace the lamp module and lamp door.

## **Using the security lock**

The projector has a security lock for use with a PC Guardian Cable Lock System. See page 37 for ordering information. Refer to the information that came with the lock for instructions on how to use it.

# Appendix

## Specifications

<b>Temperature</b>	41 to 95° F (5 to 35° C) at sea level
Operating	
Non-operating	-4 to 140° F (-20 to 60° C)
<hr/>	
<b>Altitude</b>	0 to 10,000 feet (3,048 meters)
Operating	
Non-operating	0 to 20,000 feet (6,096 meters)
<hr/>	
<b>Humidity</b>	20% to 80% relative humidity, non-condensing
Operating	
Non-operating	10% to 90% relative humidity, non-condensing
<hr/>	
<b>Dimensions</b>	12 x 10 x 3.7" (305 x 255 x 95 mm)
<hr/>	
<b>Weight</b>	5.7 lbs. (2.6 kg) unpacked
<hr/>	
<b>Optics</b>	4.9 - 29 feet (1.5 - 8.9 m)
Focus Range	
Lamp type	132-watt UHP lamp for C40 150-watt UHP lamp for C50
<hr/>	
<b>Input Power Requirements</b>	100-240V 2.5-1 A, 50-60 Hz
<hr/>	
<b>Ceiling Mount</b>	UL tested/listed ceiling mount with minimum capacity of 23 lbs (10.4 kg)

## Accessories

<b>Standard Accessories (ship with the projector)</b>	<b>Part Number</b>
Soft Case	110-0563-xx
Computer Cable 6 ft (1.8 m)	301361B
Audio/Video Cable 6 ft (1.8 m)	301379B
Audio Cable	301398B
Power Cord (country-dependent)	300065
Remote	551-0054-xx
Projection Lamp Module (included in projector)	SP-LAMP-005 for C40 SP-LAMP-007 for C50
Lens Cap	340-1029-xx
SCART adapter	301130
Quick Setup card	009-0657-xx
User's Guide with CD	010-0363-xx
Safety card	009-0659-xx
Color-coded cable ties	SP-CABLETIES

**NOTE:** Use only approved accessories.

Optional Accessories	Part Number
Shipping Case (ATA approved)	CA-ATA-012
Samsonite Deluxe Travel Case	CASE-802
50" VGA Extension Solution	SP-VGAEXT50-D
Projector Mount	SP-CEIL-004
False Ceiling Plate	SP-LTMT-PLT
Mounting Extension Arm	SP-LTMT-EXTP
Projector Security Cable	SP-LOCK
50" Diagonal Screen (portable)	A650
60" Diagonal Screen (portable)	HW-DLXSCRN
84" Diagonal Wall/Ceiling Mounted Screen	HW-WALLSCR84
Portable Projector Stand	SP-STND
Replacement Lamp Module for C40	SP-LAMP-005
Replacement Lamp Module for C50	SP-LAMP-007
Presentation Remote	SP-PRESENTER
MindPath RF PocketPoint Remote	HW-RF-POCKTPNT
MindPath RF GyroPoint Remote	GYRO-RF

## Projected image size

**Table 2:**

**Range of distance to the screen for a given screen size for C40**

Diagonal Screen Size (inches/m)	Image Width (inches/m)	Distance to screen	
		Maximum distance (feet/m)	Minimum Distance (feet/m)
40/1	32/0.8	5.8/1.8	4.8/1.5
50/1.3	40/1	7.3/2.2	6/1.8
60/1.5	48/1.2	8.8/2.7	7.2/2.2
100/2.5	80/2	14.6/4.5	12/3.7
150/3.8	120/3.1	21.9/6.7	18/5.5
200/5.1	160/4.1	29.2/8.9	24/7.3

**Table 3:**

**Range of distance to the screen for a given screen size for C50**

Diagonal Screen Size (inches/m)	Image Width (inches/m)	Distance to screen	
		Maximum distance (feet/m)	Minimum Distance (feet/m)
40/1	32/0.8	5.7/1.7	4.8/1.5
50/1.3	40/1	7.2/2.2	6/1.8
60/1.5	48/1.2	8.7/2.7	7.2/2.2
100/2.5	80/2	14.5/4.4	12.1/3.7
150/3.8	120/3.1	21.8/6.6	18.1/5.5
200/5.1	160/4.1	29/8.8	24.2/7.4

# Index

## A

- A/V cable, connecting 10
- About menu 31
- accessories
  - included 5
  - ordering 37, 38
- activating laptop's external video 7
- Add New hardware Wizard 8
- adjusting
  - Brightness 26
  - Color 26
  - computer image 9
  - computer images 23
  - computer refresh rate 15
  - Contrast 26
  - distance to the screen 9
  - focus 9
  - height of projector 9
  - Keystone 9, 26
  - presentation features 23
  - Tint 26
  - video image 28
  - volume 12
  - zoom 9
- Advanced menu 28
- altitude limits 37
- Aspect Ratio 26, 30
- audio
  - connecting audio cable 6
  - using 22
- Auto Image 22, 30
- Autosource 29

## B

- Blank 30
- Brightness 26

## C

- cables
  - included 5
  - ordering 37, 38
- ceiling projection 29
- cleaning
  - dust filters 33
  - lamp housing screens 36
  - projection lens 33
- Color 26
- Color Temperature 28
- composite video 10
- computer
  - activating laptop's external video 7
  - adjusting refresh rate 15
  - displaying image 7
  - optimizing image 23
  - resolution, adjusting
    - computer display resolution 16
- connecting
  - audio cable 6
  - computer 6
  - monitor cable 6
  - mouse cables 6
  - video device 10
- contacting InFocus 20
- Contrast 26
- customer service contact information 20
- customizing the projector 24



## **D**

- desktop computer, viewing image on monitor 6
- Display Messages 29
- displaying
  - computer image 7
  - languages 31
  - onscreen menus 25
  - PiP 31
  - video image 11
- drivers, installing 8

## **E**

- Effect button 30
- elevator foot 9

## **F**

- Factory Reset 31
- filters, cleaning 33
- focussing the image 9
- Freeze 30

## **H**

- Horizontal/Vertical Position 28

## **I**

- image
  - adjusting 9
  - adjusting keystone 9
  - focussing 9
  - masking 31
  - optimizing 23, 24
  - troubleshooting 17
  - zooming 9

## **K**

- keypad buttons 22
- keystone, adjusting 9

## **L**

- lamp
  - ordering 37
  - replacing 34
- lamp housing screens, cleaning 36
- Language 31
- laptop computer, activating external video 7
- LED behavior 7, 13
- lens, cleaning 33
- leveling foot 9

## **M**

- Main menu 25
- maintenance 33
- Mask 31
- menus
  - About 31
  - Advanced 28
  - changing language 31
  - displaying 25
  - Picture 26
  - Settings 29
  - System 29
  - using 25
- messages, displaying 29
- monitor loop through 6
- mouse, connecting cables 6
- Mute 30

**P**

- Phase 28
- Picture in Picture 31
- Picture menu 26
- PiP 31
- Power button 22
- power cord, connecting 6
- Power Save 29
- powering on the projector 7
- presentation features 23
- Presets 27
- projecting from behind a wall 29
- projecting from the ceiling 29
- projector
  - adjusting height 9
  - adjusting keystone 9
  - components 5
  - connecting computer 6
  - customing 24
  - displaying computer image 7
  - first time use with Windows 98 8
  - keypad 22
  - leveling 9
  - maintaining 33
  - overview 5
  - registering 5
  - replacing the lamp 34
  - resetting 31
  - returning for service 20
  - security lock 36
  - shutting down 13
  - specifications 37
  - troubleshooting 13
  - turning on 7
  - warranty 20

- PS2 mouse, connecting 6

**R**

- ratio, aspect 26
- rear projection 29
- refresh rate 15
- registering your projector 5
- remote control
  - installing batteries 21
  - using 21
- replacing the projection lamp 34
- resetting the projector 31
- resolution
  - computer 16
  - projector 5
- Room Lighting 27

**S**

- Screen Save 29
- security lock 36
- Service Info 31
- Settings menu 29
- Sharpness 28
- shutting down the projector 13
- Source 30
- specification 37
- Startup Logo 30
- startup screen, troubleshooting 14
- Startup Source 29
- S-video cable, connecting 10
- System menu 29

## **T**

- Tint 26
- Tracking 28
- troubleshooting 13
- turning off the projector 13
- turning on the projector 7

## **U**

- USB mouse, connecting 6
- using the menus 25

## **V**

- video device, connecting 10
- video image
  - displaying 11
  - optimizing 24
- volume
  - adjusting 12

## **Z**

- zoom 9, 30

## Limited Warranty

InFocus Corporation (“InFocus”) warrants that the Projector (“Product”) purchased from InFocus, an InFocus distributor, or an InFocus reseller will conform to the manufacturer’s specifications and be free from defects in material or workmanship for the Warranty period provided below. InFocus does not warrant that the Product will meet the specific requirements of the end-user customer.

If the Product, which is the subject of this Limited Warranty, is defective in material or workmanship during the warranty period, InFocus, at its option, will REPAIR or REPLACE the Product.

All exchanged parts and products replaced under this Warranty will become property of InFocus. InFocus’ sole obligation is to supply (or pay for) all labor necessary to repair the Product found to be defective within the Warranty period and to repair or replace defective parts with new parts or, at the option of InFocus, serviceable used parts that are equivalent or superior to new parts performance.

**Limited Warranty Alternatives:** Subject to the Limitations, Exclusions and Disclaimers, InFocus Warrants as follows:

**2 Year Parts and Labor Product Warranty** - From the date of purchase, InFocus warrants that the Product will conform to the manufacturers’ specifications and be free from defects in material or workmanship for a period of two (2) years.

**1 Year Parts Only Accessory Warranty** - From the date of purchase, InFocus warrants that the customer replaceable and accessory products will conform to the manufacturers’ specifications and be free from defects in material or workmanship for a period of one (1) year.

**90 Day/500 Hour Replacement Lamp Warranty** - Lamp Products purchased in projectors or separately as replacements after the original projector purchase is Ninety (90) days or 500 hours, whichever comes first. During the Warranty period for the Product, InFocus warrants that Replacement lamps, which are purchased at the time of projector purchase, will have a 90-day or 500 hour warranty, whichever comes first, from the date the spare lamp is put into use.

## WARRANTY LIMITATION AND EXCLUSION

THIS WARRANTY SETS FORTH INFOCUS’ MAXIMUM LIABILITY FOR ITS PRODUCT. THIS WARRANTY EXTENDS ONLY TO PRODUCTS PURCHASED FROM INFOCUS OR AN INFOCUS AUTHORIZED RESELLER. InFocus shall have no further obligation under the foregoing Limited Warranty if the Product has been damaged due to abuse, misuse, neglect, smoke exposure (cigarette or otherwise), accident, unusual physical or electrical stress, unauthorized modifications (including use of an unauthorized mount), tampering, alterations, or service other than by InFocus or its authorized agents, causes other than from ordinary use or failure to properly use the Product in the application for which said Product was intended.

This Warranty excludes Product or accessory cleaning, repair, or replacement of plastics due to cosmetic damage and damage as a result of normal wear. Product repair outside of the terms of the Limited Warranty will be on a time and materials basis. Prolonged Product “demonstration” causes unusual Product wear and is not considered normal use under the terms of this Limited Warranty.

The Accessory Warranty covers the accessory item only and excludes normal wear. The Lamp Product Warranty excludes expected lamp degradation.

Remanufactured Products and Software Products are exempt from the foregoing Limited Warranty. Please refer to the appropriate Remanufactured Product Limited Warranty or Software Product Limited Warranty for applicable Warranty information.

## DISCLAIMER OF UNSTATED WARRANTIES

THE WARRANTY PRINTED ABOVE IS THE ONLY WARRANTY APPLICABLE TO THIS PRODUCT. ALL OTHER WARRANTIES, EXPRESS OR IMPLIED, INCLUDING, BUT NOT LIMITED TO, THE IMPLIED WARRANTIES OF MERCHANTABILITY AND FITNESS FOR PARTICULAR PURPOSE ARE DISCLAIMED. THERE ARE NO WARRANTIES THAT EXTEND BEYOND THE DESCRIPTION ON THE FACE HEREOF AND THE FOREGOING WARRANTY SHALL NOT BE EXTENDED, ALTERED OR VARIED EXCEPT BY WRITTEN INSTRUMENT SIGNED BY INFOCUS. SOME JURISDICTIONS DO NOT ALLOW LIMITATIONS ON HOW LONG AN IMPLIED WARRANTY MAY LAST, SO SUCH LIMITATIONS MAY NOT APPLY TO YOU.

## Limited Warranty Period

The Limited Warranty period commences on the date of purchase by the end-user customer for both the 2 year Product Warranty and the 1 year Accessory Warranty. These Limited Warranty provisions shall apply only to the end-user purchaser (first person or entity that purchased a new Product for personal or business use and not for the purpose of distribution or resale).

## To Be Eligible For Limited Warranty Coverage

Any person exercising a claim under this Limited Warranty must establish to the satisfaction of InFocus both the date of purchase and that the Product was purchased new. The sales receipt or invoice, showing the date of purchase of the Product or Accessory is the proof of the date of purchase.

## To Obtain Warranty Service

During the Limited Warranty period, to exercise this Limited Warranty, the purchaser must first contact 1) InFocus, 2) a service facility authorized by InFocus or 3) the place of original purchase.

InFocus Customer Service - 1-800-799-9911 or techsupport@infocus.com

For Warranty service, the purchaser will be advised to return or deliver the defective Product freight and all fees prepaid, to an InFocus Service Center or to a service facility authorized by InFocus. When returning Product to InFocus, a Return Material Authorization Number (RMA #) is required and must be clearly displayed on the outside of the shipping carton or a similar package affording an equal degree of protection. InFocus or the service facility authorized by InFocus will return the repaired/replaced Product freight prepaid to the purchaser.

Products returned for Warranty service must be accompanied by a written letter that: (i) explains the problem; (ii) provides proof of date of purchase; (iii) provides the dealer's name; and (iv) provides the model and serial number of the Product. Upon request of InFocus Corporation or an InFocus authorized repair center receiving the Product, proof of legal importation must accompany the warranty repair Product, otherwise the Product must be returned to the place of original purchase, to the manufacturer (Purchaser must bear all tax, duty and freight), or the Purchaser must bear charges for the warranty repair.

No repair or replacement of Product or part thereof shall extend the Limited Warranty period as to the entire Product. Warranty on the repair part and workmanship shall only be effective for a period of ninety (90) days following the repair or replacement of that part or the remaining period of the Product Limited Warranty which ever is greater.

## LIMITATION OF LIABILITY

IT IS UNDERSTOOD AND AGREED THAT INFOCUS' LIABILITY WHETHER IN CONTRACT, IN TORT, UNDER ANY WARRANTY, IN NEGLIGENCE OR OTHERWISE SHALL NOT EXCEED THE RETURN OF THE AMOUNT OF THE PURCHASE PRICE PAID BY PURCHASER AND UNDER NO CIRCUMSTANCES SHALL INFOCUS BE LIABLE FOR SPECIAL, INDIRECT, INCIDENTAL OR CONSEQUENTIAL DAMAGES OR LOST PROFITS, LOST REVENUES OR LOST SAVINGS. THE PRICE STATED FOR THE PRODUCTS IS A CONSIDERATION IN LIMITING INFOCUS' LIABILITY.

**Limitation on Bringing Action** - No action, regardless of form, arising out of the agreement to purchase the product may be brought by purchaser more than one year after the cause of action has accrued.

**Governing Law** - Any action, regardless of form, arising out of the agreement to purchase the product is governed by Oregon law.

**Mandatory Arbitration** - Any action, regardless of form, arising out of the agreement to purchase the product is subject to mandatory arbitration.

SOME JURISDICTIONS DO NOT ALLOW THE EXCLUSION OR LIMITATION OF INCIDENTAL OR CONSEQUENTIAL DAMAGES SO THE ABOVE LIMITATION OR EXCLUSION MAY NOT APPLY TO YOU. THIS LIMITED WARRANTY GIVES YOU SPECIFIC LEGAL RIGHTS, AND YOU MAY ALSO HAVE OTHER RIGHTS, DEPENDING ON JURISDICTION.