

myprojectorlamps.com

**The most trusted, dependable name
in projector lamp sales.**



<http://www.myprojectorlamps.com>



<http://www.myprojectorlamps.ca>



<http://www.myprojectorlamps.eu>

The following projector manual has not been modified or altered in any way.

Manual for

Acer Projector XD1150/XD1150D/
XD1250/XD1250D series

Disposal instructions

Do not throw this electronic device into the trash when discarding. To minimize pollution and ensure utmost protection of the global environment, please recycle it.



USA

For electronic products containing an LCD/CRT monitor or display, or a super high pressure mercury lamp:



Lamp(s) inside this product contain mercury and must be recycled or disposed of according to local, state or federal laws. For more information, contact the Electronic Industries Alliance at www.eiae.org. For lamp-specific disposal information, check www.lamprecycle.org.











Table of Contents

Table of Contents	1
Usage Notice	2
Precautions	2
Introduction	4
Product Features	4
Package Overview	5
Product Overview	6
Main Unit	6
Control Panel	7
Connection Ports	8
Remote Control	9
Installation	10
Connecting the Projector	10
Powering On/Off the Projector	11
Powering On the Projector	11
Powering Off the projector	12
Warning Indicator	12
Adjusting the Projected Image	13
Adjusting the Projector Image Height	13
Adjusting the Projector Zoom / Focus	14
Adjusting Projected Image Size	14
User Controls	15
Control Panel & Remote Control	15
On-Screen Display Menus	19
How to operate	19
Color (Computer/Video Mode)	20
Image (Computer/Video Mode)	22
Management (Computer/Video Mode)	24
Audio (Computer/Video Mode)	31
Timer (Computer/Video Mode)	32
Language(Computer/Video Mode)	33
Appendices	34
Troubleshooting	34
Replacing the lamp	38
Specifications	39
Compatibility Modes	40
Regulation & safety notices	41

Usage Notice

Precautions

Follow all warnings, precautions and maintenance as recommended in this user's guide to maximize the life of your unit.

-  **Warning-** Do not look into the projector's lens when the lamp is on. The bright light may hurt your eyes.
-  **Warning-** To reduce the risk of fire or electric shock, do not expose this product to rain or moisture.
-  **Warning-** Please do not open or disassemble the product as this may cause electric shock.
-  **Warning-** When changing the lamp, please allow unit to cool down, and follow all changing instructions.
-  **Warning-** This product will detect the life of the lamp itself. Please be sure to change the lamp when it shows warning messages.
-  **Warning-** Reset the "Lamp Hour Reset" function from the On Screen Display "Management" menu after replacing the lamp module (refer to page 26)
-  **Warning-** When switching the projector off, please ensure the projector completes its cooling cycle before disconnecting power.
-  **Warning-** Turn on the projector first and then the signal sources.
-  **Warning-** Do not use lens cap when projector is in operation.
-  **Warning-** When the lamp reaches the end of its life, it will burn out and may make a loud popping sound. If this happens, the projector will not turn back on until the lamp module has been replaced. To replace the lamp, follow the procedures listed under "Replacing the Lamp".

Usage Notice

Do:

- ❖ Turn off the product before cleaning.
- ❖ Use a soft cloth moistened with mild detergent to clean the display housing.
- ❖ Disconnect the power plug from AC outlet if the product is not being used for a long period of time.

Don't:

- ❖ Block the slots and openings on the unit provided for ventilation.
- ❖ Use abrasive cleaners, waxes or solvents to clean the unit.
- ❖ Use under the following conditions:
 - In extremely hot, cold or humid environments.
 - In areas susceptible to excessive dust and dirt.
 - Near any appliance that generates a strong magnetic field.
 - Place in direct sunlight.

Introduction

Product Features

This product is an XGA(XD1250/XD1250D)/SVGA(XD1150/XD1150D) single chip 0.55" DLP® projector. Outstanding features include:

- ◆ True XGA, 1024 x 768 addressable pixels (for XD1250/XD1250D)
True SVGA, 800 x 600 addressable pixels (for XD1150/XD1150D)
- ◆ Single chip DLP® technology
- ◆ NTSC3.58/NTSC4.43/PAL/SECAM and HDTV compatible (480i/p, 576i/p, 720p, 1080i)
- ◆ User friendly and powerful Acer Empowering key including: Acer eView Management, Acer eTimer Management and Acer eOpening Management.
- ◆ High-tech DVI connection for digital signal with HDCP function and supports 480p, 576p, 720p and 1080i (XD1150D/XD1250D)
- ◆ Full function remote control
- ◆ Advanced digital keystone correction and high quality full screen image re-scaling
- ◆ User friendly control panel
- ◆ SXGA+, SXGA compression and VGA, SVGA re-sizing (for XD1250/XD1250D)
SXGA, XGA compression and VGA re-sizing (for XD1150/XD1150D)
- ◆ Mac compatible

Introduction

Package Overview

This projector comes with all the items shown below. Check to make sure your unit is complete. Contact your dealer immediately if anything is missing.

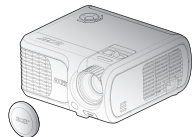

Projector with lens cap



Power Cord 1.8m



VGA Cable 1.8m



❖ (*): for XD1150D, XD1250D only.



Composite Video Cable
2.0m



S-Video Cable 1.8m (*)



VGA to Component/
HDTV Adapter (*)



USB Cable 1.8m (*)



Remote Control



2 x Battery



Carrying Case

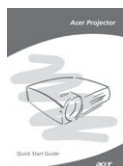

Quick Start Card



User's Guide

Introduction

Product Overview

Main Unit



❖ Two remote control receiver provided at front panel and front-top cover.

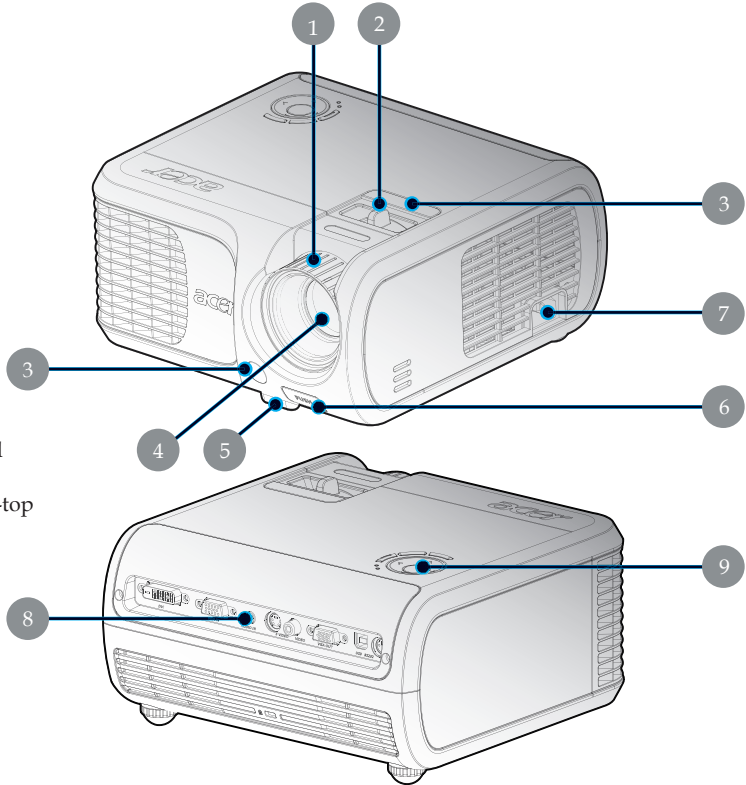

1. Focus Ring
2. Zoom Ring
3. Remote Control Receivers
4. Zoom Lens
5. Elevator Foot
6. Elevator Button
7. Power Socket
8. Connection Ports
9. Control Panel

Introduction

Control Panel

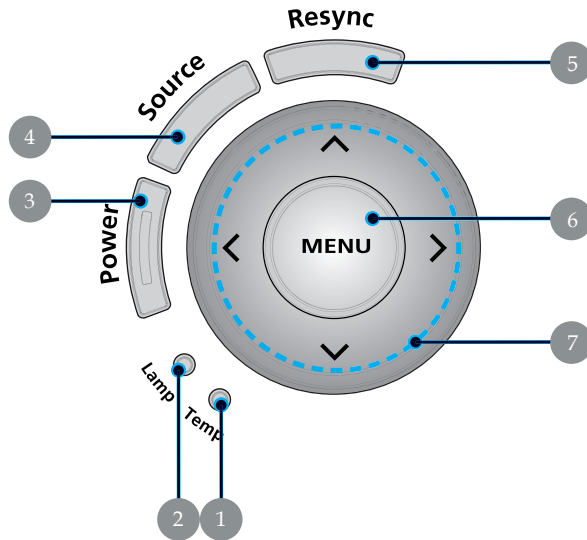

1. Temp Indicator LED
2. Lamp Indicator LED
3. Power and Indicator LED (Power LED)
4. Source
5. Resync
6. Menu
7. Four Directional Select Keys

Introduction

Connection Ports

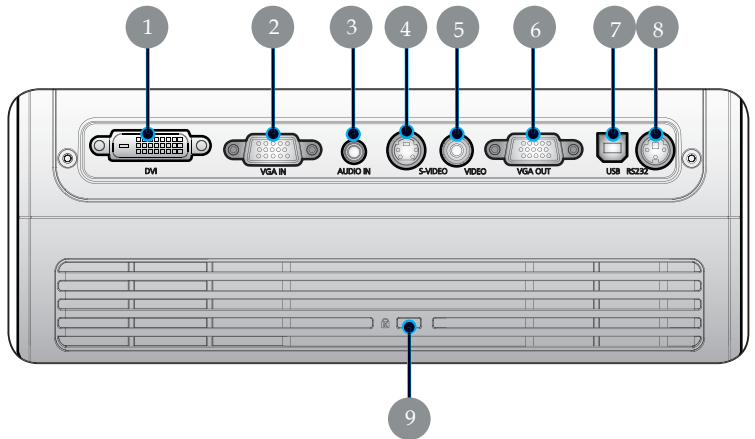

1. DVI Input Connector (for Digital signal with HDCP function) (*)
2. VGA Input Connector (PC Analog Signal/HDTV/Component Video)
3. Audio Input Connector (*)
4. S-Video Input Connector
5. Composite Video Input Connector
6. Monitor Loop-through Output Connector (VGA-Out) (*)
7. USB Connector
8. RS232 Connector (*)
9. Kensington™ Lock Port



❖ (*): for XD1150D/
XD1250D only.

Introduction

Remote Control

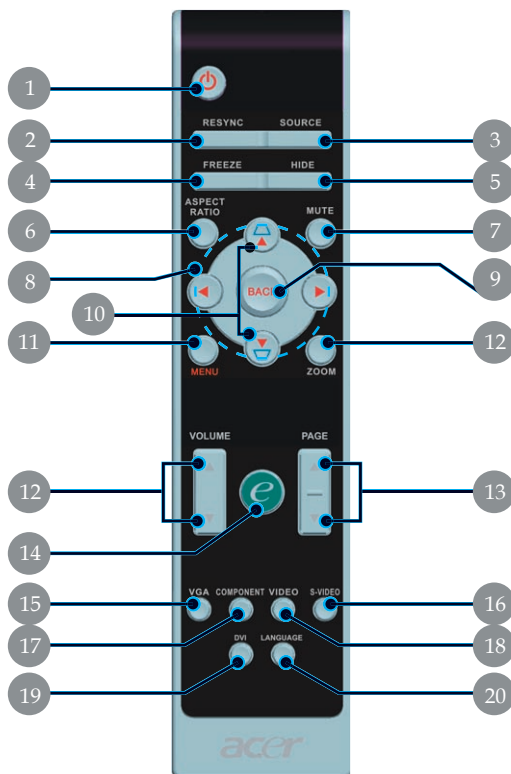

❖ (*): Do not support function for XD1150/ XD1250.

- | | |
|---------------------------------|---------------------|
| 1. Power | 14. Empowering Key |
| 2. Resync | 15. VGA |
| 3. Source | 16. S-Video |
| 4. Freeze | 17. Component Video |
| 5. Hide | 18. Composite Video |
| 6. Aspect Ratio | 19. DVI (*) |
| 7. Mute (*) | 20. Language |
| 8. Four Directional Select Keys | |
| 9. Back | |
| 10. Keystone +/- | |
| 11. Menu | |
| 12. Volume +/- (*) | |
| 13. Page Up/Page Down | |

Installation

Connecting the Projector



1. Power Cord
2. DVI Cable (Optional Accessory)
3. VGA Cable
4. Audio Cable Jack/Jack (Optional Accessory)
5. USB Cable (XD1150D/XD1250D)
6. RS232 Cable (Optional Accessory)
7. 3 RCA Component Cable (Optional Accessory)
8. VGA to Component/HDTV Adapter (XD1150D/XD1250D)
9. S-Video Cable (XD1150D/XD1250D)
10. Composite Video Cable

❖ *To ensure the projector works well with your computer, please make sure the timing of the display mode is compatible with the projector. Refer to the "Compatibility Modes" section on page 40.*

Installation

Powering On/Off the Projector

Powering On the Projector

1. Remove the lens cap. ❶
2. Ensure that the power cord and signal cable are securely connected. The Power LED will flash **red**.
3. Turn on the lamp by pressing “Power” button on the control panel. ❷ And the Power LED will turn **blue**.
4. Turn on your source (computer, notebook, video player ,etc.). The projector will detect your source automatically.

- ❖ *If the screen displays “Lock” & “Source” icons, it means the projector locks on this source type and there is no such type of input signal found.*
- ❖ *If the screen displays “No Signal”, please make sure the signal cables are securely connected.*
- ❖ *If you connect multiple sources at the same time, using the “Source” button on the remote control or control panel to switch.*

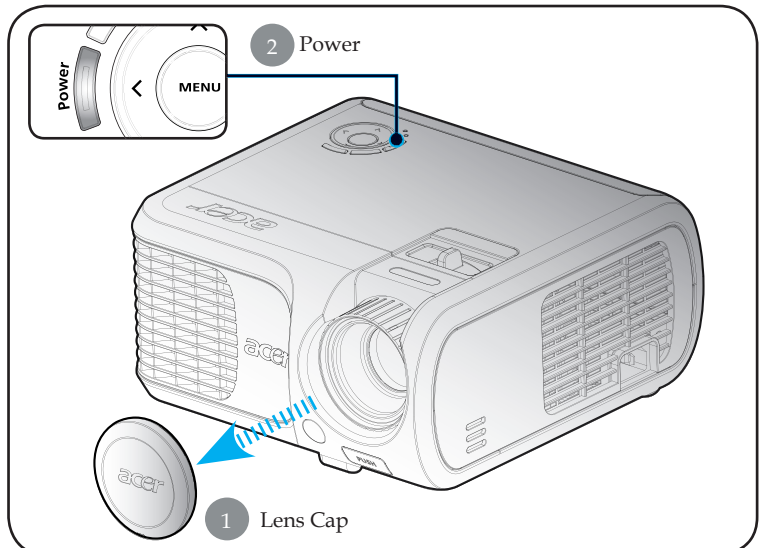

❖ Turn on the projector first and then the signal sources.

Powering Off the Projector

1. Press the "Power" button to turn off the projector lamp, you will see a message "Please press power button again to complete the shutdown process. Warning: DO NOT unplug while the projector fan is still running." displayed on the projector's screen. Press the "Power" button again to confirm, otherwise the message will disappear after 5 seconds.
2. The cooling fans continue to operate for about 30 seconds for cooling cycle and the Power LED will be quick **red flash**. When the Power LED becomes slow flashing, the projector has entered standby mode. If you wish to turn the projector back on, you must wait until the projector has completed the cooling cycle and has entered standby mode. Once in standby mode, simply press "Power" button to restart the projector.
3. Disconnect the power cord from the electrical outlet and the projector.
4. Do not turn on the projector immediately following a power off procedure.

Warning Indicator

- ❖ *When the "LAMP" indicator lights solid red, the projector will automatically shut itself down. Please contact your local reseller or service center.*
- ❖ *When the "TEMP" indicator lights solid red for about **20** seconds, it indicates the projector has been overheated. You will see a message "Projector Overheated. Lamp will automatically turn off soon." on the on-screen display. The projector will automatically shut itself down.*

Under normal conditions, the projector can be switched on again after it has cooled down. If the problem persists, you should contact your local dealer or our service center.

- ❖ *When the "TEMP" indicator flashes red for about **30** seconds, you will see a message "Fan fail. Lamp will automatically turn off soon." on the on-screen display. Please contact your local dealer or our service center.*

Installation

Adjusting the Projected Image

Adjusting the Projector Image Height

The projector is equipped with an elevator foot for adjusting the image height.

To raise the image:

1. Press the elevator button **1**.
2. Raise the image to the desired height angle **2** , then release the button to lock the elevator foot into position.

To lower the image:

1. Press the elevator button.
2. Lower the image, then release the button to lock the elevator foot into position.

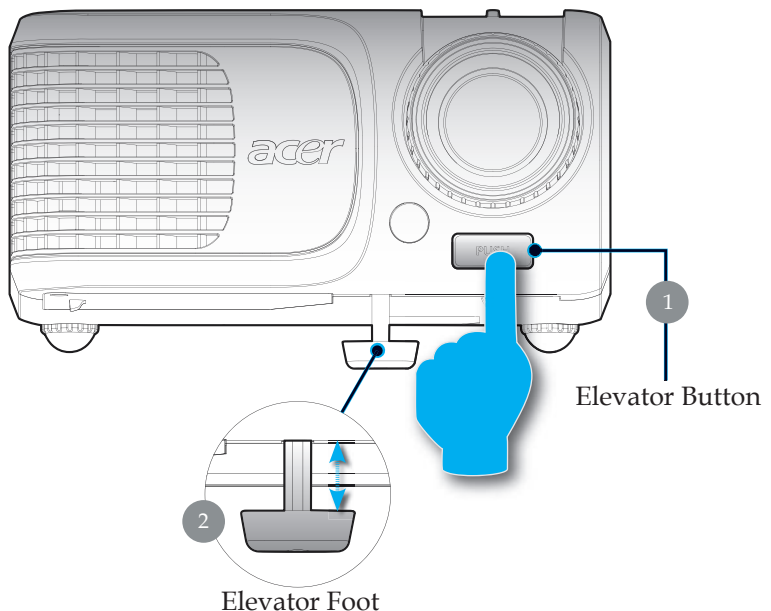

Installation

Adjusting the Projector Zoom / Focus

You may turn the zoom ring to zoom in or out. To focus the image, rotate the focus ring until the image is clear. The projector will focus at distances from 3.28 to 39.4 feet (1.0 to 12.0 meters).

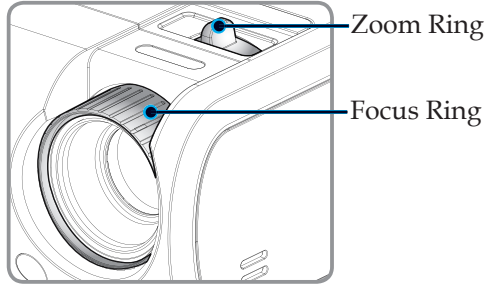

Adjusting Projection Image Size

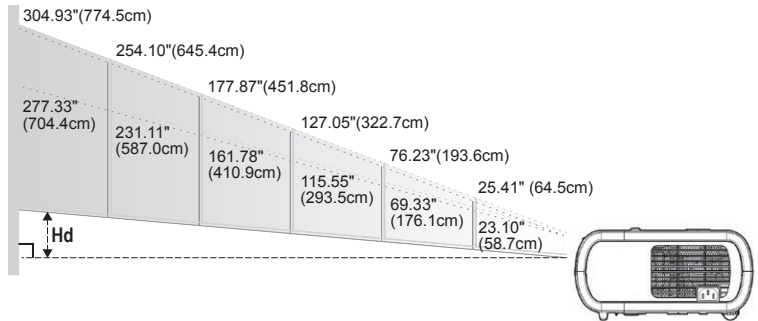

Screen (Diagonal)	Max.	25.41" (64.5cm)	76.23" (193.6cm)	127.05" (322.7cm)	177.87" (451.8cm)	254.10" (645.4cm)	304.93" (774.5cm)
	Min.	23.10" (58.7cm)	69.33" (176.1cm)	115.55" (293.5cm)	161.78" (410.9cm)	231.11" (587.0cm)	277.33" (704.4cm)
Screen size	Max. (WxH)	20.33" x 15.25" 51.6 x 38.7cm	60.98" x 45.74" 154.9 x 116.2cm	101.64" x 76.23" 258.2 x 193.6cm	142.30" x 106.72" 361.4 x 271.1cm	203.28" x 152.46" 516.3 x 387.2cm	243.94" x 182.96" 619.6 x 464.7cm
	Min. (WxH)	18.49" x 13.87" 47.0 x 35.2cm	55.46" x 41.60" 140.9 x 105.7cm	92.44" x 69.33" 234.8 x 176.1cm	129.42" x 97.07" 328.7 x 246.5cm	184.89" x 138.67" 469.6 x 352.2cm	221.86" x 166.40" 563.5 x 422.6cm
HD	Max.	2.29" (5.8cm)	6.86" (17.4cm)	11.43" (29.0cm)	16.01" (40.7cm)	22.87" (58.1cm)	27.44" (69.7cm)
	Min.	2.08" (5.3cm)	6.24" (15.9cm)	10.40" (26.4cm)	14.56" (37.0cm)	20.80" (52.8cm)	24.96" (63.4cm)
Distance		3.28' (1.0m)	9.84' (3.0m)	16.40' (5.0m)	22.97' (7.0m)	32.81' (10.0m)	39.37' (12.0m)

❖ This graph is for user's reference only.

User Controls

Control Panel & Remote Control

There are two ways for you to control the functions: Remote Control and Control Panel.

Control Panel

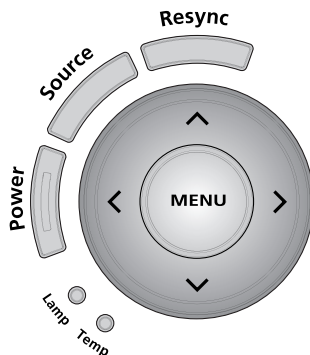

Using the Control Panel

Power

- ▶ Refer to the “Power On/Off the Projector” section on pages 11-12.

Resync

- ▶ Automatically synchronizes the projector to the input source.

Menu

- ▶ Press “Menu” to launch the on screen display (OSD) menu or back to previous step of OSD menu.

Source

- ▶ Press “Source” to choose RGB, Component-p, Component-i, S-Video, Composite, Video and HDTV sources.

Four Directional Select Keys

- ▶ Use to select items or make adjustments to your selection in OSD menu. Use for keystone correction to adjust image distortion caused by tilting the projector (± 16 degrees) while OSD menu is turned off.

User Controls

Remote Control



❖ (*): for XD1150D, XD1250D only.

Using the Remote Control

Power

- ▶ Refer to the “Power On/Off the Projector” section on pages 11-12

Resync

- ▶ Automatically synchronizes the projector to the input source.

Source

- ▶ Press “Source” to choose RGB, Component-p, Component-i, S-Video, Composite Video and HDTV sources.

Freeze

- ▶ Press “Freeze” to pause the screen image.

Hide

- ▶ Momentarily turns off the video. Press “Hide” to hide image, press again to restore display of the image.





Aspect Ratio

- ▶ Use this function to choose your desired aspect ratio. (Auto/4:3/16:9/480p)

Mute

- ▶ Use this key to close the volume.

Four Directional Select Keys

- ▶ Use     to select items or make adjustments to your selection for the OSD menu operation.

Keystone

- ▶ Adjusts image distortion caused by tilting the projector (± 16 degrees).

Menu ^(*)

- ▶ Press “Menu” to launch the on screen display menu or back to previous step of OSD menu.

Zoom

- ▶ Digital Zoom in/out.

Back

- ▶ Back to the previous step for the OSD menu operation.

User Controls



Empowering Key

Acer Empowering Key provides three Acer unique functions, they are “Acer eView Management”, “Acer eTimer Management” and “Acer eOpening Management” respectively. Press “e” key for more than one second to launch the on screen display main menu to modify its function.

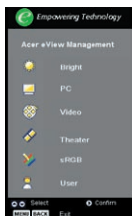

Acer eView Management

- ▶ Press “e” to launch “Acer eView Management” submenu.

“Acer eView Management” is for display mode selection. Please refer to On Screen Display Menus section for more detail.



Acer eTimer Management

- ▶ Press “e” to launch “Acer eTimer Management” submenu.

“Acer eTimer Management” provides the reminding function for presentation time control. Please refer to On Screen Display Menus section for more detail.

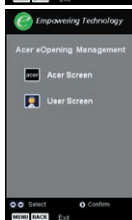

Acer eOpening Management

- ▶ Press “e” to launch “Acer eOpening Management” submenu.

“Acer eOpening Management” allows user to change the Startup screen to their personalized image. Please refer to On Screen Display section for details.



❖ (*): for XD1150D, XD1250D only.

Volume (*)

- ▶ Increase/decrease the volume.

Page Up (Computer mode only)

- ▶ Use this button to page up. This function is only available when the projector is connected to a computer via an USB cable.

Page Down (Computer mode only)

- ▶ Use this button to page down. This function is only available when the projector is connected to a computer via an USB cable.

User Controls

VGA

- ▶ Press “VGA” to change source to VGA-In connector. This connector supports Analog RGB, YPbPr (480p/576p/720p/1080i), YCbCr (480i/576i) and RGBsync.

Component Video

- ▶ Press “Component” to change source to component Video source. This source supports YPbPr (480p/576p/720p/1080i) and YCbCr (480i/576i)

Composite Video

- ▶ Press “Video” to change source to Composite Video source.

S-Video

- ▶ Press “S-Video” to change source to S-Video source.

DVI (*)

- ▶ Press “DVI” to change source to DVI connector. This connector supports Digital RGB, Analog RGB, YPbPr (480p/576p/720p/1080i), YCbCr (480i/576i) and HDCP signal.

Language

- ▶ Choose the multi-lingual OSD menu.



❖ (*): for XD1150D, XD1250D only.

User Controls

On Screen Display Menus

The Projector has multilingual On Screen Display menus that allow you to make image adjustments and change a variety of settings. The projector will automatically detect the source.

How to operate

1. To open the OSD menu, press “Menu” on the Remote Control or Control Panel.
2. When OSD is displayed, use ▲ ▼ keys to select any item in the main menu. After selecting the desired main menu item, press ► to enter sub menu for feature setting.
3. Use ▲ ▼ keys to select the desired item and adjust the settings by ◀ ▶ key.
4. Select the next item to be adjusted in the sub menu and adjust as described above.
5. Press “Menu” or “Back” on the Remote Control or Control Panel, the screen will return to the main menu.
6. To exit OSD, press “Menu” or “Back” on the Remote Control or Control Panel again. The OSD menu will close and the projector will automatically save the new settings.

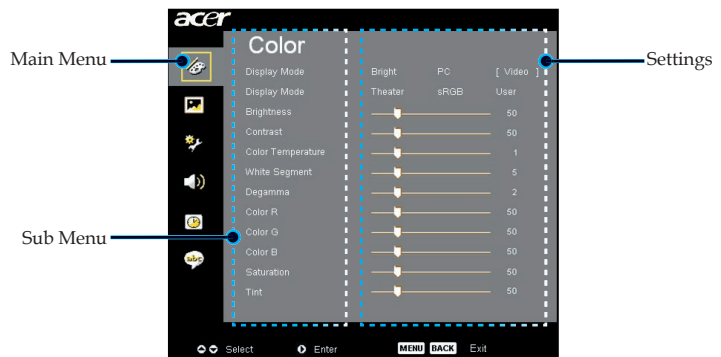

User Controls

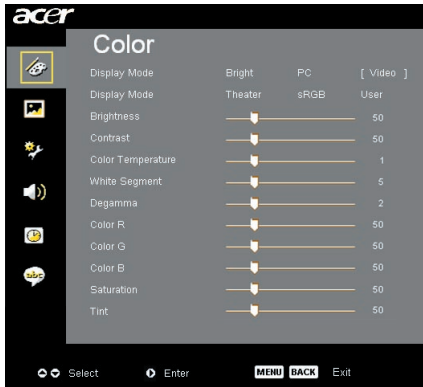

Color (Computer / Video Mode)

Display Mode

There are many factory presets optimized for various types of images.

- ▶ Bright : For brightness optimization.
- ▶ PC : For computer or notebook.
- ▶ Video : For playing video in a bright environment.
- ▶ Theater : For Home Theatre usage in a dark room.
- ▶ sRGB : For true-color optimization.
- ▶ User : Memorize user's settings.

Brightness

Adjust the brightness of the image.

- ▶ Press the ◀ to darken image.
- ▶ Press the ▶ to lighten the image.

Contrast

The contrast controls the degree of difference between the lightest and darkest parts of the picture. Adjusting the contrast changes the amount of black and white in the image.

- ▶ Press the ◀ to decrease the contrast.
- ▶ Press the ▶ to increase the contrast.

Color Temperature

Adjust the color temperature. At higher temperature, the screen looks colder; at lower temperature, the screen looks warmer.

User Controls

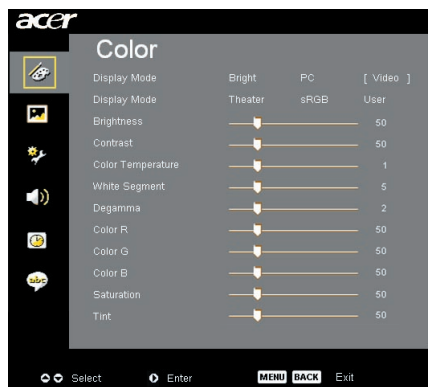

Color (Computer / Video Mode)

White Segment

Use the white Segment control to set the white peaking level of DMD chip. 0 stands for minimal segment, and 10 stands for maximum segment. If you prefer a stronger image, adjust towards the maximum setting. For a smooth and more natural image, adjust towards the minimum setting.

Degamma

Effects the represent of dark scenery. With greater gamma value, dark scenery will look brighter.

Color R

Adjusts the red color.

Color G

Adjusts the green color.

Color B

Adjusts the blue color.

Saturation

Adjusts a video image from black and white to fully saturated color.

- ▶ Press the ◀ to decrease the amount of color in the image.
- ▶ Press the ▶ to increase the amount of color in the image.

Tint

Adjusts the color balance of red and green.

- ▶ Press the ◀ to increase the amount of green in the image.
- ▶ Press the ▶ to increase the amount of red in the image.



❖ “Saturation” and “Tint” functions are not supported under computer mode or DVI mode.

User Controls

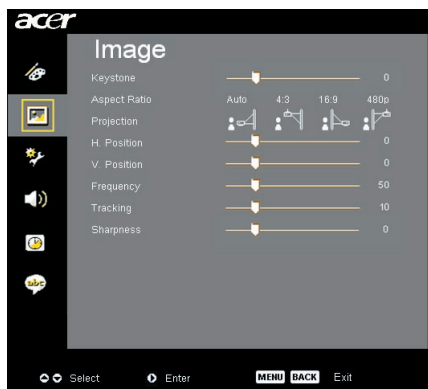

Image (Computer / Video Mode)

Keystone

- ▶ Adjust image distortion caused by tilting projection. (± 16 degrees)

Aspect Ratio



Use this function to choose your desired aspect ratio.

- ▶ Auto : Keep the image with original width-high ratio and maximize the image to fit native horizontal or vertical pixels.
- ▶ 16:9 : The input source will be scaled to fit the width of the screen and narrowed the height to make the displayed image becomes 16:9 ratio.
- ▶ 4:3 : The input source will be scaled to fit the projection screen and becomes 4:3 ratio.
- ▶ 480p (*) : Provide the best display for a 480p 16:9 signal.



❖ (*): for XD1150/
XD1150D only.

Projection

- ▶  **Front-Desktop**
The factory default setting.
- ▶  **Front-Ceiling**
When you select this function, the projector turns the image upside down for ceiling-mounted projection.
- ▶  **Rear-Desktop**
When you select this function, the projector reverses the image so you can project behind a translucent screen.

User Controls

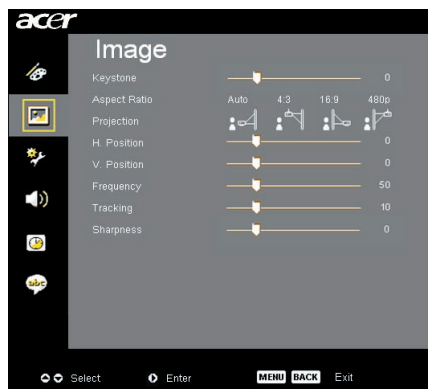

Image (Computer / Video Mode)



❖ “H. Position”, “V. Position”, “Frequency” and “Tracking” functions are not supported under DVI and Video mode.



Rear-Ceiling

When you select this function, the projector reverses and turns the image upside down at same time. You can project from behind a translucent screen with ceiling mounted projection.

H. Position (Horizontal Position)

- ▶ Press the ◀ to move the image left.
- ▶ Press the ▶ to move the image right.

V. Position (Vertical Position)

- ▶ Press the ◀ to move the image down.
- ▶ Press the ▶ to move the image up.

Frequency

“Frequency” changes the display data frequency to match the frequency of your computer’s graphic card. If you experience a vertical flickering bar, use this function to make an adjustment.

Tracking

“Tracking” synchronizes the signal timing of the display with the graphic card. If you experience an unstable or flickering image, use this function to correct it.

Sharpness

Adjusts the sharpness of the image.

- ▶ Press the ◀ to decrease the sharpness.
- ▶ Press the ▶ to increase the sharpness.



❖ “Sharpness” functions is not supported under VGA connector source.

User Controls



Management (Computer / Video Mode)

Auto Shutdown (Minutes)

The projector will auto shutdown while there is no signal input after the setting time.

Source Lock

When source lock is turned off, the projector will search for other signals if the current input signal is lost. When source lock is turned on, it will “Lock” the current source channel before you press “Source” button on remote control for next channel.

Menu Location

Choose the Menu location on the display screen.

Startup Screen

Use this function to select your desired startup screen. If you change the setting from one to another, when you exit the OSD menu, the new setting will take effect.

- ▶ Acer : The default startup screen of Acer projector.
- ▶ User : The user customized startup screen, which is downloaded from PC to projector via the USB cable and *Acer eOpening Management* utility (refer to the description of below section).

User Controls



Management (Computer / Video Mode)

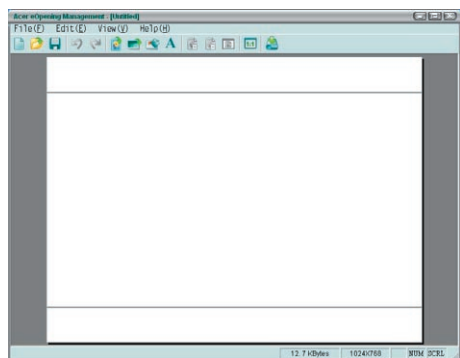

Acer eOpening Management is a PC utility for user to change the default startup screen of Acer projector to their desired image. You can install *Acer eOpening Management* from the bundled CD. Connect the projector to your PC with the bundled USB cable then execute *Acer eOpening Management* utility to download your desired image from your PC to projector. Before the download starts, the projector must enter "Download Mode" first. Please follow the instruction below to enter "Download Mode".

1. If the projector was turned on, press power button twice to turn off the projector.
2. Unplug the AC power cord from the projector.
3. Press and hold "Menu" and "⏻" buttons simultaneously then plug the AC power cord to the projector.
4. When Temp and Lamp LEDs are turned light, release both buttons, projector enters download mode.
5. Please make sure the USB cable has been connected to the projector from your PC.

Lamp Hour Elapse

Displays the lamp's elapsed operating time (in hours).



Lamp Reminding

Choose this function to show or to hide warning message when the changing lamp message is displayed. The message will show up 30 hours before end of life.

User Controls



Management (Computer / Video Mode)



Lamp Hour Reset

Press the button after choosing "Yes" to turn the lamp hour counter to 0 hours.

Security

Press to start "Security" setting. You must enter "Administrator Password" first before Security setting.

Security

This projector provides an excellent security function for the administrator to manage the usage of the projector.

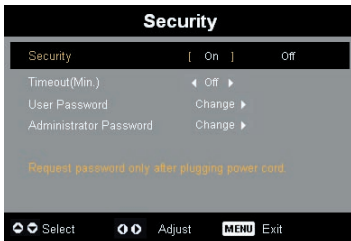

- ▶ Select "On" to enable the security function. User have to enter password depending on the "Security Mode" defined while setting "User Password". Please refer to "User Password" section for details.
- ▶ Select "Off" then user can switch on the projector without password request.

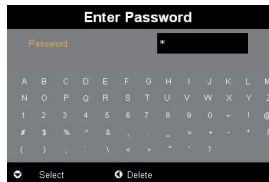

Once the security function is enabled, the projector will request user to enter password when switch on the projector. Both "User Password" and "Administrator Password" can be accepted for this dialogue.

Timeout(Min.)

User Controls



Management (Computer / Video Mode)

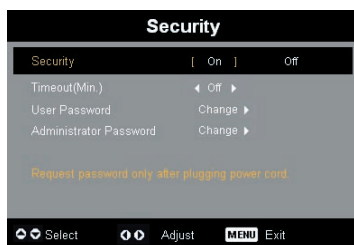

Once “Security” is set to “On”, administrator can set timeout function.

- ▶ Press ◀ or ▶ to select timeout duration.
- ▶ The range is from 10 minutes to 990 minutes.
- ▶ When time is up, the projector will request user to enter password again.
- ▶ The factory default setting of “Timeout(Min.)” is “Off”.

User Password

- ▶ Press ▶ to set up or change “User Password”.

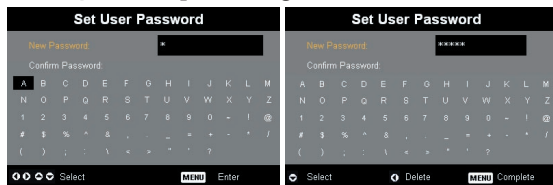

- ▶ Use ▲, ▼, ◀ or ▶ to select the character and press “MENU” to confirm.
- ▶ Press ◀ to delete character after the selected character confirmed.
- ▶ Press “MENU” to complete the setting of password.
- ▶ Input password again at “Confirm Password”.
- ▶ The password is allowed for 4~8 characters.

User Controls



Management (Computer / Video Mode)

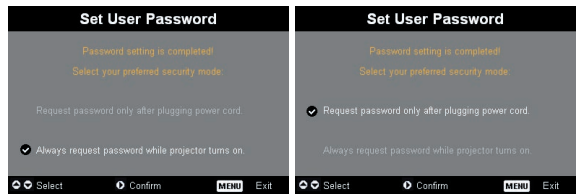

The projector provide two options of “Security Mode”.

- ▶ Select “Request password only after plugging power cord”, the project will request user to input password only for the first time plugging on power cord of the projector.
- ▶ Select “Always request password while projector turns on”, user have to input password every time when switching on the projector.

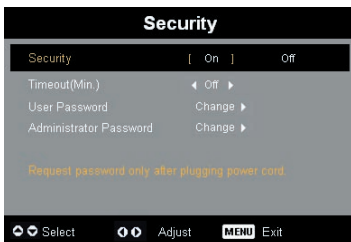

Administrator Password

“Administrator Password” can be accepted by both “Enter Administrator Password” and “Enter Password” dialogues.

- ▶ Press **Enter** to change “Administrator Password”.



- ▶ The factory default of “Administrator Password” is “1234”.

User Controls



Management (Computer / Video Mode)

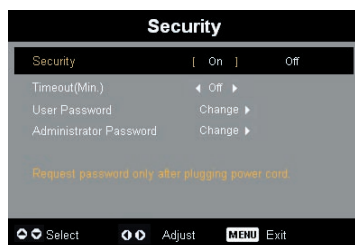

If administrator forgot "Administrator Password", do the following to retrieve the "Administrator Password":

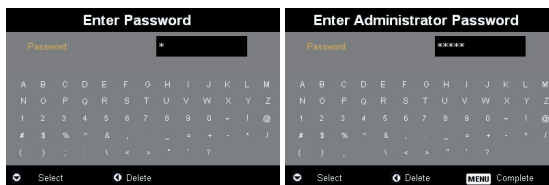

1. Press "MENU" for more than 4 seconds when any of "Enter Password" or "Enter Administrator Password" dialogue is currently displayed.

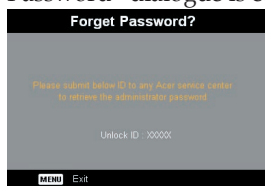

2. Write down the "Unlock ID" and contact with Acer service center. They will give you new Administrator Password according to the Unlock ID.
3. Once the new "Administrator Password" retrieved from Acer has been logged into the projector, old "Administrator Password" will be replaced by the new password.

User Controls



Management (Computer / Video Mode)



Reset

Press the  button after choosing "Yes" to return the display parameters on all menus to the factory default settings.

User Controls



Audio (Computer / Video Mode)

Volume

- ▶ Press the ◀ to decrease the volume.
- ▶ Press the ▶ to increase the volume.

Mute

- ▶ Choose the "On" to turn mute on.
- ▶ Choose the "Off" to turn mute off.

Power On/Off Volume

Choose this function to adjust volume when power on/off.

Alarm Volume

Choose this function to adjust volume when there are errors of the projector.



❖ Audio menu is for XD1150D/XD1250D.

User Controls



Timer (Computer / Video Mode)

Timer Start

Press the  to start/stop timer.

Timer Period

Press the  to adjust timer period.

Timer Volume (*)

Choose this function to adjust volume when timer function is enable and time is up.

Timer Display

Press the  to choose timer display mode on the screen.

Timer Location

Choose the timer location on the screen.





❖ (*): for XD1150D/
XD1250D only.

User Controls



Language (Computer / Video Mode)

Language

Choose the multilingual OSD menu . Use the  or  key to select your preferred language.

Press  to confirm the selection

Appendices

Troubleshooting

If you experience trouble with the projector, refer to the following information. If the problem persists, please contact your local reseller or service center.

Problem: No image appears on screen.

- ▶ Ensure all the cables and power connections are correctly and securely connected as described in the "Installation" section.
- ▶ Ensure the pins of connectors are not crooked or broken.
- ▶ Check if the projection lamp has been securely installed. Please refer to the "Replacing the lamp" section.
- ▶ Make sure you have removed the lens cap and the projector is switched on.
- ▶ Ensure that the "Hide" feature is not enabled.

Problem: Partial, scrolling or incorrectly displayed image.

- ▶ Press the "Resync" button on the Remote Control.
- ▶ If you use a PC:
If the resolution of your computer is higher than 1024 x 768 (XD1250, XD1250D)/800 x 600 (XD1150, XD1150D). Follow the steps outlined below to reset the resolution.

For Windows 3.x:

1. In the Windows Program Manager, click the "Windows Setup" icon in the Main group.
2. Verify that your display resolution setting is less than or equal to 1024 x 768 (XD1250, XD1250D)/800 x 600 (XD1150, XD1150D).

For Windows 95, 98, 2000, XP:

1. Open "My Computer" icon, the "Control Panel" folder, and then double click on the "Display" icon.
2. Select the "Setting" tab.
3. In the "Desktop Area" you will find the resolution setting. Verify that the resolution setting is less than or equal to 1024 x 768 (XD1250, XD1250D)/800 x 600 (XD1150, XD1150D) resolution.

If the projector is still not projecting the whole image, you will also need to change the monitor display you are using. Refer to the following steps.

4. Follow the above steps 1-2. Click on the "Advanced Properties" button.
5. Select the "Change" button under the "Monitor" tab.

Appendices

6. Click on "Show all devices". Then select "Standard monitor types" under the "Manufacturers" box ; choose the resolution mode you need under the "Models" box.
7. Verify that the resolution setting of the monitor display is less than or equal to 1024 x 768 (XD1250/XD1250D)/800 x 600 (XD1150/XD1150D).
 - ▶ If you are using a Notebook PC:
 1. You are required to implement the above steps of resolution setting of the computer first.
 2. Switch the Notebook PC display to the "external display only" or "CRT only" mode.
 - ▶ If you experience difficulty in changing resolutions or your monitor freezes, restart all the equipment and the projector.

Problem: The screen of the Notebook or PowerBook computer is not displaying your presentation.

- ▶ If you are using a Notebook PC:
Some Notebook PCs may deactivate their screens when a second display device is in use. Refer to your computer's documentation for information on how to reactivate the monitor display.
- ▶ If you are using an Apple PowerBook:
In Control Panels, open the PowerBook Display to select Video Mirroring "On".

Problem: Image is unstable or flickering

- ▶ Use "Tracking" to correct it. Refer to page 23.
- ▶ Change the monitor color setting from your computer.

Problem: Image has vertical flickering bar

- ▶ Use "Frequency" to make an ad adjustment. Refer to page 23.
- ▶ Check and reconfigure the display mode of your graphic card to make it compatible with the product. Refer to page 40.

Problem: Image is out of focus

- ▶ Adjusts the Focus Ring on the projector lens. Refer to page 14.
- ▶ Make sure the projection screen is between the required distance 3.28 to 39.4 feet (1.0 to 12.0 meters) from the projector.

Appendices

Problem: The image is outstretched when displaying 16:9 DVD.

The projector automatically detects 16:9 DVD and adjusts the aspect ratio by digitizing to full screen with 4:3 default setting.

If the image is still outstretched, you will also need to adjust the aspect ratio by referring to the following:

- ▶ Please select 4:3 aspect ratio type on your DVD player if you are playing a 16:9 DVD.
- ▶ If you can't select 4:3 aspect ratio type on your DVD player, please select 4:3 aspect ratio in the on screen menu.

Problem: Image is reversed.

- ▶ Select "Image" from the OSD and adjust the projection direction. See page 22.

Problem: Lamp burns out or makes a popping sound

- ▶ When the lamp reaches its end of life, it will burn out and may make a loud popping sound. If this happens, the projector will not turn on until the lamp module has been replaced. To replace the lamp, follow the procedures in the "Replacing the Lamp". See page 38.

Problem: LED lighting message

Message	Power LED		Temp LED	Lamp LED
	Red	Blue		
Standby State (Input power cord)	Slow Flashing	○	○	○
Lamp lighting	○	☀	○	○
Power on	○	☀	○	○
Power off (Cooling)	Quick Flashing	○	○	○
Error (Lamp fail)	○	○	○	☀
Error (Thermal fail)	○	○	☀	○
Error (Fan lock fail)	○	○	Flashing	○
Error (Over Temp.)	○	○	☀	○
Error (Lamp Breakdown)	○	○	○	☀



☀ =>Light On

○ =>Light Off

Appendices

Problem: Message Reminders

- ▶ “Lamp is approaching the end of its useful life in full power operation. Replacement Suggested!” will be shown about 10 seconds when lamp life is going to deplete.
- ▶ “Projector Overheated. Lamp will automatically turn off soon.” will be shown when the system temperature is over heat.
- ▶ “Fan fail. Lamp will automatically turn off soon.” will be shown when the fan is out of order.

Appendices

Replacing the lamp

The projector will detect the lamp life itself. It will show you a warning message "Lamp is approaching the end of its useful life in full power operation. Replacement Suggested!" When you see this message, changing the lamp as soon as possible. Make sure the projector has been cooled down for at least 30 minutes before changing the lamp.



Warning: Lamp compartment is hot! Allow it to cool down before changing lamp!

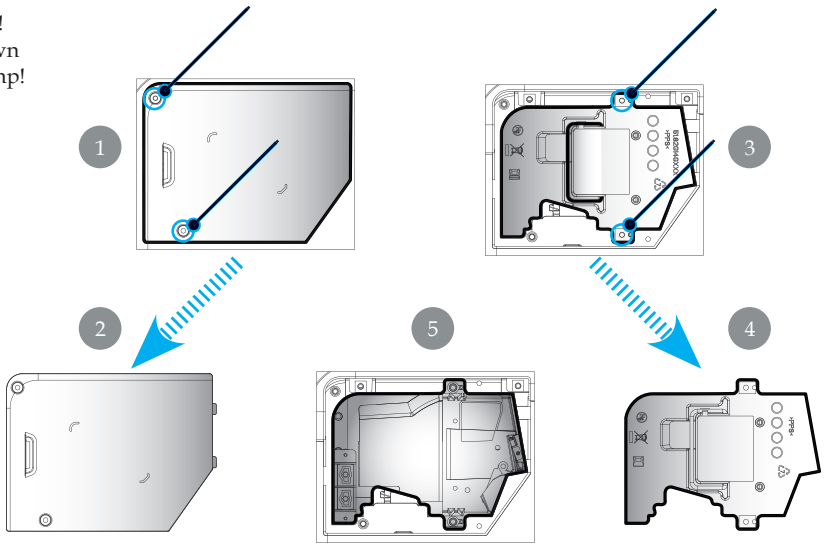

Warning: To reduce the risk of personal injury, do not drop the lamp module or touch the lamp bulb. The bulb may shatter and cause injury if it is dropped.

Lamp Changing Procedure:

1. Turn the power off the projector by pressing the Power button.
2. Allow the projector to cool down at least 30 minutes.
3. Disconnect the power cord.
4. Use a screwdriver to remove the screw from the cover. **1**
5. Push up and remove the cover. **2**
6. Remove the 2 screws from the lamp module. **3**
7. Pull out the lamp module. **4**

To replace the lamp module, reverse the previous steps.

Appendices

Specifications

The specs specified below are subject to change without notice. Regarding the final specs, please refer to Acer announced marketing specs.

Light Valve	- Single Chip DLP® Technology by Texas Instruments
Lamp	- 180W User Replaceable Lamp
Number of Pixels	- 1024 pixels(H) X 768 lines(V) for XD1250/XD1250D - 800 pixels(H) X 600 lines(V) for XD1150/XD1150D
Displayable Color	- 16.7M colors
Contrast Ratio	- 2100:1 (Full On/Full Off)
Uniformity	- 90%
Noise Level	- 31dB(A)
Projection Lens	- F/2.35~2.47 f=21.83~23.81mm with 1.1X Manual zoom lens
Projection Screen Size (Diag.)	- 23.1 to 302.0 inches / 0.59 to 7.68 m Diagonal
Projection Distance	- 3.28 to 39.4 feet (1.0 to 12.0 meters)
Video Compatibility	- NTSC 3.58/NTSC 4.43/PAL/SECAM and HDTV compatible - Composite video & S-Video capability
H. Frequency	- 31.5kHz~100kHz horizontal scan
V. Frequency	- 56Hz~85Hz vertical refresh
Power Supply	- Universal AC input 100-240V ; Input Frequency 50/60Hz
I/O Connectors	- Power: AC power input socket - VGA Input: ▪ One DVI connector for Digital signal with HDCP (for XD1150D/XD1250D) ▪ One 15-pin D-sub for VGA, component and HDTV signal - VGA Output: One 15-pin D-sub for VGA output (for XD1150D/XD1250D) - Video Input: ▪ One Composite video RCA input ▪ One S-Video input - RS232: One RS232 connector (for XD1150D/XD1250D) - USB: One USB connector
Weight	- 4.78 lbs (2.17kg)
Dimensions (W x H x D)	- 9.1 x 9.4 x 4.8 inches (230 x 238 x 122.8 mm)
Environmental	- Operating Temperature: 41~95 °F (5~35 °C) Humidity: 80% maximum (Non-condensing) - Storage Temperature: -4~140 °F (-20~60 °C) Humidity: 80% maximum (Non-condensing)
Safety Regulation	- FCC Class B, CE, VCCI, UL, cUL, TÜV-GS, PSE, CB Report, CCC

Appendices

Compatibility Modes

Mode	Resolution	(ANALOG)	
		V.Frequency (Hz)	H.Frequency (kHz)
VESA VGA	640 x 350	70	31.5
VESA VGA	640 x 350	85	37.9
VESA VGA	640 x 400	85	37.9
VESA VGA	640 x 480	60	31.5
VESA VGA	640 x 480	72	37.9
VESA VGA	640 x 480	75	37.5
VESA VGA	640 x 480	85	43.3
VESA VGA	720 x 400	70	31.5
VESA VGA	720 x 400	85	37.9
VESA SVGA	800 x 600	56	35.2
VESA SVGA	800 x 600	60	37.9
VESA SVGA	800 x 600	72	48.1
VESA SVGA	800 x 600	75	46.9
VESA SVGA	800 x 600	85	53.7
VESA XGA	1024 x 768	60	48.4
VESA XGA	1024 x 768	70	56.5
VESA XGA	1024 x 768	75	60.0
VESA XGA	1024 x 768	85	68.7
VESA SXGA	1152 x 864	70	63.8
VESA SXGA	1152 x 864	75	67.5
(*) VESA SXGA	1152 x 864	85	77.1
VESA SXGA	1280 x 1024	60	63.98
(*) VESA SXGA	1280 x 1024	75	79.98
(*) VESA SXGA+	1400 x 1050	60	63.98
MAC LC 13"	640 x 480	66.66	34.98
MAC II 13"	640 x 480	66.68	35
MAC 16"	832 x 624	74.55	49.725
MAC 19"	1024 x 768	75	60.24
MAC	1152 x 870	75.06	68.68
MAC G4	640 x 480	60	31.35
i MAC DV	1024 x 768	75	60
i MAC DV	1152 x 870	75	68.49
(*) i MAC DV	1280 x 960	75	75



❖ (*): for XD1250/
XD1250D only.

Appendices

Regulation & safety notices

This appendix lists the general notices of your Acer Projector.

FCC notice

This device has been tested and found to comply with the limits for a Class B digital device pursuant to Part 15 of the FCC rules. These limits are designed to provide reasonable protection against harmful interference in a residential installation. This device generates, uses, and can radiate radio frequency energy and, if not installed and used in accordance with the instructions, may cause harmful interference to radio communications.

However, there is no guarantee that interference will not occur in a particular installation. If this device does cause harmful interference to radio or television reception, which can be determined by turning the device off and on, the user is encouraged to try to correct the interference by one or more of the following measures:

- Reorient or relocate the receiving antenna.
- Increase the separation between the device and receiver.
- Connect the device into an outlet on a circuit different from that to which the receiver is connected.
- Consult the dealer or an experienced radio/television technician for help.

Notice: Shielded cables

All connections to other computing devices must be made using shielded cables to maintain compliance with FCC regulations.

Caution

Changes or modifications not expressly approved by the manufacturer could void the user's authority, which is granted by the Federal Communications Commission, to operate this computer.

Appendices

Operation conditions

This device complies with Part 15 of the FCC Rules. Operation is subject to the following two conditions:

1. this device may not cause harmful interference, and
2. this device must accept any interference received, including interference that may cause undesired operation.

Notice: Canadian users

This Class B digital apparatus complies with Canadian ICES-003.

Remarque à l'intention des utilisateurs canadiens

Cet appareil numérique de la classe B est conforme à la norme NMB-003 du Canada.

Declaration of Conformity for EU countries

Hereby, Acer, declares that this Acer projector is in compliance with the essential requirements and other relevant provisions of Directive 1999/5/EC. (Please visit <http://global.acer.com>.)

Compliant with Russian regulatory certification



ME61

Appendices

Important safety instructions

Read these instructions carefully. Save them for future reference.

1. Follow all warnings and instructions marked on the product.
2. Unplug this product from the wall outlet before cleaning. Do not use liquid cleaners or aerosol cleaners. Use a water-moistened cloth for cleaning.
3. Do not use this product near water.
4. Do not place this product on an unstable cart, stand or table. If the product falls, it could be seriously damaged.
5. This product should be operated from the type of power indicated on the marking label. If you are not sure of the type of power available, consult your dealer or local power company.
6. Do not allow anything to rest on the power cord. Do not locate this product where people will walk on the cord.
7. Never push objects of any kind into this product through cabinet slots as they may touch dangerous voltage points or short-out parts that could result in a fire or electric shock. Never spill liquid of any kind onto or into the product.
8. Do not attempt to service this product yourself, as opening or removing covers may expose you to dangerous voltage points or other risks. Refer all servicing to qualified service personnel.
9. Unplug this product from the wall outlet and refer servicing to qualified service personnel under the following conditions:
 - a. When the power cord or plug is damaged or frayed.
 - b. If liquid has been spilled into the product.
 - c. If the product has been exposed to rain or water.
 - d. If the product does not operate normally when the operating instructions are followed. Adjust only those controls that are covered by the operating instructions, since improper adjustment of other controls may result in damage and will often require extensive work by a qualified technician to restore the product to normal condition.
 - e. If the product has been dropped or the case has been damaged. If the product exhibits a distinct change in performance, indicating a need for service.
10. To avoid hazard of unexpected electrical shock, use the AC adapter only when the wall socket is properly grounded.