

myprojectorlamps.com

**The most trusted, dependable name
in projector lamp sales.**



<http://www.myprojectorlamps.com>



<http://www.myprojectorlamps.ca>



<http://www.myprojectorlamps.eu>

The following projector manual has not been modified or altered in any way.

Manual for

Acer Projector PD724/PD726 series

Disposal instructions

Do not throw this electronic device into the trash when discarding. To minimize pollution and ensure utmost protection of the global environment, please recycle it.



USA

For electronic products containing an LCD/CRT monitor or display, or a super high pressure mercury lamp:



Lamp(s) inside this product contain mercury and must be recycled or disposed of according to local, state or federal laws. For more information, contact the Electronic Industries Alliance at www.eiae.org. For lamp-specific disposal information, check www.lamprecycle.org.

Table of Contents

Table of Contents	1
Usage Notice.....	3
Precautions.....	3
Introduction.....	5
Product Features.....	5
Package Overview.....	6
Product Overview	7
Main Unit.....	7
Control Panel	8
Connection Ports	9
Remote Control with Laser Pointer.....	10
Installation	11
Connecting the Projector	11
Powering On/Off the Projector.....	13
Powering On the Projector.....	13
Powering Off the projector	14
Warning Indicator.....	14
Adjusting the Projected Image.....	15
Adjusting the Projector Image Height	15
Adjusting the Projector Zoom / Focus.....	16
Adjusting Projected Image Size.....	16
User Controls	17
Control Panel & Remote Control	17
On-Screen Display Menus.....	21
How to operate	21
Color (Computer/Video Mode)	22
Image (Computer/Video Mode).....	24
Management (Computer/Video Mode)	26
Audio (Computer/Video Mode)	32
Timer (Computer/Video Mode)	33
Language(Computer/Video Mode)	34
Wireless Projection.....	35
Introduction.....	35
System Requirements	35
I/O Interface	35
Setting up your WPG.....	36











Table of Contents

Connecting to the WPG for the first time	36
Downloading the software	37
Connecting to a projector	39
Using the audio function	40
Configuring your Acer WPG	42
Projector ID	42
Configuration password setup	42
Upgrade firmware	44
Network settings	44
Projection controls	45
Hide	45
Freeze	45
Projector remote control.....	45
Hotkey explanation	45
Appendices.....	46
Troubleshooting.....	46
Replacing the lamp.....	49
Specifications	51
Compatibility Modes	52
Regulation & safety notices	54

Usage Notice

Precautions

Follow all warnings, precautions and maintenance as recommended in this user's guide to maximize the life of your unit.

-  **Warning-** Do not look into the projector's lens when the lamp is on. The bright light may hurt your eyes.
-  **Warning-** To reduce the risk of fire or electric shock, do not expose this product to rain or moisture.
-  **Warning-** Please do not open or disassemble the product as this may cause electric shock.
-  **Warning-** When changing the lamp, please allow unit to cool down, and follow all changing instructions.
-  **Warning-** This product will detect the life of the lamp itself. Please be sure to change the lamp when it shows warning messages.
-  **Warning-** Reset the "Lamp Hour Reset" function from the On Screen Display "Management" menu after replacing the lamp module (refer to page 28)
-  **Warning-** When switching the projector off, please ensure the projector completes its cooling cycle before disconnecting power.
-  **Warning-** Turn on the projector first and then the signal sources.
-  **Warning-** Do not use lens cap when projector is in operation.
-  **Warning-** When the lamp reaches the end of its life, it will burn out and may make a loud popping sound. If this happens, the projector will not turn back on until the lamp module has been replaced. To replace the lamp, follow the procedures listed under "Replacing the Lamp".

Usage Notice

Do:

- ❖ Turn off the product before cleaning.
- ❖ Use a soft cloth moistened with mild detergent to clean the display housing.
- ❖ Disconnect the power plug from AC outlet if the product is not being used for a long period of time.

Don't:

- ❖ Block the slots and openings on the unit provided for ventilation.
- ❖ Use abrasive cleaners, waxes or solvents to clean the unit.
- ❖ Use under the following conditions:
 - In extremely hot, cold or humid environments.
 - In areas susceptible to excessive dust and dirt.
 - Near any appliance that generates a strong magnetic field.
 - Place in direct sunlight.

Introduction

Product Features

This product is an XGA single chip 0.7" DLP™ projector. Outstanding features include:

- ◆ True XGA, 1024 x 768 addressable pixels
- ◆ Single chip DLP™ technology
- ◆ NTSC3.58/NTSC4.43/PAL/SECAM and HDTV compatible (480i/p, 576i/p, 720p, 1080i)
- ◆ High-tech HDMI and DVI connection for digital signal with HDCP function and supports 480p, 576p, 720p and 1080i formats
- ◆ User friendly and powerful Acer Empowering key including: Acer eView Management, Acer eTimer Management and Acer eOpening Management.
- ◆ Full function remote control with laser pointer
- ◆ Advanced digital keystone correction and high quality full screen image re-scaling
- ◆ User friendly control panel
- ◆ SXGA, XGA compression and VGA, SVGA re-sizing
- ◆ Support HDMI input with HDMI 1.0 compliant
- ◆ Supports High bandwidth Digital Content Protection - HDCP 1.1 on HDMI input
- ◆ Mac compatible

Introduction

Package Overview

This projector comes with all the items shown below. Check to make sure your unit is complete. Contact your dealer immediately if anything is missing.



Projector



Power Cord 1.8m



VGA Cable 1.8m



Composite Video Cable
2.0m



USB Cable 1.8m



S-Video Cable 1.8m



Audio Cable Jack /Jack
1.8m



3 RCA Component Cable
1.8m



Remote Control with
Laser Pointer



Detachable cable holder



2 x Battery



Carrying Case



Quick Start Card



User's Guide

Introduction

Product Overview

Main Unit



❖ Two remote control receiver provided at front panel and front-top cover.

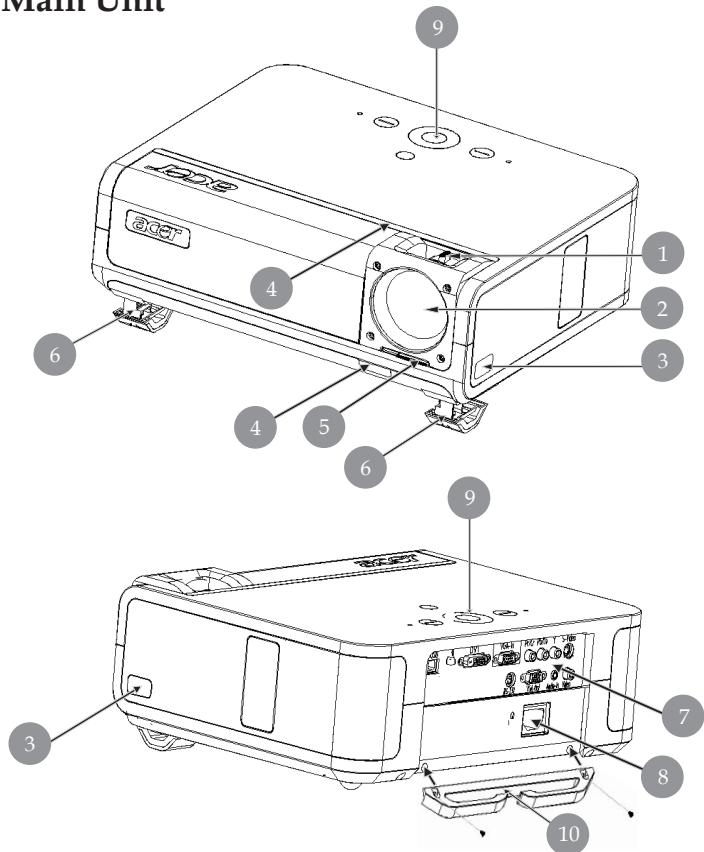

1. Focus Ring/Zoom Ring
2. Zoom Lens
3. Elevator Button
4. Remote Control Receiver
5. Lens Cap Switch
6. Elevator Foot
7. Connection Ports
8. Power Socket
9. Control Panel
10. Detachable cable holder

Introduction

Control Panel

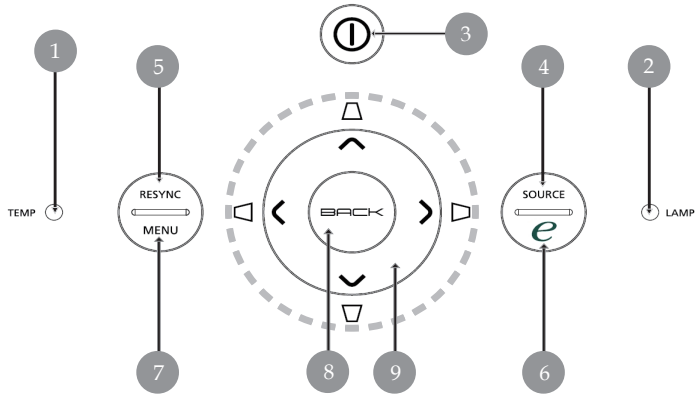

1. Temp Indicator LED
2. Lamp Indicator LED
3. Power and Indicator LED (Power LED)
4. Source
5. Resync
6. Empowering Key
7. Menu
8. Back
9. Four Directional Select Keys (Keystone)

Introduction

Connection Ports

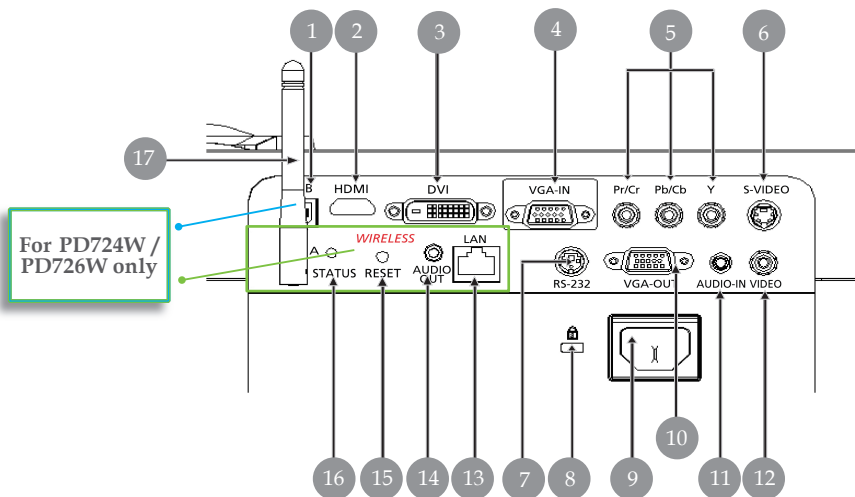

1. USB Connector
2. HDMI Connector
3. DVI Input Connector
4. VGA Input Connector (PC Analog Signal)
5. Component Video Input Connector
6. S-Video Input Connector
7. RS232 Connector
8. Kensington™ Lock Port
9. Power Socket
10. VGA Output Connector (Monitor Loop-through Output Connector)
11. Audio Input Connector
12. Composite Video Input Connector
- Below items are for PD724W/PD726W only:*
13. Lan (RJ45 Port for 10/100M Ethernet)
14. Audio Output Connector
15. Reset Button
16. Status Indicator
17. Antenna

Introduction

Remote Control with Laser Pointer

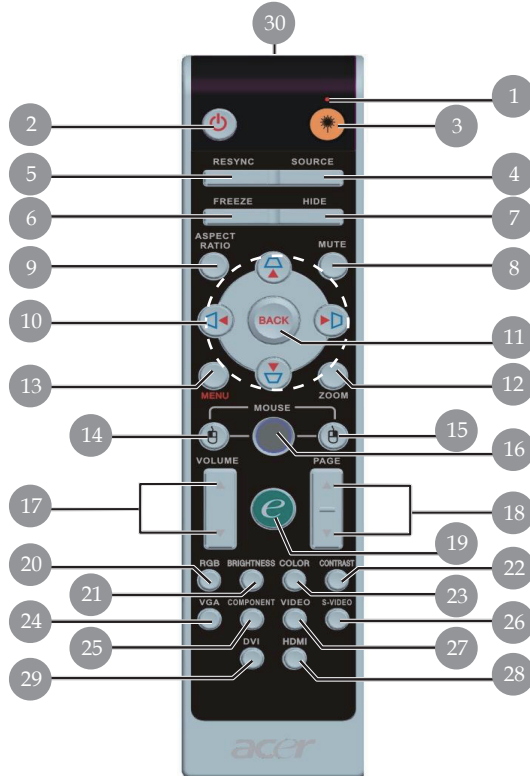

- | | |
|--|------------------------------|
| 1. Laser Pointer | 16. Mouse |
| 2. Power | 17. Volume +/- |
| 3. Laser Button | 18. Page Up/Page Down |
| 4. Source | 19. Empowering Key |
| 5. Resync | 20. RGB |
| 6. Freeze | 21. Brightness |
| 7. Hide | 22. Contrast |
| 8. Mute | 23. Color |
| 9. Aspect Ratio | 24. VGA |
| 10. Keystone/Four Directional
Select Keys | 25. Component |
| 11. Back | 26. S-Video |
| 12. Digital Zoom | 27. Video |
| 13. Menu | 28. HDMI |
| 14. Mouse Left Click | 29. DVI |
| 15. Mouse Right Click | 30. Transmit Indicator Light |

Installation

Connecting the Projector

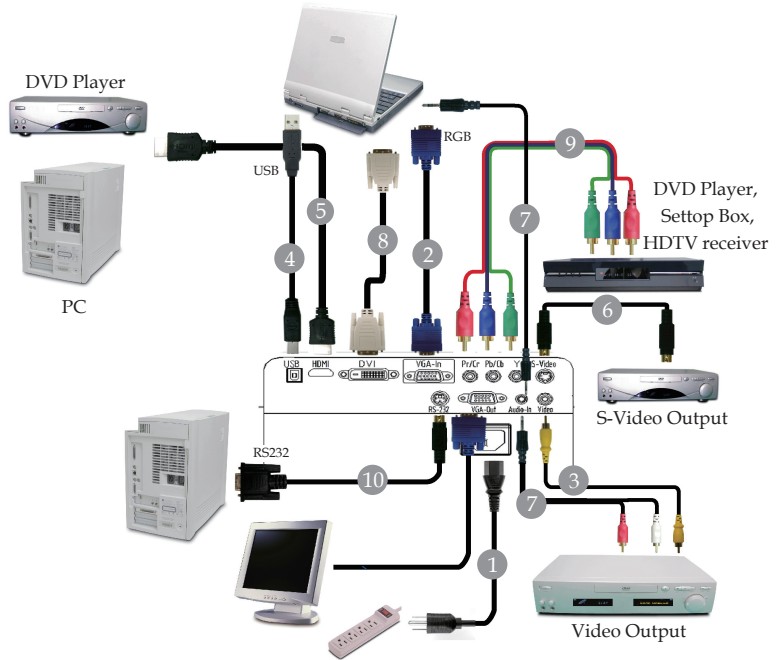

-
- 1..... Power Cord
 - 2..... VGA Cable
 - 3..... Composite Video Cable
 - 4..... USB Cable
 - 5..... HDMI Cable(Optional Accessory)
 - 6..... S-Video Cable
 - 7..... Audio Cable Jack/Jack or Audio Cable Jack/RCA
 - 8..... DVI Cable (Optional Accessory)
 - 9..... 3 RCA Component Cable
 - 10..... RS232 Cable (Optional Accessory)
-

❖ *To ensure the projector works well with your computer, please make sure the timing of the display mode is compatible with the projector. Refer to the "Compatibility Modes" section on page 53.*

Installation

Connecting the Projector

For Wireless function

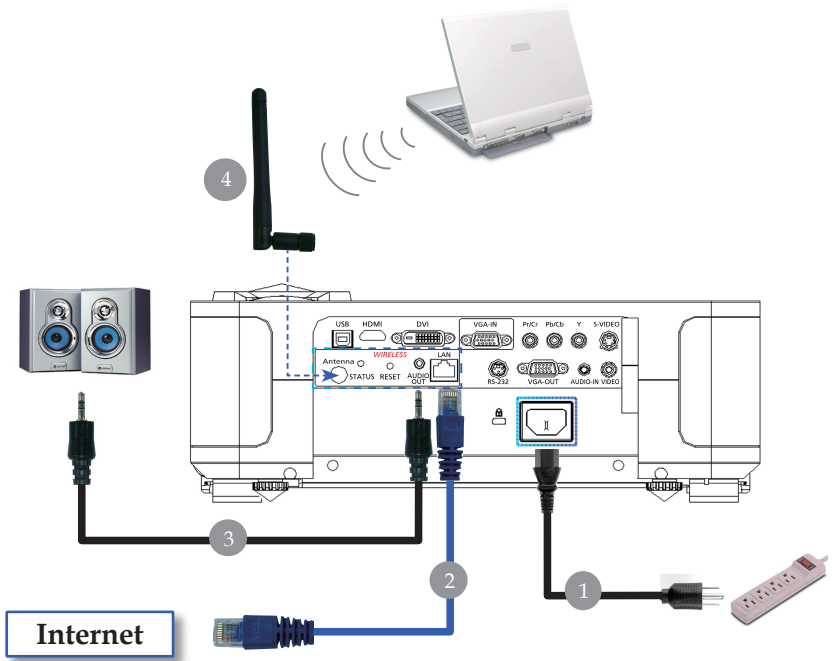

-
- 1.....Power Cord
 - 2.....Lan Cable
 - 3.....Audio Cable Jack/ Jack
 - 4.....Antenna
- (for PD724W/PD726W only, need to attach the antenna by user)*
-

Installation

Powering On/Off the Projector

Powering On the Projector



❖ The lens cap must be open then turn on the projector.

❖ Turn on the projector first and then the signal sources.

1. Open the lens cap.
 2. Ensure that the power cord and signal cable are securely connected. The Power LED will flash **amber**.
 3. Turn on the lamp by pressing "Power" button on the control panel. **1** And the Power LED will turn **amber**.
 4. Turn on your source (computer, notebook, video player, etc.). The projector will detect your source automatically.
- ❖ *If the screen displays "Lock" & "Source" icons, it means the projector locks on this source type and there is no such type of input signal found.*
 - ❖ *If the screen displays "No Signal", please make sure the signal cables are securely connected.*
 - ❖ *If you connect multiple sources at the same time, using the "Source" button on the remote control or control panel to switch.*

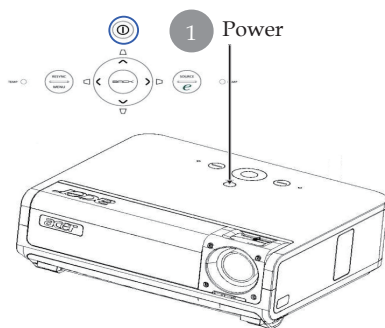

- ❑ If the projection lens cap is not opened when a projector is powered on, users will hear a continuous two-beep sound, and the interval of each two-beep warning message is about 3 seconds.
- ❑ The projector will not be turned on and automatically gone to a stand-by mode if the lens cap is still closed after two-beep sound warning for 5 times.
- ❑ If the projection lens cap is accidentally closed while the projector is running, users will hear the same beep and the projector will automatically go to a stand-by mode if the lens cap is still not opened after 5 times of warning message.

Installation

Powering Off the Projector

1. Press the "Power" button to turn off the projector lamp, you will see a message "Please press power button again to complete the shutdown process. Warning: DO NOT unplug while the projector fan is still running." displayed on the projector's screen. Press the "Power" button again to confirm, otherwise the message will disappear after 5 seconds.
2. The cooling fans continue to operate for about 30 seconds for cooling cycle and the Power LED will be quick **amber flash**. When the Power LED becomes slow flashing, the projector has entered standby mode. If you wish to turn the projector back on, you must wait until the projector has completed the cooling cycle and has entered standby mode. Once in standby mode, simply press "Power" button to restart the projector.
3. Disconnect the power cord from the electrical outlet and the projector.
4. Do not turn on the projector immediately following a power off procedure.
5. Close the lens cap to prevent dust if you like.

Warning Indicator

- ❖ *When the "LAMP" indicator lights solid amber, the projector will automatically shut itself down. Please contact your local reseller or service center.*
- ❖ *When the "TEMP" indicator lights solid amber for about **20** seconds, it indicates the projector has been overheated. You will see a message "Projector Overheated. Lamp will automatically turn off soon." on the on-screen display. The projector will automatically shut itself down.*

Under normal conditions, the projector can be switched on again after it has cooled down. If the problem persists, you should contact your local dealer or our service center.

- ❖ *When the "TEMP" indicator flashes amber for about **30** seconds, you will see a message "Fan fail. Lamp will automatically turn off soon." on the on-screen display. Please contact your local dealer or our service center.*

Installation

Adjusting the Projected Image

Adjusting the Projector Image Height

The projector is equipped with elevator feet for adjusting the image height.

To raise the image:

1. Press the elevator button **1**.
2. Raise the image to the desired height angle **2** , then release the button to lock the elevator feet into position.
3. Use **3** to fine-tune the display angle.

To lower the image:

1. Press the elevator button.
2. Lower the image, then release the button to lock the elevator feet into position.
3. Use **3** to fine-tune the display angle.

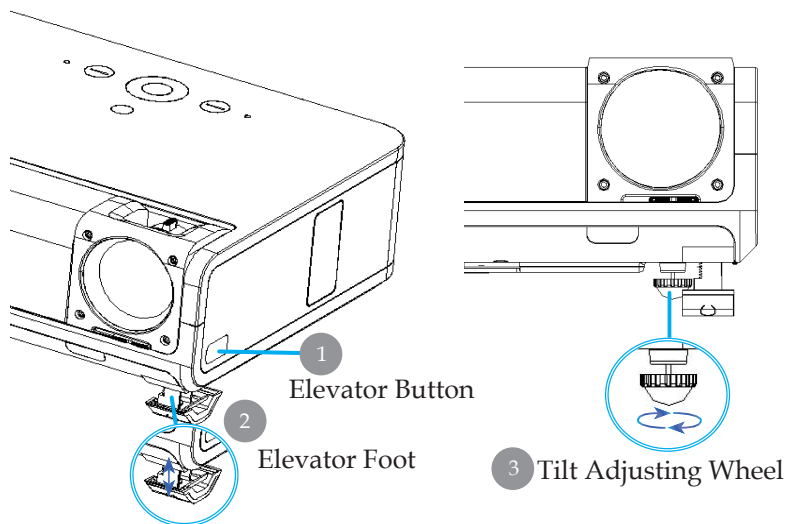

Installation

Adjusting the Projector Zoom / Focus

You may turn the zoom ring to zoom in or out. To focus the image, rotate the focus ring until the image is clear. The projector will focus at distances from 3.94 to 39.43 feet (1.2 to 12.02 meters).

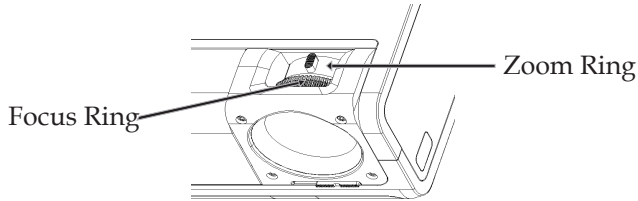

Adjusting Projection Image Size

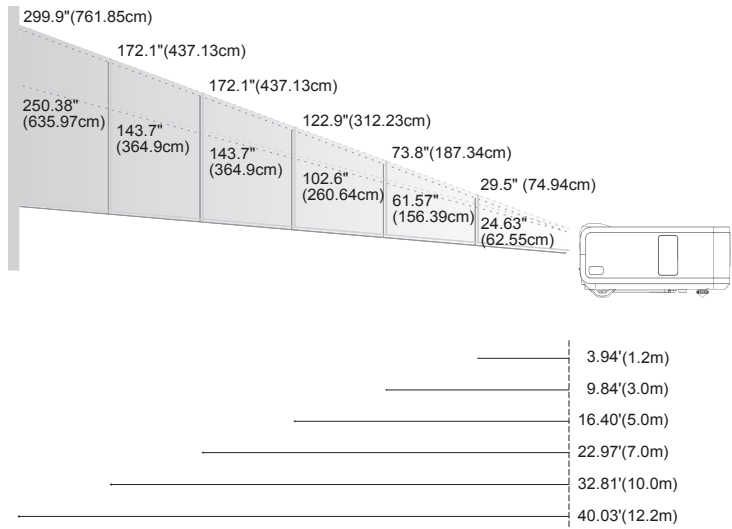

Screen (Diagonal)	Max.	29.50" (74.9cm)	73.76" (187.3cm)	122.93" (312.2cm)	172.10" (437.1cm)	245.85" (624.5cm)	299.94" (761.9cm)
	Min.	24.63" (62.6cm)	61.57" (156.4cm)	102.62" (260.6cm)	143.66" (364.9cm)	205.23" (521.3cm)	250.38" (636.0cm)
Screen Size	Max.(WxH)	23.60" x 17.70" (60.0 x 45.0cm)	59.00" x 44.25" (149.9 x 112.4cm)	98.34" x 73.76" (249.8 x 187.3cm)	137.68" x 103.26" (349.7 x 262.3cm)	196.68" x 147.51" (499.6 x 374.7cm)	239.95" x 179.96" (609.5 x 457.1cm)
	Min.(WxH)	19.70" x 14.78" (50.0 x 37.5cm)	49.26" x 36.94" (125.1 x 93.8cm)	73.76" x 52.09" (187.30 x 132.8cm)	103.26" x 73.76" (262.3 x 187.3cm)	164.18" x 123.14" (417.0 x 312.8cm)	200.31" x 150.23" (508.8 x 381.6cm)
Distance		3.94'(1.2m)	9.84'(3.0m)	16.40'(5.0m)	22.97'(7.0m)	32.81'(10.0m)	40.03'(12.2m)

❖ This graph is for user's reference only.

User Controls

Control Panel & Remote Control

There are two ways for you to control the functions: Remote Control and Control Panel.

Control Panel

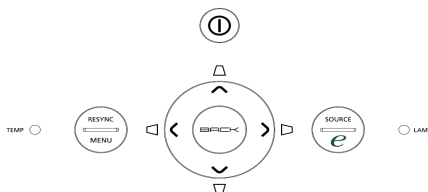

Using the Control Panel

Power

- ▶ Refer to the "Power On/Off the Projector" section on pages 13-14.

Resync

- ▶ Automatically synchronizes the projector to the input source.

Menu

- ▶ Press "Menu" to launch the on screen display (OSD) menu. To exit OSD, press "Menu" again.
- ▶ Confirm your selection of items.

Source

- ▶ Press "Source" to choose RGB, Component-p, Component-i, S-Video, Composite, DVI-D/A, Video, HDTV and HDMI sources.

Four Directional Select Keys

- ▶ Use to select items or make adjustments to your selection.

Keystone

- ▶ Adjusts image distortion caused by tilting the projector (± 16 degrees).

Empowering Key

Acer Empowering Key provides three Acer unique functions, they are "Acer eView Management", "Acer eTimer Management" and "Acer eOpening Management" respectively. Press "e" key for more than one second to launch the on screen display main menu to modify its function.

Back

- ▶ Back to the previous step for the OSD menu operation.

User Controls

Using the Remote Control

Remote Control



Power

- ▶ Refer to the “Power On/Off the Projector” section on pages 13-14

Laser Button

- ▶ Aim the remote at the viewing screen, press and hold this button to activate the laser pointer.

Resync

- ▶ Automatically synchronizes the projector to the input source.

Source

- ▶ Press “Source” to choose RGB, Component-p, Component-i, S-Video, Composite Video, DVI-D/A, HDTV and HDMI sources.

Freeze

- ▶ Press “Freeze” to pause the screen image.

Hide

- ▶ Momentarily turns off the video. Press “Hide” to hide image, press again to restore display of the image.





Aspect Ratio

- ▶ Use this function to choose your desired aspect ratio. (Auto/4:3/16:9/1:1)

Mute

- ▶ Use this key to close the volume.

Four Directional Select Keys

- ▶ Use     to select items or make adjustments to your selection for the OSD menu operation.

Keystone

- ▶ Adjusts image distortion caused by tilting the projector (± 16 degrees).

Menu

- ▶ Press “Menu” to launch the on screen display menu. To exit OSD, press “Menu” again.

Zoom

- ▶ Digital Zoom in/out.

Back

- ▶ Back to the previous step for the OSD menu operation.

Mouse / Mouse Right Click / Mouse Left Click

- ▶ These functions are the same as a mouse of PC or Mac. These functions are available only when the projector is connected to a computer via an USB cable.

User Controls



Empowering Key

Acer Empowering Key provides three Acer unique functions, they are "Acer eView Management", "Acer eTimer Management" and "Acer eOpening Management" respectively. Press "e" key for more than one second to launch the on screen display main menu to modify its function.

Acer eView Management

- ▶ Press "e" to launch "Acer eView Management" sub-menu.

"Acer eView Management" is for display mode selection. Please refer to On Screen Display Menus section for more detail.

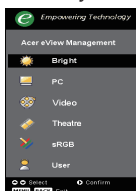

Acer eTimer Management

- ▶ Press "e" to launch "Acer eTimer Management" sub-menu.

"Acer eTimer Management" provides the reminding function for presentation time control. Please refer to On Screen Display Menus section for more detail.

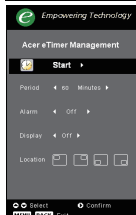

Acer eOpening Management

- ▶ Press "e" to launch "Acer eOpening Management" sub-menu.

"Acer eOpening Management" allows user to change the Startup screen to their personalized image. Please refer to On Screen Display section for details.

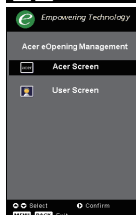

Volume

- ▶ Increase/decrease the volume.

Page Up (Computer mode only)

- ▶ Use this button to page up. This function is only available when the projector is connected to a computer via an USB cable.

Page Down (Computer mode only)

- ▶ Use this button to page down. This function is only available when the projector is connected to a computer via an USB cable.

RGB

- ▶ Press "RGB" for true-color optimization.

Brightness

- ▶ Press "Brightness" to adjust the brightness of the image.

User Controls

Color

- ▶ Press “Color” to adjust the color temperature of image.

Contrast

- ▶ Press “Contrast” to control the difference between the lightest and darkest parts of the picture.

VGA

- ▶ Press “VGA” to change source to VGA-In connector. This connector supports Analog RGB, YPbPr (480p/576p/720p/1080i), YCbCr (480i/576i) and RGBsync.

Component

- ▶ Press “Component” to change source to component connector. This connector supports YPbPr (480p/576p/720p/1080i) and YCbCr (480i/576i)

Video

- ▶ Press “Video” to change source to Composite Video source.

S-Video

- ▶ Press “S-Video” to change source to S-Video source.

DVI

- ▶ Press “DVI” to change source to DVI connector. This connector supports Digital RGB, Analog RGB, YPbPr (480p/576p/720p/1080i), YCbCr (480i/576i) and HDCP signal.

HDMI

- ▶ Press “HDMI” to change source to HDMI. This connector can support to carry all standard and high-definition consumer electronics video formats.

On Screen Display Menus

The Projector has multilingual On Screen Display menus that allow you to make image adjustments and change a variety of settings. The projector will automatically detect the source.

How to operate

1. To open the OSD menu, press "Menu" on the Remote Control or Control Panel.
2. When OSD is displayed, use ▲ ▼ keys to select any item in the main menu. After selecting the desired main menu item, press ► to enter sub menu for feature setting.
3. Use ▲ ▼ keys to select the desired item and adjust the settings by ◀ ▶ key.
4. Select the next item to be adjusted in the sub menu and adjust as described above.
5. Press "Back" on the Remote Control or Control Panel, the screen will return to the main menu.
6. To exit OSD, press "Menu" on the Remote Control or Control Panel again. The OSD menu will close and the projector will automatically save the new settings.

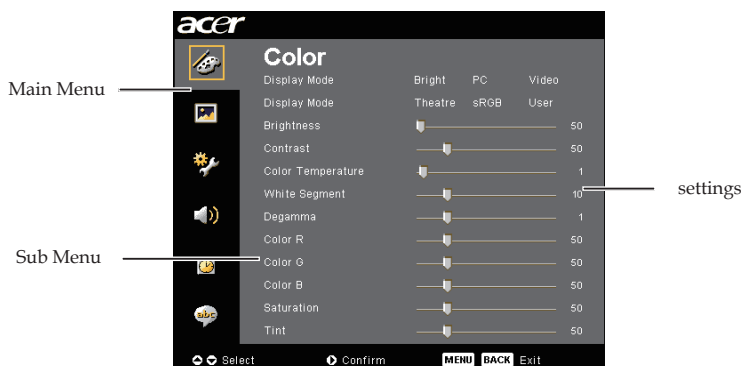

User Controls

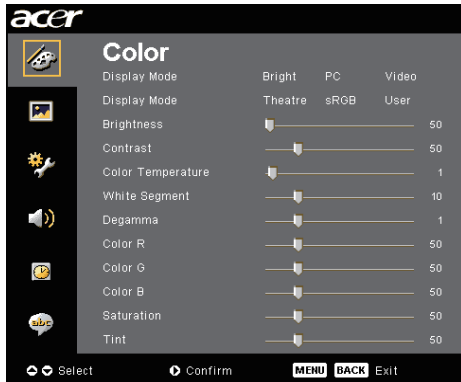

Color (Computer / Video Mode)

Display Mode

There are many factory presets optimized for various types of images.

- ▶ Bright : For brightness optimization.
- ▶ PC : For computer or notebook.
- ▶ Video : For playing video in a bright environment.
- ▶ Theater : For Home Theatre usage in a dark room.
- ▶ sRGB : For true-color optimization.
- ▶ User : Memorize user's settings.

Brightness

Adjust the brightness of the image.

- ▶ Press the ◀ to darken image.
- ▶ Press the ▶ to lighten the image.

Contrast

The contrast controls the degree of difference between the lightest and darkest parts of the picture. Adjusting the contrast changes the amount of black and white in the image.

- ▶ Press the ◀ to decrease the contrast.
- ▶ Press the ▶ to increase the contrast.

Color Temperature

Adjust the color temperature. At higher temperature, the screen looks colder; at lower temperature, the screen looks warmer.

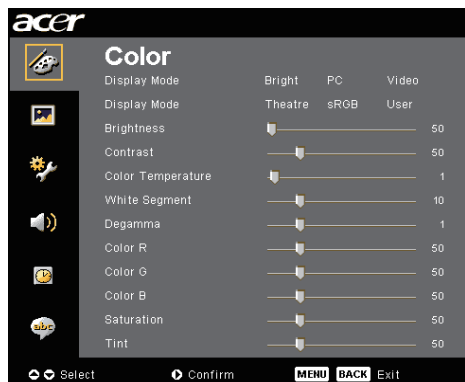

Color (Computer / Video Mode)

White Segment

Use the white Segment control to set the white peaking level of DMD chip. 0 stands for minimal segment, and 10 stands for maximum segment. If you prefer a stronger image, adjust towards the maximum setting. For a smooth and more natural image, adjust towards the minimum setting.

Degamma

Effects the represent of dark scenery. With greater gamma value, dark scenery will look brighter.

Color R

Adjusts the red color.

Color G

Adjusts the green color.

Color B

Adjusts the blue color.

Saturation

Adjusts a video image from black and white to fully saturated color.

- ▶ Press the ◀ to decrease the amount of color in the image.
- ▶ Press the ▶ to increase the amount of color in the image.

Tint

Adjusts the color balance of red and green.

- ▶ Press the ◀ to increase the amount of green in the image.
- ▶ Press the ▶ to increase the amount of red in the image.



❖ “Saturation” and “Tint” functions are not supported under computer mode or DVI mode.

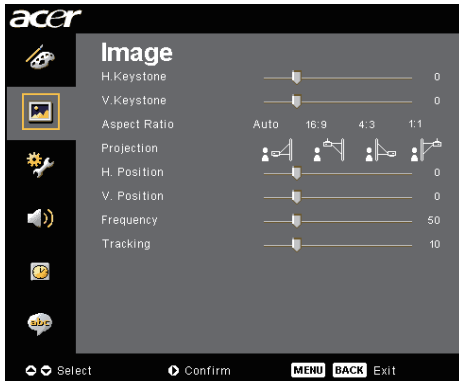

Image (Computer / Video Mode)

H. Keystone (Horizontal Keystone)

- ▶ Press the ◀ or ▶ button to adjust image distortion horizontally and makes a squarer image.

V. Keystone (Vertical Keystone)



- ▶ Press the ◀ or ▶ button to adjust image distortion vertically and makes a squarer image.

Aspect Ratio

Use this function to choose your desired aspect ratio.

- ▶ Auto :Keep the image with original width-highth ratio and maximize the image to fit native horizontal or vertical pixels.
- ▶ 16:9 : The input source will be scaled to fit the width of the screen and narrowed the height to make the displayed image becomes 16:9 ratio.
- ▶ 4:3 : The input source will be scaled to fit the projection screen and becomes 4:3 ratio.
- ▶ 1:1 : Keep image at the center of screen with its original pixel resolution without scaling.

Projection

- ▶  **Front-Desktop**
The factory default setting.
- ▶  **Front-Ceiling**
When you select this function, the projector turns the image upside down for ceiling-mounted projection.
- ▶  **Rear-Desktop**
When you select this function, the projector reverses the image so you can project behind a translucent screen.

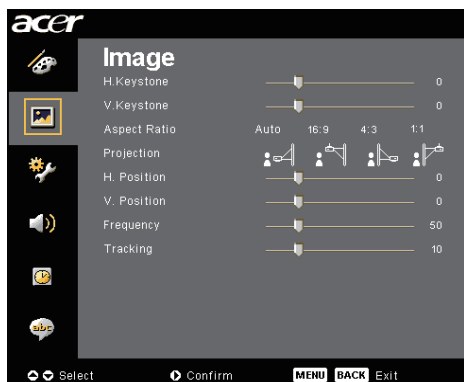

Image (Computer/Video Mode)



Rear-Ceiling

When you select this function, the projector reverses and turns the image upside down at same time. You can project from behind a translucent screen with ceiling mounted projection.



❖ “H. Position”, “V. Position”, “Frequency” and “Tracking” functions are not supported under DVI and Video mode.

H. Position (Horizontal Position)

- ▶ Press the ◀ to move the image left.
- ▶ Press the ▶ to move the image right.

V. Position (Vertical Position)

- ▶ Press the ◀ to move the image down.
- ▶ Press the ▶ to move the image up.

Frequency

“Frequency” changes the display data frequency to match the frequency of your computer’s graphic card. If you experience a vertical flickering bar, use this function to make an adjustment.

Tracking

“Tracking” synchronizes the signal timing of the display with the graphic card. If you experience an unstable or flickering image, use this function to correct it.



❖ “Sharpness” functions is not supported under DVI and Computer mode.

Sharpness

Adjusts the sharpness of the image.

- ▶ Press the ◀ to decrease the sharpness.
- ▶ Press the ▶ to increase the sharpness.

Signal Type

Press the ▶ or ◀ button to change source to RGB, YPbPr or YCbCr.

❖ “Signal Type” is only available for Component, HDMI and SCART signal sources.



Management (Computer / Video Mode)

ECO Mode

Choose "On" to dim the projector lamp which will lower power consumption, extend the lamp life and reduce noise. Choose "Off" to return normal mode.

Auto Shutdown(Minutes)

The projector will auto shutdown while there is no signal input after the setting time.

Source Lock

When source lock is turned off, the projector will search for other signals if the current input signal is lost. When source lock is turned on, it will "Lock" the current source channel before you press "Source" button on remote control for next channel.

Menu Location

Choose the Menu location on the display screen.

Startup Screen

Use this function to select your desired startup screen. If you change the setting from one to another, when you exit the OSD menu, the new setting will take effect.

- ▶ Acer : The default startup screen of Acer projector.
- ▶ User : The user customized startup screen, which is down loaded from PC to projector via the USB cable and *Acer eOpening Management* utility (refer to the description of below section).

User Controls



Management (Computer / Video Mode)

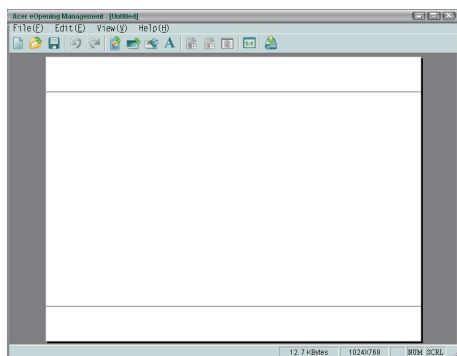

Acer eOpening Management is a PC utility for user to change the default startup screen of Acer projector to their desired image. You can install *Acer eOpening Management* from the bundled CD. Connect the projector to your PC with the bundled USB cable then execute *Acer eOpening Management* utility to download your desired image from your PC to projector. Before the download starts, the projector must enter "Download Mode" first. Please follow the instruction below to enter "Download Mode".

1. If the AC power cord of the projector was unplugged, plug the AC power.
2. Powering On the Projector
3. Please make sure the USB cable has been plugged and connected to your projector.

Lamp Hour Elapse

Displays the lamp's elapsed operating time (in hours).



Lamp Reminding

Choose this function to show or to hide warning message when the changing lamp message is displayed. The message will show up 30 hours before end of life.



Management (Computer / Video Mode)

Lamp Hour Reset

Press the button after choosing "Yes" to turn the lamp hour counter to 0 hours.

Security

Press to start "Security" setting. If the "Security" function is enabled, your must enter "Administrator Password" first before Security setting.

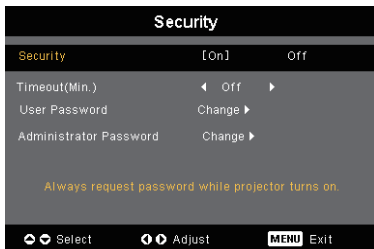

Security

This projector provides an excellent security function for the administrator to manage the usage of the projector .

- ▶ Select "On" to enable the security function. User have to enter password depending on the " Security Mode" . Please refer to "User Password" section for details.
- ▶ Select "Off" then user can switch on the projector without password request.

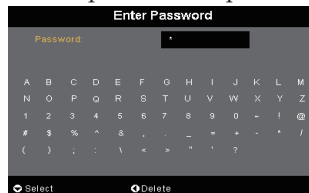

Once the security function is enabled, the projector will request user to enter password when switch on the projector. Both "User Password" and "Administrator Password" can be accepted for this dialogue.

User Controls



Management (Computer / Video Mode)

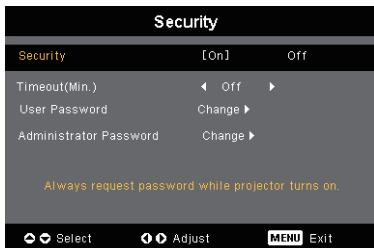

Timeout(Min.)

Once “Security” is set to “On”, administrator can set timeout function.

- ▶ Press ◀ or ▶ to select timeout duration.
- ▶ The range is from 10 minutes to 990 minutes.
- ▶ When time is up, the projector will request user to enter password again.
- ▶ The factory default setting of “Timeout(Min.)” is “Off”.

User Password

- ▶ Press ▶ to set up or change “User Password”.



- ▶ Use ▲, ▼, ◀ or ▶ to select the character and press “MENU” to confirm.
- ▶ Press ◀ to delete character after the selected character confirmed.
- ▶ Press “MENU” to complete the setting of password.
- ▶ Input password again at “Confirm Password”.
- ▶ The password is allowed for 4~8 characters.

User Controls



Management (Computer / Video Mode)



The projector provide two options of "Security Mode".

- ▶ Select "Request password only after plugging power cord", the project will request user to input password only for the first time plugging on power cord of the projector.
- ▶ Select "Always request password while projector turns on", user have to input password every time when switching on the projector.

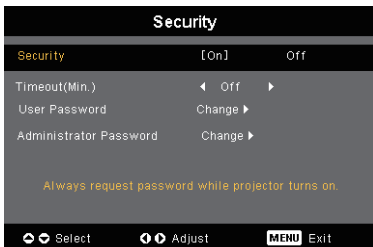

Administrator Password

"Administrator Password" can be accepted by both "Enter Administrator Password" and "Enter Password" dialogues.

- ▶ Press **Enter** to change "Administrator Password".



- ▶ The factory default of "Administrator Password" is "1234".

User Controls



Management (Computer / Video Mode)

If administrator forgot “Administrator Password”, do the following to retrieve the “Administrator Password”:



1. Press “MENU” for more than 4 seconds when any of “Enter Password” or “Enter Administrator Password” dialogue is currently displayed.

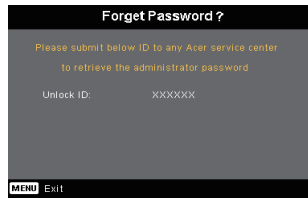

2. Write down the “Unlock ID” and contact with Acer service center. They will give you new Administrator Password according to the Unlock ID.
3. Once the new “Administrator Password” retrieved from Acer has been logged into the projector, old “Administrator Password” will be replaced by the new password.



Reset

Press the  button after choosing “Yes” to return the display parameters on all menus to the factory default settings.



Audio (Computer / Video Mode)

Volume

- ▶ Press the ◀ to decrease the volume.
- ▶ Press the ▶ to increase the volume.

Mute

- ▶ Choose the “On” to turn mute on.
- ▶ Choose the “Off” to turn mute off.

Power On/Off Volume

- ▶ Choose this function to adjust volume when power on/off.

Alarm Volume

- ▶ Choose this function to adjust volume when there are errors of the projector.

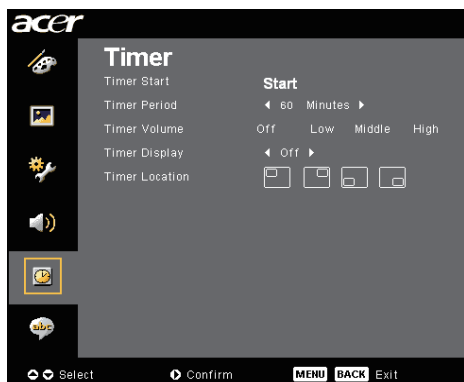

Timer (Computer / Video Mode)

Timer Start

- ▶ Press the  to start/stop timer.

Timer Period

- ▶ Press the  to adjust timer period.

Timer Volume

- ▶ Choose this function to adjust volume when timer function is enable and time is up.

Timer Display

- ▶ Press the  to choose timer display mode on the screen.

Timer Location



- ▶ Choose the timer location on the screen.

User Controls



Language (Computer / Video Mode)

Language

Choose the multilingual OSD menu . Use the  or  key to select your preferred language.

- ▶ Press  to confirm the selection

Wireless projection

Introduction

This section will introduce wireless projection function for this projector. The wireless projection function is only available for the model which is equipped with integrated Acer Wireless Presentation Gateway (WPG) module. Acer WPG enables multiple users to connect to an Acer projector wirelessly. This eliminates the need to plug and unplug cables, enabling more efficient use of meeting time, especially when there is more than one presenter in a meeting.

To perform wireless projection, you have to change the input source type to "Wireless" by pressing the "Wireless" button on the remote control or the "Source" button on the control panel or remote control.

System Requirements:

- Operating system: Windows® 2000 or Windows® XP
- CPU: Intel® Pentium® III at 750 MHz or equivalent with 128 MB of RAM
- Wireless LAN: IEEE 802.11b/g enabled
- Internet Browser: Internet Explorer 5.0 or above

I/O Interface:

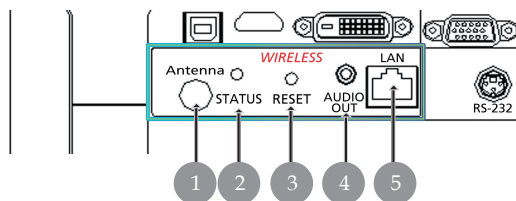

No.	Item	Description
1	Antenna connector	For attaching the external antenna.
2	Status LED	Indicates the WPG's status.
3	Reset button	A quick press on the the Reset button will reset the WPG without changing any user's settings. Press and hold Reset button for more than 4 seconds to reset the WPG to its factory default settings.
4	Audio-out jack	For outputting audio signals received wirelessly from the PC.
5	RJ-45 Ethernet jack	For connecting the WPG to the Internet via a LAN.

Wireless projection

Setting up your WPG

Check the LED for the power status.

- Red indicates that the WPG is receiving power, but is inactive.
- Green indicates that the WPG is being used to project images.

You may also like to connect a LAN cable to the LAN (RJ-45) port on the side of the dongle. This will allow you to connect to the Internet to retrieve interactive content or download firmware upgrades as they become available.

Connecting to the WPG for the first time

If this is the first time you've connected to the WPG, you will need to download and install the driver from the WPG. The software is stored on the WPG, so there is no need for an installation CD. Ensure that you have administrator-level permission on your computer so that you can install the software.

-  **To download the software, you must ensure that your browser is set to open up a website. If your browser is set to open with a blank page, you will not be able to download the software. To check this, select Tools > Internet Options. Ensure that there is a website in the text box.**

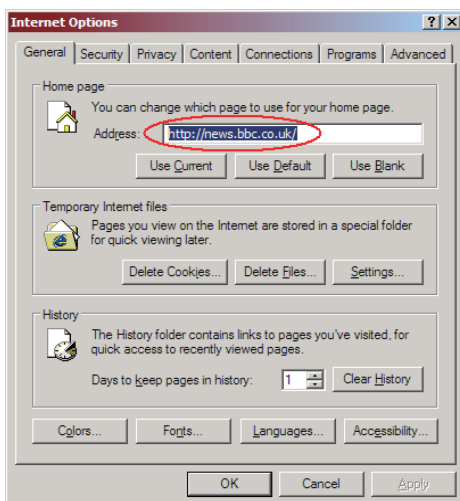

Wireless projection

Downloading the software

- 1) Switch on your notebook, and activate the wireless LAN.
- 2) Scan for available WLAN APs using your preferred WLAN manager.
- 3) Select the AP labeled "AcerProjector" from the list of available APs. Connect to this AP. If there is more than one WPG listed, determine which one is the one you want to connect to from the SSID listed in the upper left-hand corner of the screen.

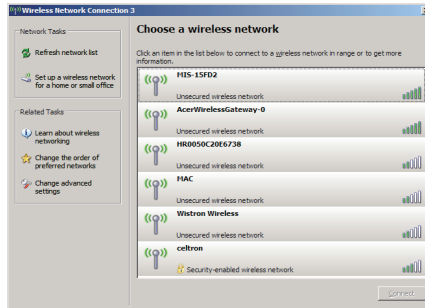

- 4) If you receive any security warnings, select "Connect Anyway."

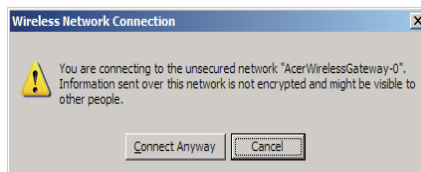

- 5) Once the connection is established, open your Internet browser. You will automatically be taken to the Acer WPG welcome page, where you will be able to download the driver.



Wireless projection

- 6) Click on the link to download and install the driver. If you receive any security warnings, click "OK" to proceed with the installation procedure. During the driver installation, your screen may flicker.

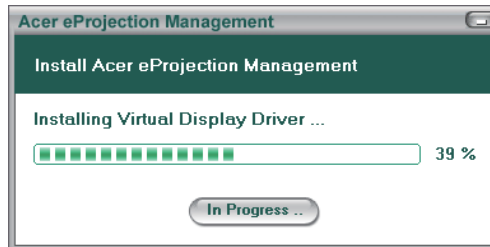

- 7) Once the installation is complete, the Acer Wireless Projection Gateway software will open.

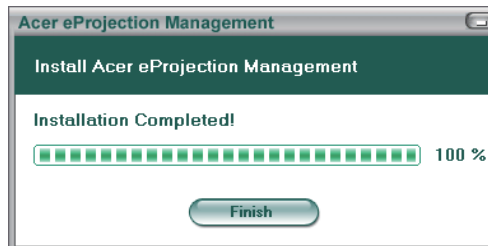

Wireless projection

Connecting to a projector

Once you've installed the software, you will be able to connect to any projector that is equipped with the Acer WPG. To connect to a projector, simply double-click the Acer WPG icon on your desktop to launch the application.



The application will automatically detect available WPGs. Each WPG is identifiable by the "AcerProjector" indicator in the SSID. If the projector is installed in a permanent location, you may also choose to assign a specific SSID to that projector, indicating, for example, the number of the room in which the projector is installed (refer to "Configuration" later in this guide).

If there are multiple WPGs within the range of your notebook's receiver (they may be in different rooms), and the feature is enabled (refer to "Configuration" later in this guide), you will be able to identify the correct one by the "Projector ID" indicated in the top left-hand corner of the projected screen. The Projector ID consists of four randomly-generated numbers. Entering these numbers into the WPG application on your notebook will restrict your connection to only that projector.

Only one user can use the WPG at any time; if another user wishes to use the projector, you will need to click Disconnect to stop using the projector, and allow someone else to use the projector.

Wireless projection

Using the audio function

If “Wireless” is selected as the input source, you can play audio content through the internal speakers of the projector. You can also plug external speakers into the WPG’s audio-out jack for better audio quality.



Your audio driver may have different terminology for some of the settings required below.

If you wish to use the WPG’s audio features, please ensure that none of the audio settings is muted.

To set up the audio, you must perform the following steps:

- 1) Open the Windows® audio controls by double-clicking on the speaker icon in the task tray.
- 2) Select Options > Properties.

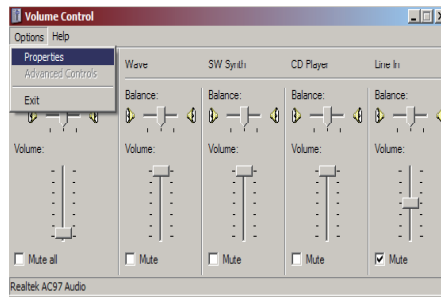

- 3) Select Recording in the “Adjust volume for” area.

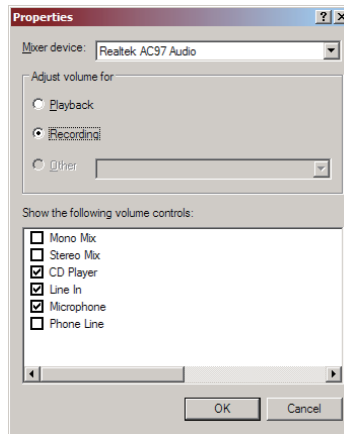

Wireless projection

- 4) Ensure that Mono Mix, Stereo Mix and/or Wave-out Mix are checked.

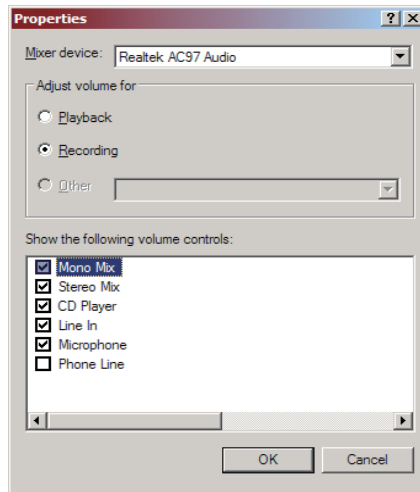

- 5) Click OK to open the “Recording Mix” window. Ensure that Mono Mix, Stereo Mix or Wave-out Mix is selected.

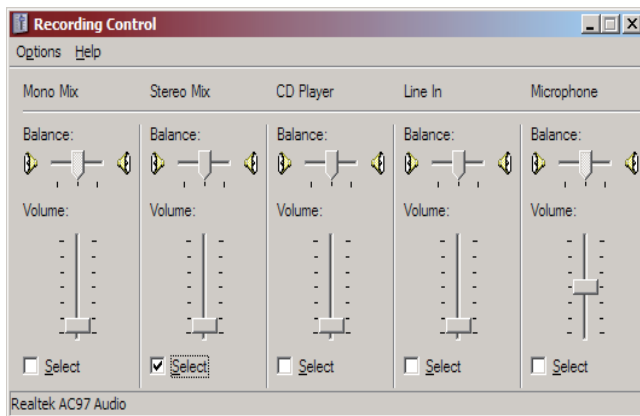

Wireless projection

Configuring your Acer WPG

You will need to be connected to an Acer WPG to change any configuration settings. Once you're connected, click the Configure button in the upper right-hand corner of the Acer WPG screen.

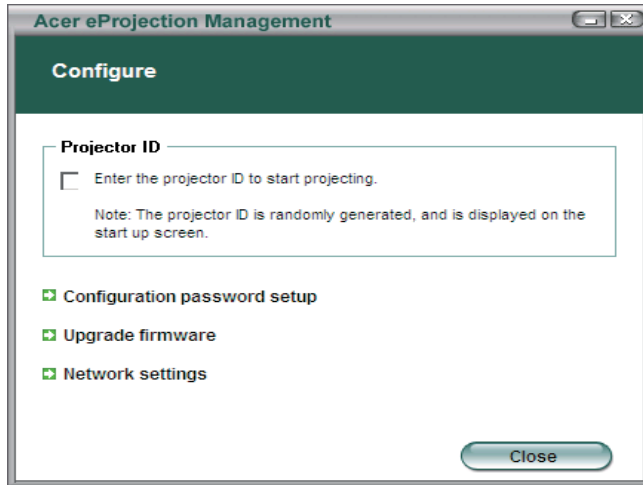

Projector ID

Check this feature to enable projector identification. If this option is enabled, a 4-digit number will be displayed when the projector is started up, or when the projector is not receiving any input.

Configuration password setup

Use this to set a password to restrict access to the configuration menus. This is useful when the WPG is used by a number of people, and you do not wish unauthorized persons to make any changes to the configuration.

The first time you click on this link, you will see the following:

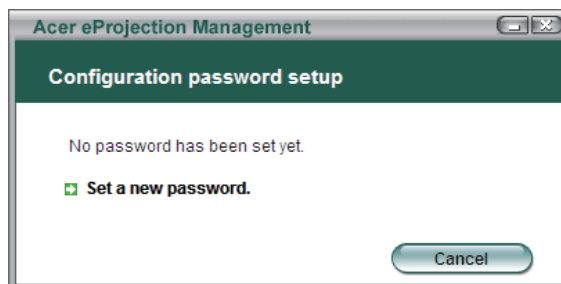

Wireless projection

Click on Set a new password to set a password.

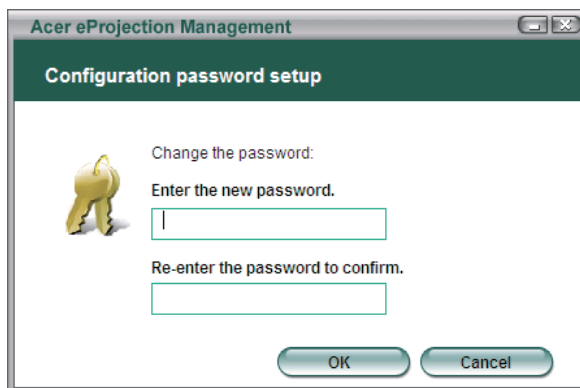

Enter the password – it can be up to 16 characters in length.

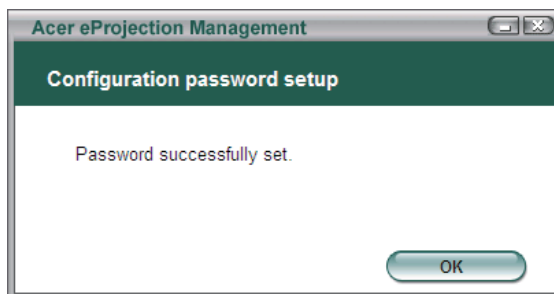

Once the password has been set, it needs to be entered before any changes can be made to the configuration of your Acer WPG.

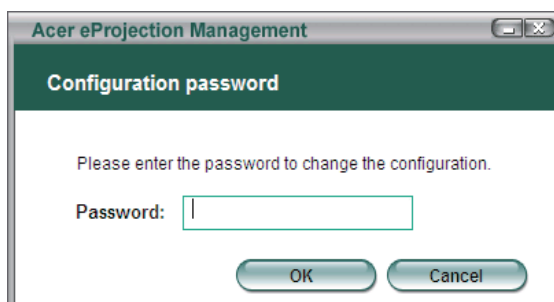

Wireless projection

You can also change or delete the password by clicking Configuration password setup.



Upgrade firmware

Click on this link to check if there is any newer firmware available. You will need to be connected to a network with an open Internet connection to do this.

Network settings

Click on this link to change the network settings.

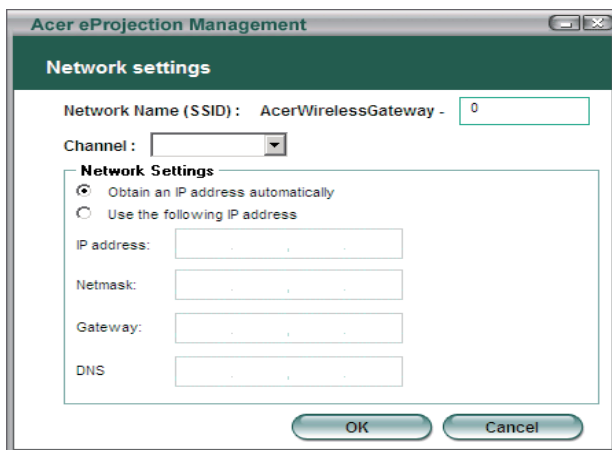

Here, you can set a customized SSID to identify the Acer WPG. You can also change the IP address – either set it to automatically obtain an IP address, or manually set a static IP address.

If necessary, you can set the RF channel used to connect with notebooks as well.

Wireless projection

Projection controls

Use the projection controls to perform various functions.



Hide

This feature projects a blank screen, so that you can make changes to a document, or refer to confidential information as needed, without your audience being able to see it.

Freeze

This feature freezes the projected image, so that you can make changes to a document, or refer to confidential information as needed, without your audience being able to see it.

Projector remote control

Through the WPG, you are able to carry out many of the same functions that the remote control allows you to perform, directly from your notebook.

Hotkey explanation

Click this button for a quick reminder of what the hotkey functions are.

<Ctrl> + <Shift> + <E> will toggle between full mode, and simplified mode:



Troubleshooting

If you experience trouble with the projector, refer to the following information. If the problem persists, please contact your local reseller or service center.

Problem: No image appears on screen.

- ▶ Ensure all the cables and power connections are correctly and securely connected as described in the "Installation" section.
- ▶ Ensure the pins of connectors are not crooked or broken.
- ▶ Check if the projection lamp has been securely installed. Please refer to the "Replacing the lamp" section.
- ▶ Make sure you have removed the lens cap and the projector is switched on.
- ▶ Ensure that the "Hide" feature is not enabled.

Problem: Partial, scrolling or incorrectly displayed image.

- ▶ Press the "Resync" button on the Remote Control.
- ▶ If you use a PC:
If the resolution of your computer is higher than 1024 x 768. Follow the steps outlined below to reset the resolution.

For Windows 3.x:

1. In the Windows Program Manager, click the "Windows Setup" icon in the Main group.
2. Verify that your display resolution setting is less than or equal to 1024 x 768.

For Windows 95, 98, 2000, XP:

1. Open "My Computer" icon, the "Control Panel" folder, and then double click on the "Display" icon.
2. Select the "Setting" tab.
3. In the "Desktop Area" you will find the resolution setting. Verify that the resolution setting is less than or equal to 1024 x 768 resolution.

If the projector is still not projecting the whole image, you will also need to change the monitor display you are using. Refer to the following steps.

4. Follow the above steps 1-2. Click on the "Advanced Properties" button.
5. Select the "Change" button under the "Monitor" tab .

Appendices

6. Click on "Show all devices". Then select "Standard monitor types" under the "Manufacturers" box ; choose the resolution mode you need under the "Models" box.
 7. Verify that the resolution setting of the monitor display is less than or equal to 1024 x 768.
- ▶ If you are using a Notebook PC:
 1. You are required to implement the above steps of resolution setting of the computer first.
 2. Switch the Notebook PC display to the "external display only" or "CRT only" mode.
 - ▶ If you experience difficulty in changing resolutions or your monitor freezes, restart all the equipment and the projector.

Problem: The screen of the Notebook or PowerBook computer is not displaying your presentation.

- ▶ If you are using a Notebook PC:
Some Notebook PCs may deactivate their screens when a second display device is in use. Refer to your computer's documentation for information on how to reactivate the monitor display.
- ▶ If you are using an Apple PowerBook:
In Control Panels, open the PowerBook Display to select Video Mirroring "On".

Problem: Image is unstable or flickering

- ▶ Use "Tracking" to correct it. Refer to page 25.
- ▶ Change the monitor color setting from your computer.

Problem: Image has vertical flickering bar

- ▶ Use "Frequency" to make an ad adjustment. Refer to page 25.
- ▶ Check and reconfigure the display mode of your graphic card to make it compatible with the product. Refer to page 27.

Problem: Image is out of focus

- ▶ Adjusts the Focus Ring on the projector lens. Refer to page 16.
- ▶ Make sure the projection screen is between the required distance 3.94 to 39.43 feet (1.2 to 12.02 meters) from the projector.

Appendices

Problem: The image is outstretched when displaying 16:9 DVD.

The projector automatically detects 16:9 DVD and adjusts the aspect ratio by digitizing to full screen with 4:3 default setting.

If the image is still outstretched, you will also need to adjust the aspect ratio by referring to the following:

- ▶ Please select 4:3 aspect ratio type on your DVD player if you are playing a 16:9 DVD.
- ▶ If you can't select 4:3 aspect ratio type on your DVD player, please select 4:3 aspect ratio in the on screen menu.







Problem: Image is reversed.

- ▶ Select "Image" from the OSD and adjust the projection direction. See page 24,25.

Problem: Lamp burns out or makes a popping sound

- ▶ When the lamp reaches its end of life, it will burn out and may make a loud popping sound. If this happens, the projector will not turn on until the lamp module has been replaced. To replace the lamp, follow the procedures in the "Replacing the Lamp". See page 50.

Problem: LED lighting message

Message	Power LED	Temp LED	Lamp LED
	Amber		
Standby State (Input power cord)	Slow Flashing	○	○
Lamp lighting		○	○
Power on		○	○
Power off (Cooling)	Quick Flashing	○	○
Error (Lamp fail)	○	○	
Error (Thermal fail)	Flashing		○
Error (Fan lock fail)	Flashing	Quick Flashing	○
Error (Over Temp.)	Flashing		○
Error (Lamp Breakdown)	○	○	

 =>Light On

○ =>Light Off

Replacing the lamp

The projector will detect the lamp life itself. It will show you a warning message "Lamp is approaching the end of its useful life in full power operation. Replacement Suggested!" When you see this message, changing the lamp as soon as possible. Make sure the projector has been cooled down for at least 30 minutes before changing the lamp.



Warning: Lamp compartment is hot! Allow it to cool down before changing lamp!

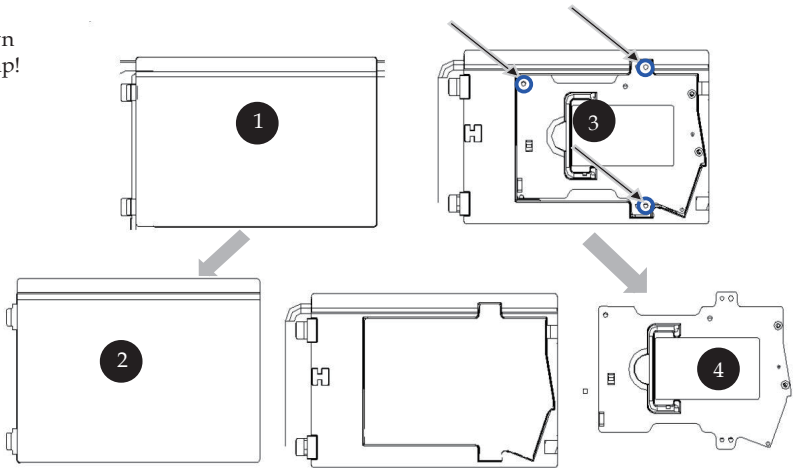

Warning: To reduce the risk of personal injury, do not drop the lamp module or touch the lamp bulb. The bulb may shatter and cause injury if it is dropped.

Lamp Changing Procedure:

1. Turn the power off the projector by pressing the Power button.
2. Allow the projector to cool down at least 30 minutes.
3. Disconnect the power cord.
4. Remove the cover. ①
5. Push up and remove the cover. ②
6. Remove the 3 screws from the lamp module. ③
7. Pull out the lamp module. ④

To replace the lamp module, reverse the previous steps.

Appendices

Problem: Message Reminders

- ▶ “Lamp is approaching the end of its useful life in full power operation. Replacement Suggested!” will be shown about 10 seconds when lamp life is going to deplete.
- ▶ “Projector Overheated. Lamp will automatically turn off soon.” will be shown when the system temperature is over heat.
- ▶ “Fan fail. Lamp will automatically turn off soon.” will be shown when the fan is out of order.

Specifications

The specs specified below are subject to change without notice. Regarding the final specs, please refer to Acer announced marketing specs.

Light Valve	- Single Chip DLP™ Technology by Texas Instruments
Lamp	- 260W User Replaceable Lamp for PD724 - 300 W User Replaceable Lamp for PD726
Number of Pixels	- 1024 pixels(H) X 768 lines(V)
Displayable Color	- 16.7M colors
Contrast Ratio	- 2500:1 (Full On/Full Off)
Uniformity	- 90%
Noise Level	- 28dB(A)(standard mode / 26dB(A)(ECO mode) for PD724 - 30dB(A)(standard mode / 28dB(A)(ECO mode) for PD726
Projection Lens	- F/2.4~2.6 f=28.0~33.6mm with 1.2X Manual zoom lens
Projection Screen Size (Diag.)	- 25 to 300 inches Diagonal
Projection Distance	- 3.94 to 39.43 feet (1.2 to 12.02 meters)
Video Compatibility	- NTSC 3.58/NTSC 4.43/PAL/SECAM and HDTV compatible - Composite video & S-Video capability
H. Frequency	- 31.5kHz~100kHz horizontal scan
V. Frequency	- 56Hz~85Hz vertical refresh
Power Supply	- Universal AC input 100-240V ; Input Frequency 50/60Hz
I/O Connectors	- Power: AC power input socket - One DVI connector - One 15-pin D-sub for VGA, component and HDTV signal - One HDMI input for Digital Video input - RS232: For projector remote control - VGA Output: One 15-pin D-sub - Video Input: ▪ One Composite video RCA input ▪ One S-Video input ▪ One set (3 RCA) of component input - USB:One USB connector - Audio Input: One phone jack for audio input - Audio Output: One phone jack for wireless audio output <i>(for PD724W/PD726W only)</i> - Lan Output: One Lan port (RJ45 connector for 10/100M Ethernet) <i>(for PD724W/PD726W only)</i>
Weight	- 7.6 lbs (3.5kg)
Dimensions (W x H x D)	- 13.9 x 11.10 x 4.68 inches (350 x 282 x 119 mm)
Environmental	- Operating Temperature: 41~95° F (5~ 35° C) Humidity: 80% maximum (Non-condensing) - Storage Temperature: -4~140 F (-20~60° C) Humidity: 80% maximum (Non-condensing)
Safety Regulation	- FCC Class B, CE Class B, VCCI-II,ETL, cETL, ETL-GS, C-tick, PSB, PSE, CB Report, CCC

Compatibility Modes

Modes	Resolution	V.Frequency [Hz]	H.Frequency [KHz]
VGA - Analog			
VGA	640x480	60	31.5
	640x480	72	37.9
	640x480	75	37.5
	640x480	85	43.3
	720x400	70	31.5
	720x400	85	37.9
SVGA	800x600	56	35.2
	800x600	60	37.9
	800x600	72	48.1
	800x600	75	46.9
	800x600	85	53.7
XGA	1024x768	60	48.4
	1024x768	70	56.5
	1024x768	75	60.0
	1024x768	85	68.7
SXGA	1152x864	70	63.8
	1152x864	75	67.5
	1152x864	85	77.1
	1280x1024	60	63.98
	1280x1024	72	76.97
	1280x1024	75	79.98
QuadVGA	1280x960	60	59.7
QuadVGA	1280x960	75	75.23
SXGA+	1400x1050	60	63.98
MAC LC 13"	640x480	66.66	34.98
MAC II 13"	640x480	66.68	35
MAC 16"	832x624	74.55	49.725
MAC 19"	1024x768	75	60.24
MAC	1152x870	75.06	68.68
MAC G4	640x480	60	31.35
i Mac DV	1024x768	75	60
i Mac DV	1152x870	75	68.49
i Mac DV	1280x960	75	75
VGA - Analog - Extended Wide timing			
WXGA	1280 x 768	60	48.36
	1280 x 768	75	57.6
	1280 x 768	85	68.63
	1360 x 768	60	47.72
DVI - Digital			
VGA	640x480	60	31.5
	640x480	72	37.9
	640x480	75	37.5
	640x480	85	43.3
	720x400	70	31.5
	720x400	85	37.9

Appendices

Modes	Resolution	V.Frequency [Hz]	H.Frequency [KHz]
DVI - Digital			
SVGA(Compressed)	800x600	56	35.2
	800x600	60	37.9
	800x600	72	48.1
	800x600	75	46.9
	800x600	85	53.7
XGA(Native)	1024x768	43.4	35.5
	1024x768	60	48.4
	1024x768	70	56.5
	1024x768	75	60.0
	1024x768	85	68.7
SXGA(Compressed)	1152x864	70	63.8
	1152x864	75	67.5
	1152x864	85	77.1
	1280x1024	60	63.98
	1280x1024	75	79.98
	1280x1024	85	91.1
SXGA+(Compressed)	1400x1050	60	63.98
UXGA(Compressed)	1600x1200	60	75
HDMI - Digital			
(1) PC Signal.	*Support above DVI digital timing format.		
(2) Video Signal.			
480i	704 x 480	59.94(29.97)	15.73
480p	704 x 480	59.94	31.47
576i	720 x 576	50(25)	15.63
576p	720 x 576	50	31.25
720p	1280 x 720	60	45.00
720p	1280 x 720	50	37.5
1080i	1920 x 1080	60(30)	33.75
YPbPr - Analog			
480i	704 x 480	59.94(29.97)	15.73
480p	704 x 480	59.94	31.47
576i	720 x 576	50(25)	15.63
576p	720 x 576	50	31.25
720p	1280 x 720	60	45.00
720p	1280 x 720	50	37.5
1080i	1920 x 1080	60(30)	33.75

Regulation & safety notices

This appendix lists the general notices of your Acer Projector.

FCC notice

This device has been tested and found to comply with the limits for a Class B digital device pursuant to Part 15 of the FCC rules. These limits are designed to provide reasonable protection against harmful interference in a residential installation. This device generates, uses, and can radiate radio frequency energy and, if not installed and used in accordance with the instructions, may cause harmful interference to radio communications.

However, there is no guarantee that interference will not occur in a particular installation. If this device does cause harmful interference to radio or television reception, which can be determined by turning the device off and on, the user is encouraged to try to correct the interference by one or more of the following measures:

- Reorient or relocate the receiving antenna.
- Increase the separation between the device and receiver.
- Connect the device into an outlet on a circuit different from that to which the receiver is connected.
- Consult the dealer or an experienced radio/television technician for help.

Notice: Shielded cables

All connections to other computing devices must be made using shielded cables to maintain compliance with FCC regulations.

Caution

Changes or modifications not expressly approved by the manufacturer could void the user's authority, which is granted by the Federal Communications Commission, to operate this computer.

Operation conditions

This device complies with Part 15 of the FCC Rules. Operation is subject to the following two conditions:

1. this device may not cause harmful interference, and
2. this device must accept any interference received, including interference that may cause undesired operation.

Notice: Canadian users

This Class B digital apparatus complies with Canadian ICES-003.

Remarque à l'intention des utilisateurs canadiens

Cet appareil numérique de la classe B est conforme à la norme NMB-003 du Canada.

Declaration of Conformity for EU countries

Hereby, Acer, declares that this Acer projector is in compliance with the essential requirements and other relevant provisions of Directive 1999/5/EC. (Please visit [http:// global.acer.com](http://global.acer.com).)

Compliant with Russian regulatory certification



ME61

Important safety instructions

Read these instructions carefully. Save them for future reference.

1. Follow all warnings and instructions marked on the product.
2. Unplug this product from the wall outlet before cleaning. Do not use liquid cleaners or aerosol cleaners. Use a water-moistened cloth for cleaning.
3. Do not use this product near water.
4. Do not place this product on an unstable cart, stand or table. If the product falls, it could be seriously damaged.
5. This product should be operated from the type of power indicated on the marking label. If you are not sure of the type of power available, consult your dealer or local power company.
6. Do not allow anything to rest on the power cord. Do not locate this product where people will walk on the cord.
7. Never push objects of any kind into this product through cabinet slots as they may touch dangerous voltage points or short-out parts that could result in a fire or electric shock. Never spill liquid of any kind onto or into the product.
8. Do not attempt to service this product yourself, as opening or removing covers may expose you to dangerous voltage points or other risks. Refer all servicing to qualified service personnel.
9. Unplug this product from the wall outlet and refer servicing to qualified service personnel under the following conditions:
 - a. When the power cord or plug is damaged or frayed.
 - b. If liquid has been spilled into the product.
 - c. If the product has been exposed to rain or water.
 - d. If the product does not operate normally when the operating instructions are followed. Adjust only those controls that are covered by the operating instructions, since improper adjustment of other controls may result in damage and will often require extensive work by a qualified technician to restore the product to normal condition.
 - e. If the product has been dropped or the case has been damaged. If the product exhibits a distinct change in performance, indicating a need for service.
10. To avoid hazard of unexpected electrical shock, use the AC adapter only when the wall socket is properly grounded.

Canada – Low-power license-exempt radio communication devices (RSS-210)

- a. Common information Operation is subject to the following two conditions:
 1. This device may not cause interference, and
 2. This device must accept any interference, including interference that may cause undesired operation of the device.
- b. Operation in 2.4 GHz band To prevent radio interference to the licensed service, this device is intended to be operated indoors and installed outdoors is subject to licensing.