

***myprojectorlamps.com***

**The most trusted, dependable name  
in projector lamp sales.**



<http://www.myprojectorlamps.com>



<http://www.myprojectorlamps.ca>



<http://www.myprojectorlamps.eu>

The following projector manual has not been modified or altered in any way.

# Table of Contents

## Usage Notice

Precautions .....	2
-------------------	---

## Introduction

Product Features .....	4
Package Overview .....	5
Product Overview .....	6
<i>Main Unit</i> .....	6
<i>Panel Control</i> .....	8
<i>Connection Ports</i> .....	9
<i>Remote Control with Mouse Function</i> .....	10

## Installation

Connecting the Projector .....	11
Powering On/Off the Projector .....	12
<i>Powering On the Projector</i> .....	12
<i>Powering Off the Projector</i> .....	13
Adjusting the Projected Image .....	14
<i>Adjusting the Projector Height</i> .....	14
<i>Adjusting the Projector Focus</i> .....	15

## User Controls

Panel Control & Remote Control .....	16
On Screen Display Menus .....	19
<i>How to Operate</i> .....	19
<i>User's Info</i> .....	20
<i>Image-I (Computer Mode)</i> .....	22
<i>Image-II (Computer Mode)</i> .....	23
<i>Image-I (Video Mode)</i> .....	24
<i>Image-II (Video Mode)</i> .....	25
<i>Language (Computer / Video Mode)</i> .....	26
<i>Management (Computer / Video Mode)</i> .....	27









## Appendices

Troubleshooting .....	28
Changing the Lamp .....	31
Specifications .....	33
Compatibility Modes .....	34

# Usage Notice

## Precautions

*Follow all warnings, precautions and maintenance as recommended in this user guide to maximize the life of your unit.*

-  **Warning-** Do not look into the lens. The bright light may hurt your eyes.
-  **Warning-** To reduce the risk of fire or electric shock, do not expose this product to rain or moisture.
-  **Warning-** Please do not open or disassemble the product as this may cause electric shock.
-  **Warning-** When changing the lamp, please allow unit to cool down, and follow all changing instructions.
-  **Warning-** This product will detect the life of the lamp itself. Please be sure to change the lamp when it shows warning messages.
-  **Warning-** After changing a new lamp please reset the lamp life from OSD menu.
-  **Warning-** Before switching off the product, please keep the cooling fan running for a few minutes.
-  **Warning-** When connecting the projector to the computer, please turn off the projector first.
-  **Warning-** When the lamp reaches the end of its life, it will burn out and may make a loud popping sound. If this happens, the projector will not turn back on until the lamp module has been replaced. To replace the lamp, follow the procedures listed under “Changing the Lamp.”

# Usage Notice

## *Do:*

- ❖ Turn off the product before cleaning.
- ❖ Use a soft cloth moistened with mild detergent to clean the display housing.
- ❖ Disconnect the plug from power outlet if the product is not being used for a long period of time.

## *Do not:*

- ❖ Block the slots and openings on the unit provided for ventilation.
- ❖ Use abrasive cleaners, waxes or solvents to clean the unit.
- ❖ Operate under the following conditions:
  - Extremely hot, cold or humid environments.
  - In areas susceptible to excessive dust and dirt.
  - Near any appliance generating a strong magnetic field.
  - Place in direct sunlight.

# Introduction

## Product Features

*This product is an SVGA single chip 0.55" DLP™ projector. Its outstanding features include:*

- ◆ True SVGA, 800 x 600 addressable pixels
- ◆ 4.5 lbs (2 kgs) compact design
- ◆ Single chip DLP™ technology
- ◆ Independent white-balance adjustment, for natural picture quality
- ◆ Digital zoom features
- ◆ PureProgressive™ processing technology for artifact-free film materials
- ◆ Full HDTV compatibility (480i/p, 1080i, 720p)
- ◆ NTSC/NTSC4.43/PAL/PAL-M/PAL-N/SECAM and HDTV compatible
- ◆ Fully functioning remote with optional mouse control
- ◆ User-friendly multilingual on screen display menu
- ◆ Advanced electronic keystone correction and high quality full digital functionality
- ◆ User-friendly control panel
- ◆ Luxurious carrying bag included
- ◆ When set to the smallest ratio, the projector can support up to SXGA and can fully support VGA and SVGA
- ◆ 150 watt user replaceable lamp
- ◆ Compatible with Apple Macintosh

# Introduction

## Package Overview

*This projector comes with all the items shown below. Check to make sure your unit is complete. Contact your dealer immediately if anything is missing.*

Projector with lens cap



VGA Cable



Power Cord



D-15 to RCA-Adapter  
for YPbPr



S-Video Cable



User's Guide

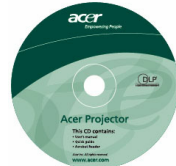

Carrying Case



Quick Start Card



Warranty Card



Battery x 2



Remote Control with  
Mouse Function



# Introduction

## Product Overview

### Main Unit

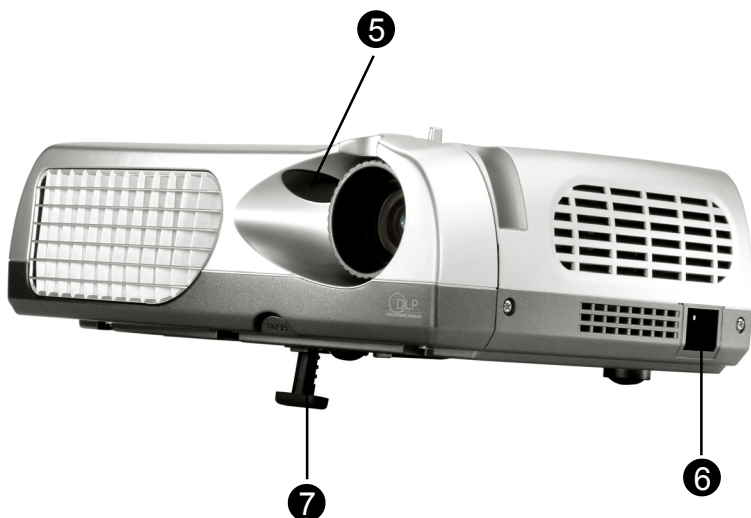

# Introduction



- 
1. Panel Control
  2. Focus Ring
  3. Lens
  4. Elevator Button
  5. Remote Control Receiver
  6. Power Connector
  7. Elevator Foot
  8. Connection Ports
-



# Introduction

## Panel Control

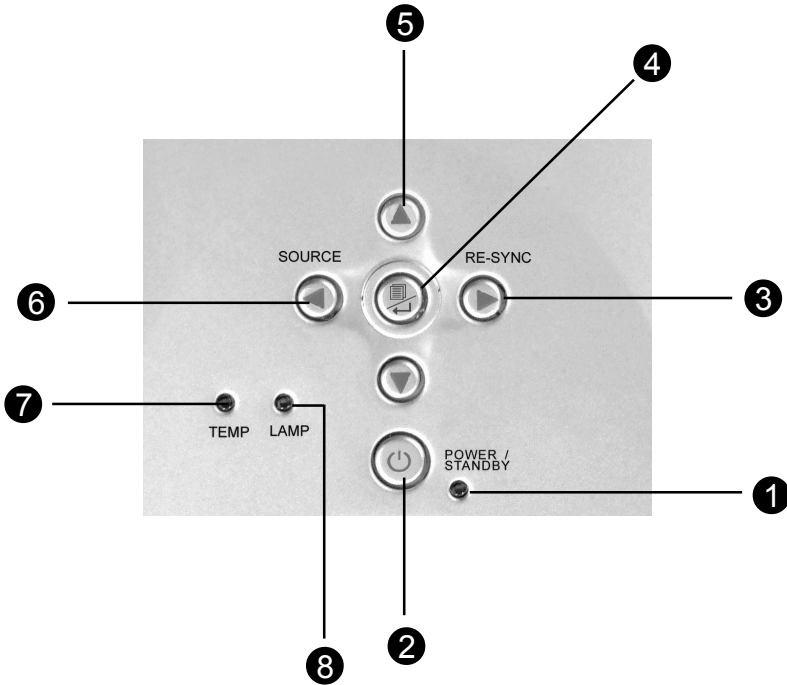

- 
1. Power Indicator Light
  2. Power / Standby
  3. Re-sync
  4. Menu On / Off ; Enter
  5. Four Directional Select Keys
  6. Source
  7. Temperature Warning LED
  8. Lamp Warning LED
-

# Introduction

## Connection Ports

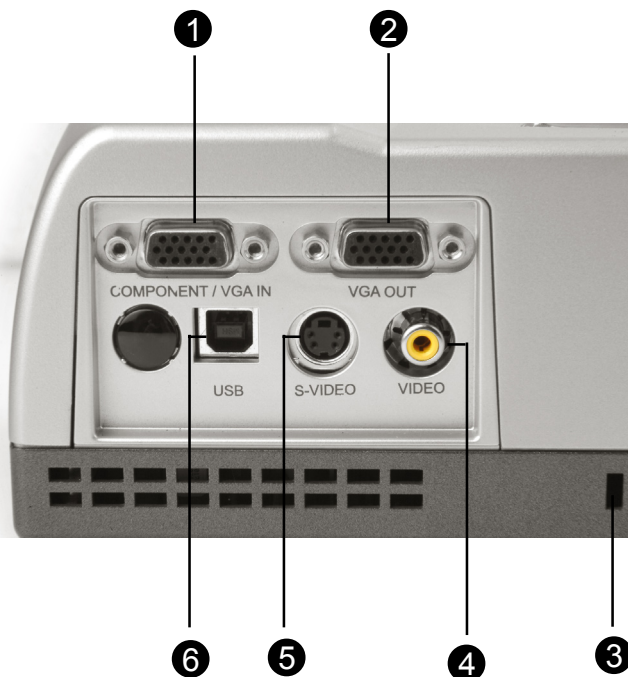

- 
1. Connector for computer / component signal input
  2. Connector for external monitor signal output
  3. Kensington™ Lock
  4. Composite Video Input Connector
  5. S-Video Input Connector
  6. USB Mouse connector port
-

# Introduction

## Remote Control with Mouse Function

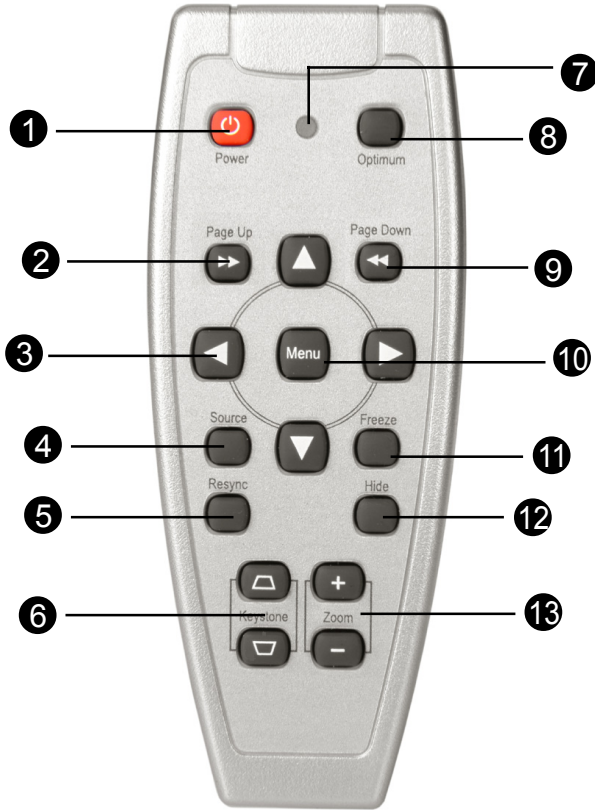

- 
- |                              |                        |
|------------------------------|------------------------|
| 1. Power / Standby           | 7. LED                 |
| 2. Page Up                   | 8. Optimum Setting     |
| 3. Four Directional Selector | 9. Page Down           |
| 4. Source                    | 10. Menu               |
| 5. Re-sync                   | 11. Freeze             |
| 6. Keystone Correction       | 12. Hide               |
|                              | 13. Zoom In / Zoom Out |
-

# Installation

## Connecting the Projector

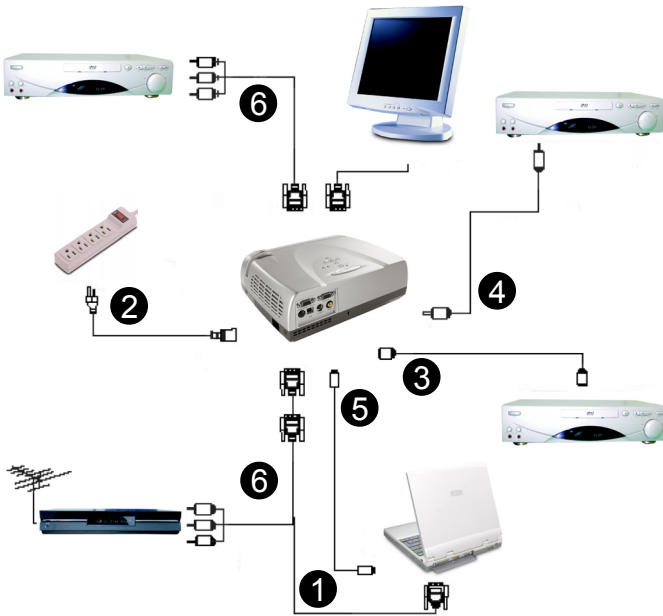

- 
1. VGA Cable
  2. Power Cord
  3. S-Video Cable
  4. Composite Video Cable (optional)
  5. USB Cable (to connect the USB mouse to a PC; optional)
  6. HDTV/Component Video Cable (optional)
- 

❖ *To ensure the projector works well with your computer, please set the display mode on your graphics card to less than or equal to SVGA (800 x 600) resolution. Also ensure the refresh rate of the graphics card is compatible with the projector. Refer to the “Compatibility Modes” section on page 34 for more information.*

# Installation

## Powering On/Off the Projector

### Powering On the Projector

1. Remove the lens cap.
2. Ensure that the power cord and signal cable are securely connected.
3. Turn on the lamp by pressing “Power/Standby” on the control panel. ❶  
The startup screen will be displayed for 20 seconds and the Power/Standby indicator will turn solid green.
4. Turn on the source (computer, notebook, or video player, etc.) The projector will automatically detect your source.
  - ❖ *If the projector displays “Searching...” please make sure the signal cables are securely connected.*
  - ❖ *If connecting multiple sources at the same time, use the “Source” button on the remote control or projector control panel to select the desired input. Press the “Source” button repeatedly until the desired input is displayed.*
  - ❖ *Turn on the projector first and then the computer.*



# Installation

## Powering Off the Projector

1. Press “Power/Standby” to turn off the projector lamp. The projector will display the message “Power off the lamp?”
  2. Press “Power/Standby” again to confirm. Otherwise the message will disappear after 5 seconds.
  3. “Power/Standby” indicator will turn green for approximately 90 seconds. When the green light begins flashing, the projector has entered standby mode. If you wish to turn the projector back on, you must wait until the projector has completed the 90-second cooling cycle and has entered standby mode. Once in standby mode, simply press “Power/Standby” to restart the projector.
  4. Disconnect the power cord from the electrical outlet and the projector.
  5. Do not turn on the projector immediately following a power off procedure.
- ❖ *If the “TEMP” indicator begins flashing the projector will display a “Fan Fail” warning. After a short period the “Power/Standby” indicator will flash green for about 90 seconds and the projector will automatically shut itself down. If this occurs please contact your local reseller or service center.*
  - ❖ *If the “TEMP” indicator turns red it indicates the projector has overheated. The projector will display “Over Temperature. After a short period the “Power/Standby” indicator will turn green and the projector will automatically shut itself down. If this occurs please contact your local reseller or service center.*
  - ❖ *If the “LAMP” indicator turns red and the “Power/Standby” indicator turns amber, the projector will automatically shut itself down. If this occurs please contact your local reseller or service center.*

# Installation

## Adjusting the Projected Image

### Adjusting the Projector Height

*The projector is equipped with an elevator foot for adjusting the projector height.*

#### To raise the projector:

1. Press the elevator button ❶.
2. Raise the projector to the desired display angle ❷, then release the button to lock the elevator foot into position.
3. Use ❸ to fine-tune tilt adjustment.

#### To lower the projector:

1. Press the elevator button ❶.
2. Lower the projector then release the button ❷ to lock the elevator foot into position.
3. Use ❸ to fine-tune tilt-adjustment.

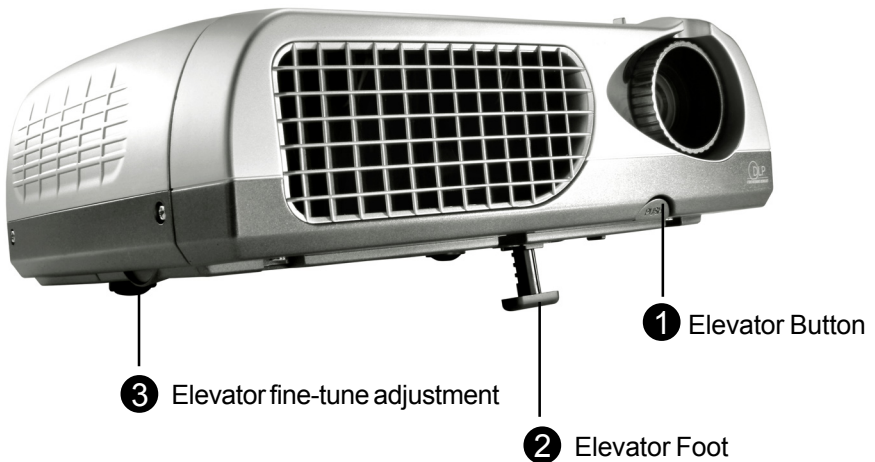

# Installation

## Adjusting the Projector Focus

To adjust the focus, simply rotate the focus ring until the image is clear. The projector will focus at distances from 4.0 feet to 39.4 feet (1.2m to 12m)

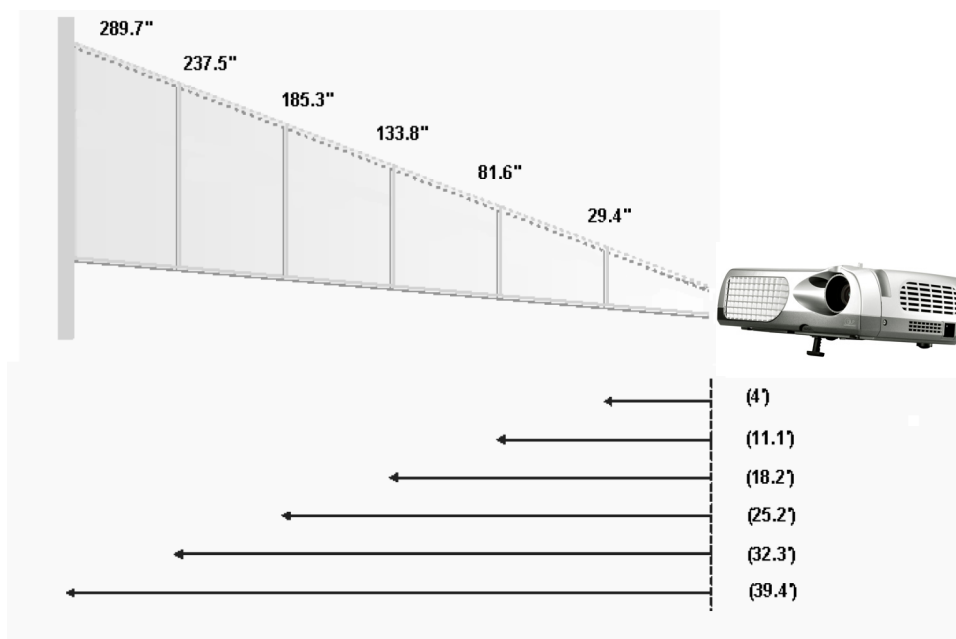

Screen (Diagonal)	29.4"	81.6"	133.8"	185.3"	237.5"	289.7"
Screen Size (WxH)	23.5 x 17.7"	65.3 x 48.9"	107.1 x 80.3"	148.2 x 111.2"	190.0 x 142.5"	231.8 x 173.8"
Distance	4.0'	11.1'	18.2'	25.2'	32.3'	39.4'

❖ This graph is for reference only.



# User Controls

## Panel Control & Remote Control

*There are two options for controlling the projector: Remote Control and Panel Control.*

**Panel Control**

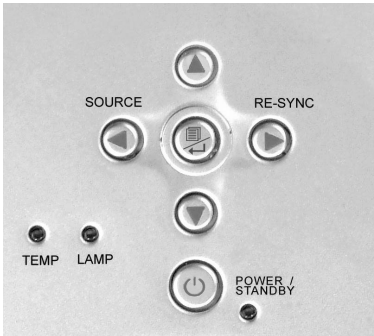

**Remote Control**



### Remote Control

#### Power / Standby

Refer to the “Power On/Off the Projector” section on page 12-13.

#### Optimum Setting

- ▶ Press “Optimum” to select Conference Mode or Cinema Mode.

#### Source

- ▶ Press “Source” to cycle between VGA, S-Video, Composite, and Component sources.

# User Controls

## Four Directional Selectors

- ▶ These keys are used to control the direction ▲▼◀▶ operation on the OSD display.

## Page Up (Computer Mode only)

- ▶ Use this button to page up. This function is only available when the projector is connected to a computer via an USB cable.

## Page Down (Computer Mode only)

- ▶ Use this button to page down. This function is only available when the projector is connected to a computer via a USB cable.

## Menu

- ▶ Press “Menu” to launch the OSD menu and press ◀▶ key to select menu items. To exit the OSD, press “Menu” again. The projector will automatically save any changes you made.

## Freeze

- ▶ Press “Freeze” to pause the screen image.

## Keystone + / -

- ▶ Adjusts image distortion caused by tilting the projector. ( $\pm 16$  degrees)

## Re-sync

- ▶ When “Re-sync” is pressed, the projector will automatically synchronize with the source signal.

## Hide

- ▶ Pressing “Hide” will turn the entire screen black, a useful function for speakers who require a short pause in order to change their presentation materials.

# User Controls

## Use the Panel Control

### Power/Standby

- ▶ Refer to the ‘Power On/Off the Projector’ section on page 12-13.

### Source

- ▶ Press “Source” to cycle through VGA, S-Video, Composite and Component sources.

### Re-Sync

- ▶ Automatically synchronizes the projector to the input source.

### Four Directional Select Keys

- ▶ Use ▲▼◀▶ to select items or make adjustments for your selection.

### Enter

- ▶ Confirm your selection of items.
- ▶ Press “Menu” to launch the OSD menu and press ◀▶ key to select menu items. To exit the OSD, press “Menu” again. The projector will automatically save any changes you made.

# User Controls

## OSD Menus

### How to Operate

- ▶ The projector has a multilingual OSD that allows you to make image adjustments and change a variety of settings. With a computer source, the OSD displayed is the “Computer OSD”. With a video source, the OSD displayed is the “Video OSD”. The projector will automatically detect the source.
  - ▶ To launch the OSD menu, press “Menu” on the remote control or panel control.
  - ▶ When the OSD is displayed, press ◀▶ key to select main items.  
E.g.: Image-I→Image-II→Language→Management→Image-I...
- While making selection on a particular page, press “ Menu / ← ” key to go into the sub menu.
- ▶ Press ▲▼ key to select the required item and adjust the settings by ◀▶ key. When a specified item is selected, the color of the item will change from yellowish brown to blue.  
E.g.: Brightness→Contrast→Color Temp.→Zoom→Keystone→  
White segment→Brightness...
  - ▶ When using the ◀▶ keys to adjust parameters or select desired sub menu functions, confirm selections/modifications by pressing “ Menu / ← ” to revert back to the main menu. Only the ◀▶ keys are enabled now.
  - ▶ To exit the OSD, press the “ Menu / ← ” button again.

# User's Info

Edits user preferences by OSD interface. Press "Menu" to enter "User's info." screen, you can edit as you wish. Edited User's info will display on lower left corner of the screen when projector is powered ON.

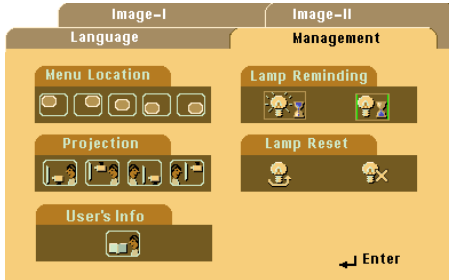

# acer

*Empowering People*

MY PERSONAL/COMPANY INFO: LINE 1  
MY PERSONAL/COMPANY INFO: LINE 2

1. Use the ◀▶ to select "Line1" function, and then press the "Menu" button. You can input the character to line one.
2. Use the ▲▼◀▶ to select character, and then press "Menu" to confirm your selection.
3. Use the ◀▶ to select "Line2" function, and then press the "Menu" button. You can input the character to line two.

# User's Info

4. Procedure as Step.3.
5. Press " " to save and exit the "User's info." menu.
6. The startup screen will display the new wording after restart the projector.

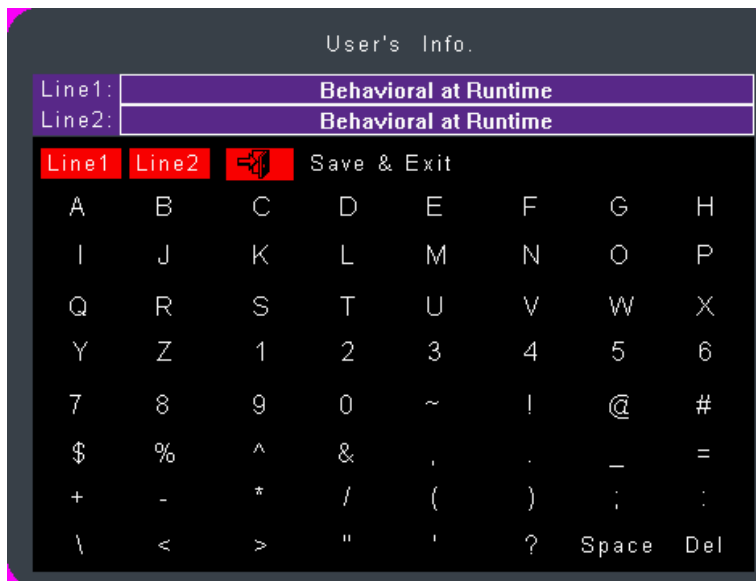

## Note:

- ▶ Each line can input 35 characters only.
- ▶ Once entering "User's info." menu can use remote control to operate only.
- ▶ Use "Del" to delete the previous character.
- ▶ Use "Space" to add a space.

# User Controls

## Computer Mode

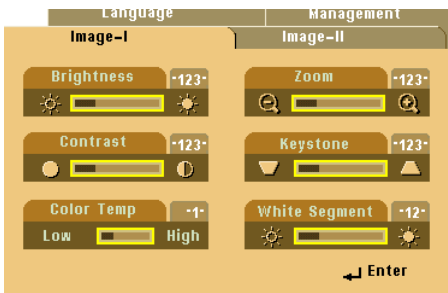

*Image-I*

### Brightness

Adjusts the brightness of the image.

- ▶ Press ◀ to darken image.
- ▶ Press ▶ to lighten the image.

### Contrast

The contrast controls the degree of difference between the lightest and darkest parts of the picture. Adjusts the contrast changes the amount of black and white in the image.

- ▶ Press ◀ to decrease the contrast.
- ▶ Press ▶ to increase the contrast.

### Color Temperature

Adjusts the color temperature. The range is from “0” to “4”, the factory default is “2”. With the higher temperature, the screen looks colder; with the lower temperature, the screen looks warmer.

### Zoom

- ▶ Press ◀ to magnify an image up to a factor of eight times on the projection screen.
- ▶ Press ▶ to diminish the zoom in image. Lowest available setting is 1/2-size.

### Keystone (Keystone Correction)

Adjusts image distortion caused by tilting projection. (±16 degrees)

### White Segment

Use the white segment control to set the white peaking level of the DMD chip. “0” stands for minimal peaking, and “10” stands for maximum peaking. If you prefer a stronger image, adjust toward the maximum setting. For a smooth and more natural image, adjust toward the minimum setting.

# User Controls

## Computer Mode

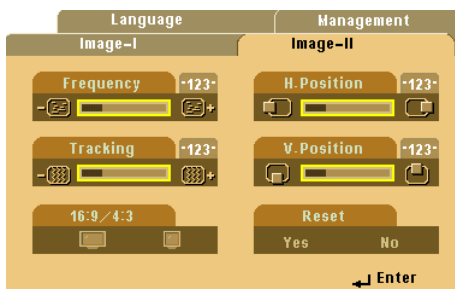

*Image-II*

### Frequency

“Frequency” is for changing the display data frequency to match the frequency of your computer’s graphic card. When you experience a vertical flickering bar, use this function to make an adjustment.

### Tracking

Choose “Tracking” to synchronize the signal timing of the display with that of the graphic card. When you experience an unstable or flickering image, use this function to correct it.

### 16:9/4:3 (Aspect Ratio)

You can use this function to select your desired aspect ratio.

### H.Position (Horizontal Position)

- ▶ Press ◀ to move the image left.
- ▶ Press ▶ to move the image right.

### V.Position (Vertical Position)

- ▶ Press ◀ to move the image up.
- ▶ Press ▶ to move the image down.

### Reset

Choose “Yes” to return the display parameters back to factory default.



❖ “Reset” returns all settings in Image-I and Image-II to factory defaults.



# User Controls

## Video Mode



### *Image-I*

#### **Brightness**

Adjusts the brightness of the image.

- ▶ Press ◀ to darken the image.
- ▶ Press ▶ to lighten the image.

#### **Contrast**

The contrast controls the degree of difference between the lightest and darkest parts of the picture. Adjusts the contrast changes the amount of black and white in the image.

- ▶ Press ◀ to decrease the contrast.
- ▶ Press ▶ to increase the contrast.

#### **Color**

The color setting adjusts a video image from black and white to fully saturated color.

- ▶ Press ◀ to decrease the amount of color in the image.
- ▶ Press ▶ to increase the amount of color in the image.

#### **Tint**

The tint adjusts the color balance of red and green.

- ▶ Press ◀ to increase the amount of green in the image.
- ▶ Press ▶ to increase the amount of red in the image.

#### **Sharpness**

Adjusts the sharpness of the image.

- ▶ Press ◀ to decrease the sharpness.
- ▶ Press ▶ to increase the sharpness.

#### **White Segment**

Use the white segment control to set the white peaking level of DMD chip. "0" stands for minimal peaking, and "10" stands for maximum peaking. If you prefer a stronger image, adjust toward the maximum setting. For a smooth, more natural image, adjust toward the minimum setting.

# User Controls

## Video Mode



*Image-II*

### Keystone

Adjust image distortion caused by tilting the projector. ( $\pm 16$  degrees)

### 16:9/4:3 (Aspect Ratio)

You can use this function to select your desired aspect ratio.

### Zoom

You can use this function to adjust the screen to the most appropriate size or to enlarge a particular area. You can also use  $\blacktriangle \blacktriangledown \blacktriangleleft \blacktriangleright$  to change the area you want to enlarge.

### Color Temp.

Adjusts the color temperature. The range is from "0" to "4". The factory default is "2". At a higher temperature, the image is cooler, at a lower temperature, the image is warmer.

### Reset

Choose "Yes" to return the display parameters back to factory default.



❖ "Reset" returns all settings in Image-I and Image-II to factory defaults.

# User Controls

## Computer / Video Mode



### *Language*

#### **Language**

You can display the multilingual OSD menu. Use ▲ and ▼ to select your preferred language.

# User Controls

## Computer / Video Mode

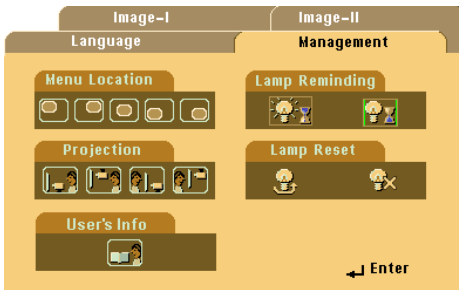

### *Management*

#### **Menu Location**

Choose the Menu location on the display screen.

#### **Projection**

##### ▶ **Front-Desktop**

The factory default setting.

##### ▶ **Rear-Desktop**

When you select this function, the projector reverses the image so you can project behind a translucent screen.

##### ▶ **Front-Ceiling**

When you select this function, the projector turns the image upside down for ceiling-mounted projection.

##### ▶ **Rear-Ceiling**

When you select this function, the projector reverses and turns the image upside down at same time. You can project from behind a translucent screen with ceiling mounted projection.

#### **Lamp Reminding**

Choose this function to show or to hide the warning message when the changing lamp message is displayed. The message will display up to 30 hours before end of life.

#### **Lamp Reset**

Reset the lamp setting only when the new lamp is replaced.

# Appendices

## Troubleshooting

*If you experience trouble with the projector, refer to the following. If the problem persists, please contact your local reseller or service center.*

### **Problem: No image appears on screen.**

- ▶ Ensure all the cables and power connections are correctly and securely connected as described in the “Installation” section.
- ▶ Ensure the pins of connectors are not crooked or broken.
- ▶ Check if the projection lamp has been securely installed. Please refer to the “Changing the lamp” section.
- ▶ Make sure you have removed the lens cap and the projector is switched on.
- ▶ If you are using a Notebook PC:
  1. First set computer resolution to recommend setting.
  2. Switch the Notebook PC display to the “external display only” or “CRT only” mode.
- ▶ If you experience difficulty change resolutions or your monitor freezes, restart all the equipment and the projector.

# Appendices

## **Problem: The screen of the notebook or PowerBook computer is not displaying your presentation.**

- ▶ If you are using Notebook PC:

Some Notebook PCs may deactivate their own monitor's screen when a second display device is in use. Each of them has a different way to be reactivated. Refer to your computer documentation for detailed information.

- ▶ If you are using an Apple PowerBook:

In Control Panels, open the PowerBook Display to select Video Mirroring "On".

## **Problem: Image is unstable or flickering**

- ▶ Use "Tracking" to correct it.
- ▶ Change the monitor color setting from your computer.

## **Problem: Image has vertical flickering bar**

- ▶ Use "Frequency" to make an adjustment.
- ▶ Check and reconfigure the display mode of your graphic card to make it compatible with the product.

## **Problem: Image is out of focus**

- ▶ Adjust the Focus Ring on the projector lens.
- ▶ Make sure the projection screen is placed within recommended range of 1.9 to 39.4 feet (0.6 m to 12 meters).

# Appendices

## **Problem: The image is distorted when displaying 16:9 DVD.**

The projector itself will automatically detect 16:9 DVD and adjust the aspect ratio by digitizing to full screen with 4:3 default setting.

If the image is still distorted, you will also need to adjust the aspect ratio by referring to the following:

- ▶ Please select 4:3 aspect ratio type on your DVD player if you are playing a 16:9 DVD.
- ▶ If you can select 4:3 aspect ratio type on your DVD player, please select 4:3 OSD function of the projector for your display.

## **Problem: Image is reversed.**

- ▶ Open “Menu” then select “Management” to adjust the projection.

## **Problem: Lamp burns out or makes a popping sound**

- ▶ When the lamp reaches its end of life, it will burn out and may make a loud popping sound. If this happens, the projector will not turn back on until the lamp module has been replaced. To replace the lamp, following the procedures in the “Changing the Lamp”.

# Appendices

## Changing the lamp

The projector will detect the lamp life itself. It will show you a warning message “Lamp may fail soon! Replacement Suggested!” When you see this message, change the lamp as soon as possible.

Make sure the projector has cooled down for at least 30 minutes before changing the lamp.

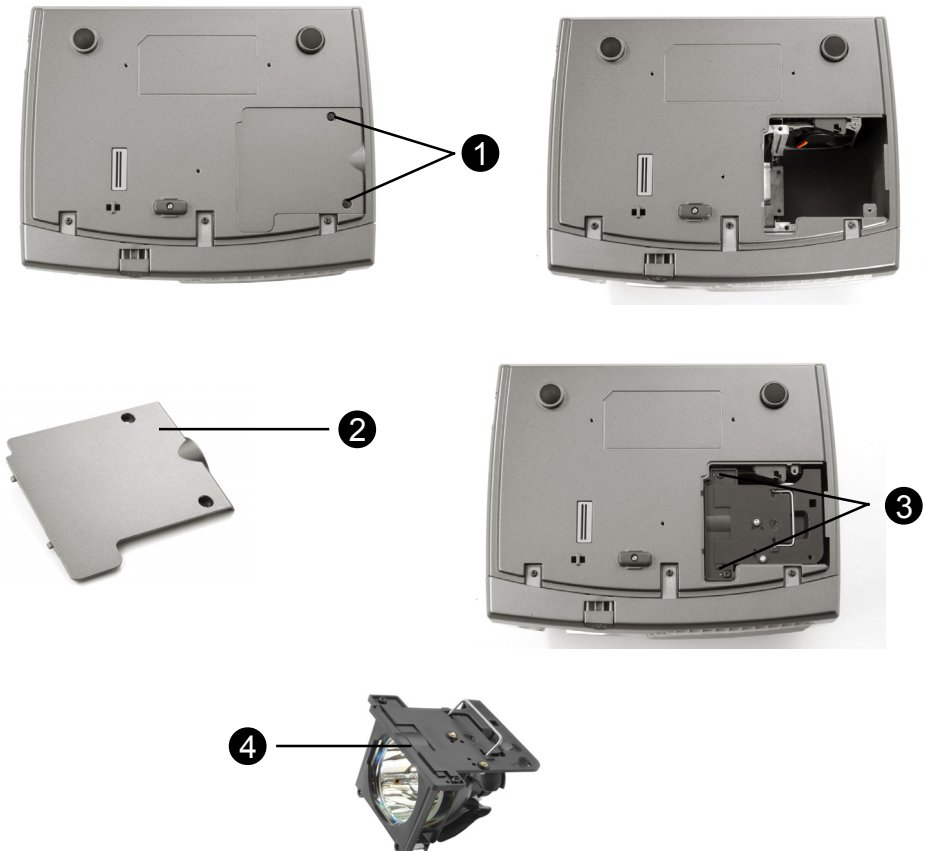



# Appendices

Lamp Changing Procedure:

1. Turn off the power to the projector by pressing the Power/Standby button.
2. Allow the projector to cool down at least 30 minutes.
3. Disconnect the power cord.
4. Use screwdriver to remove the screw from the cover. ❶
5. Remove the cover. ❷
6. Remove the 2 screws from the lamp module. ❸
7. Pull out the lamp module. ❹

**To replace the lamp module, reverse the previous steps.**



*Warning: Lamp compartment is hot! Allow it to cool down before changing lamp!*



*Warning: To reduce the risk of personal injury, do not drop the lamp module or touch the lamp bulb. The bulb may shatter and cause injury if it is dropped.*

# Appendices

## Specifications

Light Valve	- Single Chip DLP™ Technology
Lamp	- 150W User Replaceable Lamp
Number of Pixels	- 800 pixels(H) X 600 lines(V)
Displayable Color	- 16.7M colors
Projection Lens	- F/2.4 f=22.4mm with Electronic Reduction /Enlargement
Projection Screen Size	- 29.4"~289.7" Diagonal
Projection Distance	- 4.0~39.4 ft (1.2m~12m)
Video Compatibility	- NTSC/NTSC 4.43/PAL/PAL-M/PAL-N/SECAM and HDTV compatible
	- Composite video & S-video capability
H. Frequency	- 15kHz~70kHz horizontal scan
V. Frequency	- 43Hz~85Hz vertical refresh
Power Supply	- Universal AC input 100~240V ; Input Frequency 50/60Hz
Power Consumption	- 210 watts at normal operation
Noise level	- 32dBA
I/O Connectors	- Power: AC power input socket
	- Computer Input: One VGA computer input for VGA/ HDTV/ Component Video
	- Computer Output One VGA computer output
	- Video Input: One Composite video RCA input One S-Video input
	- Remote Output One USB mouse output
Weight	- 4.5 lbs / 2 kgs
Dimensions (W x H x D)	With lens: 10.7 x 8.3 x3.4 inches / 272 x 211 x 86mm
Environmental	- Operating Temperature: 10°C~ 40°C/50°F~104°F Humidity: 80% maximum
	- Storage Temperature:-20°C~60°C/ -4°F~140°F Humidity: 80% maximum
Safety Regulation	- FCC Class B, CE Class B, VCCI-II, UL, cUL, TÜV, CCC, PSE

# Appendices

## Compatibility Modes

Compatibility	Resolution	V-Sync [Hz]	H-Sync [KHz]
VGA	640x350	70	31.5
	640x350	85	37.9
	640x400	85	37.9
	640x480	60	31.5
	640x480	72	37.9
	640x480	75	37.5
	640x480	85	43.3
	720x400	70	31.5
	720x400	85	37.9
	SVGA	800x600	56
800x600		60	37.9
800x600		72	48.1
800x600		75	46.9
800x600		85	53.7
XGA	*1024x768	43.4	35.5
	*1024x768	60	48.4
	*1024x768	70	56.5
	*1024x768	75	60.0
	*1024x768	85	68.7
SXGA	*1280x1024	60	63.98
MAC LC 13"	640x480	66.66	34.98
MAC II 13"	640x480	66.68	35
MAC 16"	832x624	74.55	49.725
MAC 19"	*1024x768	75	60.24
MAC G4	640x480	60	31.35
iMacDV	*1024x768	75	60

\*Compression computer image.