

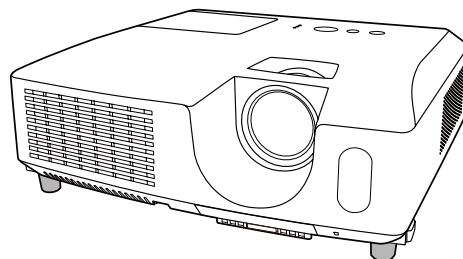

Digital Projector WX36

Operator's Guide



Thank you for purchasing this projector.

⚠ WARNING ▶ Before using this product, please read all manuals for this product. Be sure to read “**Product Warranty and Safety Guide**” first. After reading them, store them in a safe place for future reference.

About this manual

Various symbols are used in this manual. The meanings of these symbols are described below.

⚠ WARNING This symbol indicates information that, if ignored, could possibly result in personal injury or even death due to incorrect handling.

⚠ CAUTION This symbol indicates information that, if ignored, could possibly result in personal injury or physical damage due to incorrect handling.

NOTICE This entry notices of fear of causing trouble.



Please refer to the pages written following this symbol.

NOTE • The information in this manual is subject to change without notice.
• The manufacturer assumes no responsibility for any errors that may appear in this manual.
• The reproduction, transfer or copy of all or any part of this document is not permitted without express written consent.

Trademark acknowledgment

- Mac[®] is a registered trademark of Apple Inc.
- Windows[®], DirectDraw[®] and Direct3D[®] are registered trademarks of Microsoft Corporation in the U.S. and/or other countries.
- VESA and DDC are trademarks of the Video Electronics Standard Association.
- HDMI, the HDMI logo, and High-Definition Multimedia Interface are trademarks or registered trademarks of HDMI Licensing LLC in the United States and other countries.
- Trademark PJLink is a trademark applied for trademark rights in Japan, the United States of America and other countries and areas.
- Blu-ray Disc is a trademark.



All other trademarks are the properties of their respective owners.

Contents

Introduction	3	SETUP menu	40
Features	3	AUTO KEYSTONE, KEYSTONE, AUTO ECO MODE,	
Checking the contents of package	3	ECO MODE, MIRROR, STANDBY MODE,	
Part names	4	MONITOR OUT	
Setting up	7	AUDIO menu	42
Arrangement	7	VOLUME, SPEAKER, AUDIO SOURCE,	
Connecting with your devices	9	HDMI AUDIO, MIC LEVEL, MIC VOLUME	
Connecting to a power supply	14	SCREEN menu	44
Using the security bar and slot	14	LANGUAGE, MENU POSITION, BLANK,	
Remote control	15	START UP, MyScreen, MyScreen Lock,	
Installing the batteries	15	MESSAGE, SOURCE NAME, TEMPLATE, C.C.	
About the remote control signal	15	OPTION menu	50
Changing the frequency of remote control signal	16	AUTO SEARCH, AUTO KEYSTONE,	
Using as a simple PC mouse & keyboard	16	DIRECT POWER ON, AUTO POWER OFF,	
Power on/off	17	USB TYPE B, LAMP TIME, FILTER TIME,	
Turning on the power	17	MY BUTTON, MY SOURCE, SERVICE	
Turning off the power	17	NETWORK menu	60
Operating	18	SETUP, PROJECTOR NAME, MY IMAGE,	
Adjusting the volume	18	AMX D.D., PRESENTATION, INFORMATION,	
Temporarily muting the sound	18	SERVICE	
Selecting an input signal	18	SECURITY menu	67
Searching an input signal	20	SECURITY PASSWORD CHANGE,	
Selecting an aspect ratio	20	MyScreen PASSWORD, PIN LOCK,	
Adjusting the projector's elevator	21	TRANSITION DETECTOR, MY TEXT PASSWORD,	
Adjusting the zoom and focus	21	MY TEXT DISPLAY, MY TEXT WRITING	
Using the automatic adjustment feature	22	Presentation tools	73
Adjusting the position	22	PC-LESS Presentation	73
Correcting the keystone distortions	23	Thumbnail Mode, Full Screen Mode,	
Using the magnify feature	24	Slideshow mode, Playlist	
Temporarily freezing the screen	25	USB Display	82
Temporarily blanking the screen	25	Right-Click menu, Floating menu,	
Using the menu function	26	Options window	
EASY MENU	28	Maintenance	85
ASPECT, AUTO KEYSTONE, KEYSTONE,		Replacing the lamp	85
PICTURE MODE, ECO MODE, MIRROR, RESET,		Cleaning and replacing the air filter	87
FILTER TIME, LANGUAGE, ADVANCED MENU, EXIT		Replacing the internal clock battery	89
PICTURE menu	30	Other care	90
BRIGHTNESS, CONTRAST, GAMMA, COLOR TEMP,		Troubleshooting	91
COLOR, TINT, SHARPNESS, ACTIVE IRIS, MY MEMORY		Related messages	91
IMAGE menu	33	Regarding the indicator lamps	93
ASPECT, OVER SCAN, V POSITION, H POSITION,		Shutting the projector down	94
H PHASE, H SIZE, AUTO ADJUST EXECUTE		Resetting all settings	94
INPUT menu	36	Phenomena that may be easy	
PROGRESSIVE, VIDEO NR, COLOR SPACE,		to be mistaken for machine defects	95
COMPONENT, VIDEO FORMAT, HDMI FORMAT,		Specifications	99
HDMI RANGE, COMPUTER IN,		Technical (English only)	
FRAME LOCK, RESOLUTION		(Please see the end of this book, although only in English.)	

Introduction

Features

The projector provides you with the broad use by the following features.

- ✓ This projector has a variety of I/O ports that supposedly cover for any business scene. The **HDMI** port can support various image equipment which have digital interface to get clearer pictures on a screen.
- ✓ This projector realizes the large projection image, even if in a small space.
- ✓ If you insert a USB storage device, such as a USB memory, into the **USB TYPE A** port and select the port as the input source, you can view images stored in the device.
- ✓ This projector can be controlled and monitored via LAN connection.
- ✓ This projector's network supports the PjLink™ standard.
- ✓ PjLink™ is a unified standard for operating and controlling data projectors. PjLink™ enables central control of projectors manufactured by different vendors and projectors can be operated by a controller. PjLink™ compliant equipment can be managed and controlled at any time and in any place, regardless of manufacturer.
For the command of PjLink™, see “Technical”.
For specifications of PjLink™, see the web site of the Japan Business Machine and Information System Industries Association.

URL: <http://pjlink.jbmia.or.jp/english/> (as of Dec. 2009)

Checking the contents of package

Your projector should come with the items shown there. Require of your dealer immediately if any items are missing.

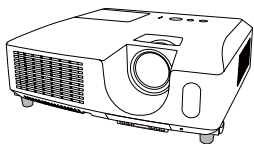

Projector

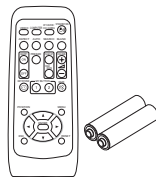

Remote control
(with two AA batteries)

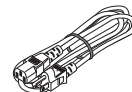

Power cord

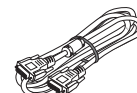

VGA cable

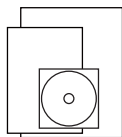

Operator's Guide
Product Warranty and Safety Guide
Quick Start Guide



Lens cover

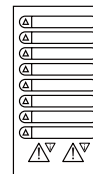

Security Label

NOTE • Keep the original packing materials, for future reshipment. Be sure to use the original packing materials when moving the projector. Use special caution for the lens.

Introduction

Part names

Projector

- (1) Lamp door (📖85)
The lamp unit is inside.
- (2) Focus ring (📖21)
- (3) Zoom ring (📖21)
- (4) Control panel (📖5)
- (5) Elevator buttons (x 2) (📖21)
- (6) Elevator feet (x 2) (📖21)
- (7) Remote sensor (📖15)
- (8) Lens (📖90)
- (9) Intake vents
- (10) Filter cover (📖87)
The air filter and intake vent are inside.
- (11) Battery cover
The internal clock battery is inside.
- (12) Speaker (📖12, 18, 42)
- (13) Exhaust vent
- (14) **AC IN** (AC inlet) (📖14)
- (15) Rear panel (📖5)
- (16) Security bar (📖14)
- (17) Security slot (📖14)
- (18) Shutdown switch (📖94)

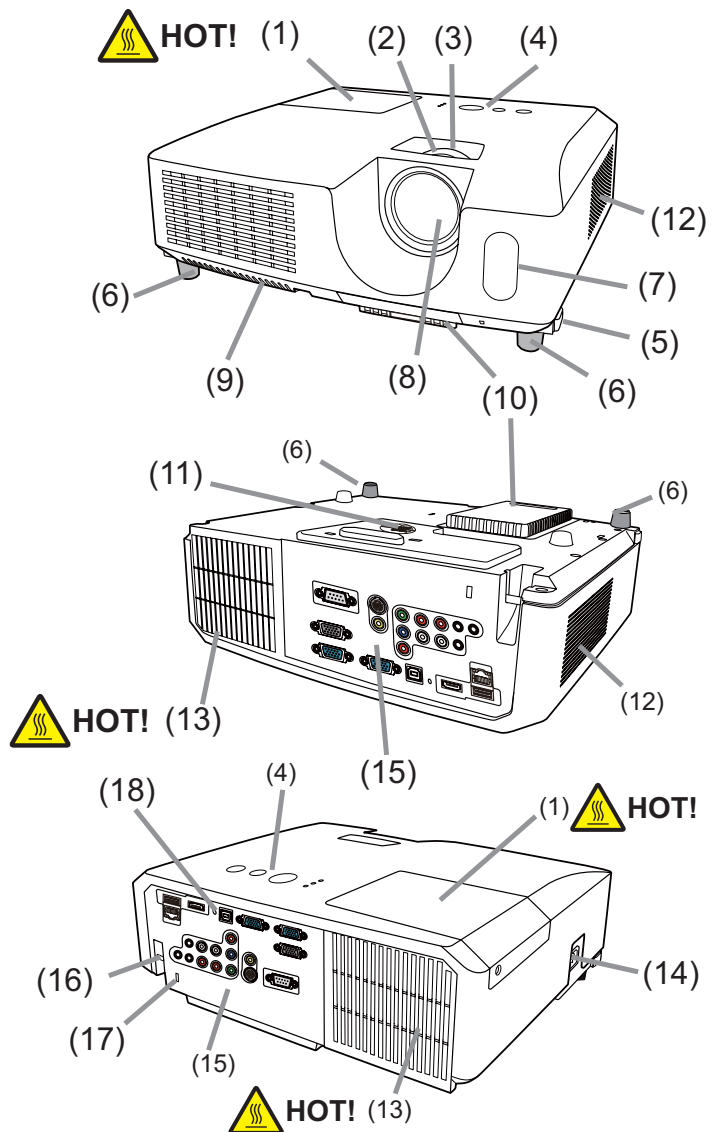

⚠️ WARNING ►HOT! : Do not touch around the lamp door and the exhaust vents during use or just after use, since it is too hot.

► Do not look into the lens or vents while the lamp is on, since the strong light is not good for your eyes.

⚠️ CAUTION ► Maintain normal ventilation to prevent the projector from heating up. Do not cover, block or plug up the vents. Do not place anything that can stick or be sucked to the vents, around the intake vents. Clean the air filter periodically.

► Do not use the security bar and slot to prevent the projector from falling down, since it is not designed for it.

► Do not handle the elevator buttons without holding the projector, since the projector may drop down.

Control panel

- (1) **STANDBY/ON** button (📖17)
- (2) **INPUT** button (📖18)
- (3) **MENU** button (📖26)

It consists of four cursor buttons.

- (4) **POWER** indicator (📖17, 93, 94)
- (5) **TEMP** indicator (📖93, 94)
- (6) **LAMP** indicator (📖93, 94)

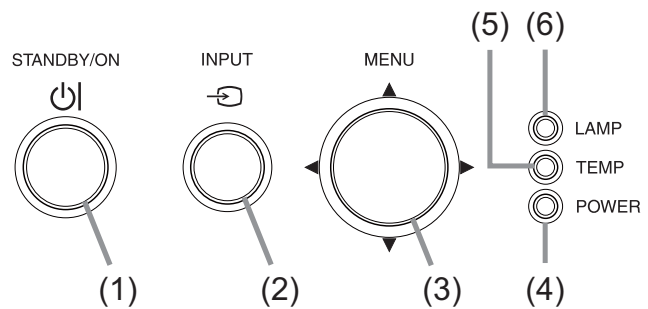

Rear panel (📖9 ~ 13)

- | | |
|----------------------------------|-------------------------------|
| (1) USB TYPE A port | (10) COMPUTER IN1 port |
| (2) LAN port | (11) COMPUTER IN2 port |
| (3) HDMI port | (12) MONITOR OUT port |
| (4) USB TYPE B port | (13) CONTROL port |
| (5) MIC port | (14) VIDEO port |
| (6) AUDIO IN1 port | (15) S-VIDEO port |
| (7) AUDIO IN2 port | (16) Cr/Pr,Cb/Pb,Y |
| (8) AUDIO IN3(L,R) ports | (Component) ports |
| (9) AUDIO OUT (L,R) ports | |

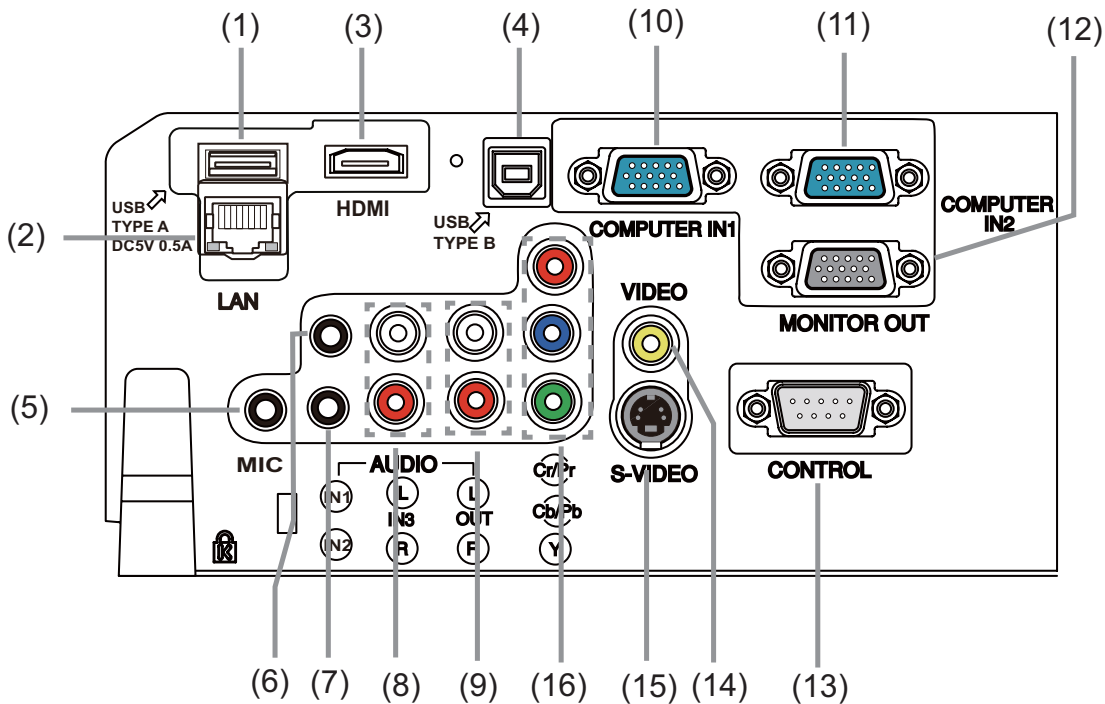

CAUTION ▶ Use the shutdown switch only when the projector is not turned off by normal procedure, since pushing this switch stops operation of the projector without cooling it down.

Introduction

Remote control

- (1) **VIDEO** button (📖 19)
- (2) **COMPUTER** button (📖 19)
- (3) **SEARCH** button (📖 20)
- (4) **STANDBY/ON** button (📖 17)
- (5) **ASPECT** button (📖 20)
- (6) **AUTO** button (📖 22)
- (7) **BLANK** button (📖 25)
- (8) **MAGNIFY - ON** button (📖 24)
- (9) **MAGNIFY - OFF** button (📖 24)
- (10) **MY SOURCE/DOC.CAMERA** button (📖 19, 54)
- (11) **VOLUME -** button (📖 18)
- (12) **PAGE UP** button (📖 16)
- (13) **PAGE DOWN** button (📖 16)
- (14) **VOLUME +** button (📖 18)
- (15) **MUTE** button (📖 18)
- (16) **FREEZE** button (📖 25)
- (17) **MY BUTTON - 1** button (📖 53)
- (18) **MY BUTTON - 2** button (📖 53)
- (19) **KEystone** button (📖 23)
- (20) **POSITION** button (📖 22, 27)
- (21) **MENU** button (📖 26, 27)
- (22) **▲/▼/◀/▶** cursor buttons (📖 26, 27)
- (23) **ENTER** button (📖 26, 27)
- (24) **ESC** button (📖 27)
- (25) **RESET** button (📖 27)
- (26) **Battery cover** (📖 15)

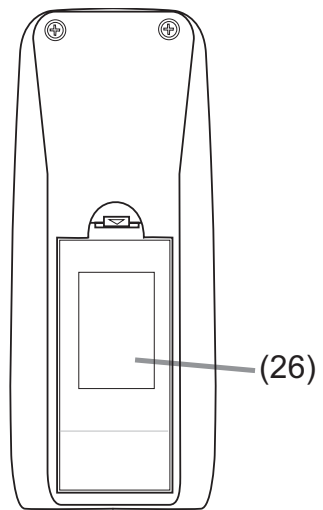
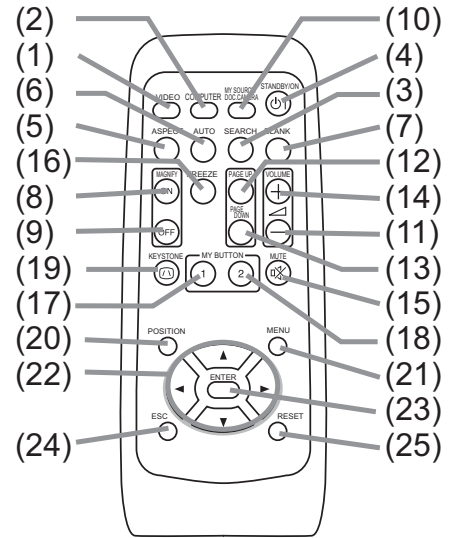

Back of the remote control

Setting up

Install the projector according to the environment and manner the projector will be used in.

Arrangement

Refer to the illustrations and tables below to determine screen size and projection distance. The values shown in the table are calculated for a full size screen: 1280 x 800

Ⓜ × Ⓥ Screen size

ⓐ : Projection distance
(±10%, from the projector's end)

ⓑ , ⓒ : Screen height (±10%)

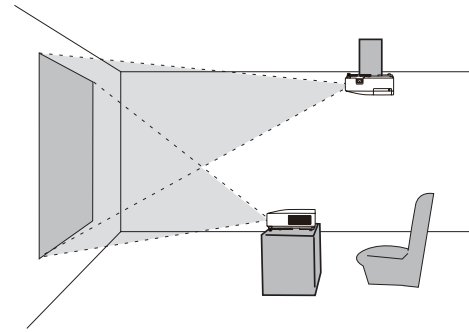

On a horizontal surface

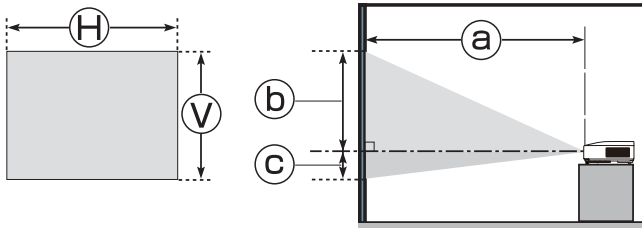

Suspended from the ceiling

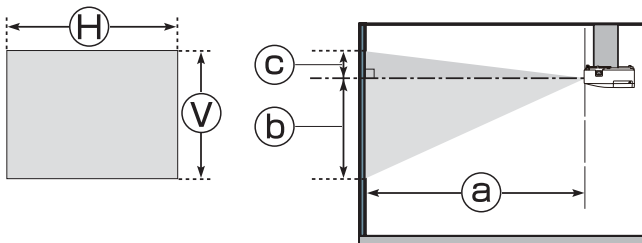

- Keep a space of 30 cm or more between the sides of the projector and other objects such as walls.
- For the case of installation in a special state such as ceiling mount, the specified mounting accessories and service may be required. Before installing the projector, consult your dealer about your installation.

16:10 screen

Type (inch)	Screen size		Projection distance				Screen height			
	Ⓜ	Ⓥ	ⓐ (min.)		ⓐ (max.)		ⓑ		ⓒ	
	[m]	[m]	[m]	[inch]	[m]	[inch]	[cm]	[inch]	[cm]	[inch]
30	0.6	0.4	0.9	35	1.1	43	40	16	1	0
40	0.9	0.5	1.2	48	1.5	58	53	21	1	0
50	1.1	0.7	1.5	61	1.9	74	66	26	1	1
60	1.3	0.8	1.9	73	2.3	89	79	31	2	1
70	1.5	0.9	2.2	86	2.7	105	92	36	2	1
80	1.7	1.1	2.5	99	3.1	121	106	42	2	1
90	1.9	1.2	2.8	112	3.5	136	119	47	2	1
100	2.2	1.3	3.2	125	3.9	152	132	52	3	1
120	2.6	1.6	3.8	151	4.6	183	158	62	3	1
150	3.2	2.0	4.8	190	5.8	229	198	78	4	2
200	4.3	2.7	6.5	254	7.8	307	264	104	5	2
250	5.4	3.4	8.1	319	9.8	385	330	130	7	3
300	6.5	4.0	9.7	383	11.8	463	396	156	8	3

4:3 screen

Type (inch)	Screen size		Projection distance				Screen height			
	Ⓜ	Ⓥ	ⓐ (min.)		ⓐ (max.)		ⓑ		ⓒ	
	[m]	[m]	[m]	[inch]	[m]	[inch]	[cm]	[inch]	[cm]	[inch]
30	0.6	0.5	1.0	40	1.2	49	45	18	1	0
40	0.8	0.6	1.4	54	1.7	67	60	24	1	0
50	1.0	0.8	1.8	69	2.1	84	75	29	2	1
60	1.2	0.9	2.1	84	2.6	102	90	35	2	1
70	1.4	1.1	2.5	98	3.0	119	105	41	2	1
80	1.6	1.2	2.9	113	3.5	137	119	47	2	1
90	1.8	1.4	3.2	128	3.9	155	134	53	3	1
100	2.0	1.5	3.6	142	4.4	172	149	59	3	1
120	2.4	1.8	4.4	171	5.3	207	179	71	4	1
150	3.0	2.3	5.5	215	6.6	260	224	88	5	2
200	4.1	3.0	7.3	288	8.8	348	299	118	6	2
250	5.1	3.8	9.2	361	11.1	436	373	147	8	3
300	6.1	4.6	11.0	434	13.3	524	448	176	9	4

(continued on next page)

Setting up

Arrangement (continued)

⚠ WARNING ► Place the projector in a stable horizontal position. If the projector falls or is knocked over, it could cause injury and/or damage to the projector. Using a damaged projector could then result in fire and/or electric shock.

- Do not place the projector on an unstable, slanted or vibrational surface such as a wobbly or inclined stand.
- Do not place the projector on its side, front or rear position.
- Consult with your dealer before a special installation such as suspending from a ceiling or somewhere else.

► Place the projector in a cool place, and ensure that there is sufficient ventilation. The high temperature of the projector could cause fire, burns and/or malfunction of the projector.

- Do not stop-up, block or otherwise cover the projector's vents.
- Keep a space of 30 cm or more between the sides of the projector and other objects such as walls.
- Do not place or attach anything that would block the lens or vent holes.
- Do not place the projector on metallic thing or anything weak in heat.
- Do not place the projector on carpet, cushions or bedding.
- Do not place the projector in direct sunlight or near hot objects such as heaters.
- Do not place anything near the projector lens or vents, or on top of the projector.

- Do not place anything that may be sucked into or stick to the vents on the bottom of the projector. This projector has some intake vents also on the bottom.

► Do not place the projector anywhere where it may get wet. Getting the projector wet or inserting liquid into the projector could cause fire, electric shock and/or malfunction of the projector.

- Do not place the projector in a bathroom or the outdoors.
- Do not place anything containing liquid near the projector.

► Use only the mounting accessories the manufacturer specified, and leave installing and removing the projector with the mounting accessories to the service personnel.

- Read and keep the user's manual of the mounting accessories used.

⚠ CAUTION ► Avoid placing the projector in smoky, humid or dusty place. Placing the projector in such places could cause fire, electric shock and/or malfunction of the projector.

- Do not place the projector near humidifiers, smoking spaces or a kitchen. Also do not use an ultrasonic humidifier near the projector. Otherwise chlorine and minerals contained in tap water are atomized and could be deposited in the projector causing image degradation or other problems.

► Position the projector to prevent light from directly hitting the projector's remote sensor.

► Do not place the product in a place where radio interference may be caused.

► Do not place this product in a magnetic field.

Connecting with your devices

Before connecting the projector to a device, consult the manual of the device to confirm that the device is suitable for connecting with this projector and prepare the required accessories, such as a cable in accord with the signal of the device. Consult your dealer when the required accessory did not come with the product or the accessory is damaged.

After making sure that the device and projector are turned off, connect them following the instructions below.

⚠ WARNING ► Use only the appropriate accessories. Otherwise it could cause a fire or damage to the device and the projector.

- Use only the accessories specified or recommended by the projector's manufacturer. Consult your dealer when the required accessory did not come with the product or the accessory is damaged. It may be regulated under some standard.
- For a cable with a core at only one end, connect the end with the core to the projector. That may be required by EMI regulations.
- Neither disassemble nor modify the projector and the accessories.
- Do not use the damaged accessory. Be careful not to damage the accessories. Route a cable so that it is neither stepped on nor pinched out.

CAUTION ► Do not turn on or off the projector while connected to a device in operation, unless that is directed in the manual of the device. Otherwise it may cause malfunction in the device or projector.

- Be careful not to mistakenly connect a connector to a wrong port. Otherwise it may cause malfunction in the device or projector.
- When connecting a connector to a port, make sure that the shape of the connector fits the port.
- Tighten the screws to connect a connector equipped with screws to a port.
- Use the cables with straight plugs, not L-shaped ones, as the input ports of the projector are recessed.

About Plug-and-Play capability

- Plug-and-Play is a system composed of a computer, its operating system and peripheral equipment (i.e. display devices). This projector is VESA DDC 2B compatible. Plug-and-Play can be used by connecting this projector to a computer that is VESA DDC (display data channel) compatible.
- Take advantage of this feature by connecting a computer cable to the **COMPUTER IN1** port (DDC 2B compatible). Plug-and-Play may not work properly if any other type of connection is attempted.
- Please use the standard drivers in your computer as this projector is a Plug-and-Play monitor.

(continued on next page)

Setting up

Connecting with your devices (continued)

- When AUTO is selected for the **COMPUTER IN1** or **COMPUTER IN2** port in COMPUTER IN of the INPUT menu, that port will accept component video signals (📖38).
- When the **USB TYPE B** port and the computer's type A USB port are connected, you can use the **USB TYPE B** port as a picture input port from the computer, or use the remote control as a simple mouse and keyboard of the computer. (📖16, 51).

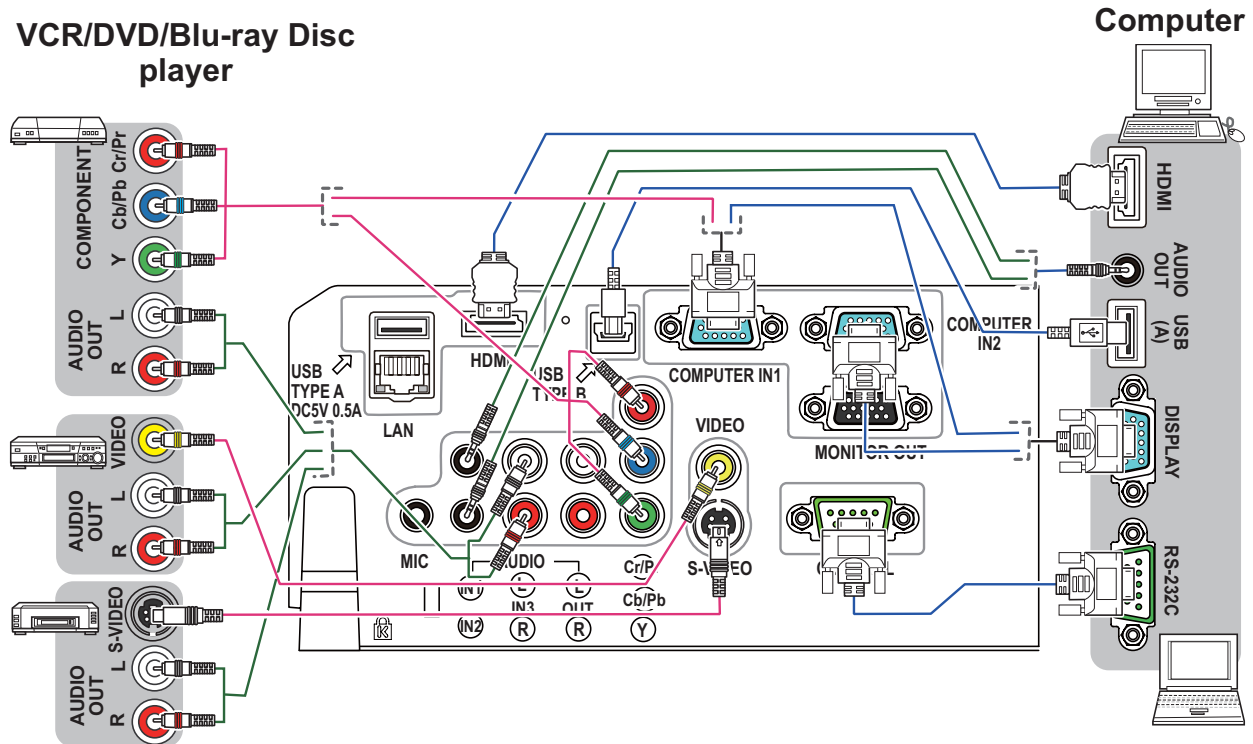

(continued on next page)

Connecting with your devices (continued)

- NOTE** • Before connecting the projector to a computer, consult the computer's manual and check the compatibility of the signal level, the synchronization methods and the display resolution output to the projector.
- Some signal may need an adapter to input this projector.
 - Some computers have multiple screen display modes that may include some signals which are not supported by this projector.
 - Although the projector can display signals with resolution up to UXGA (1600X1200), the signal will be converted to the projector's panel resolution before being displayed. The best display performance will be achieved if the resolutions of the input signal and the projector panel are identical.
 - If you connect this projector and a notebook computer, you need output the display to an external monitor, or output simultaneously to the internal display and an external monitor. Consult the computer's manual for the setting.
 - Depending on the input signal, the automatic adjustment function of this projector may take some time and not function correctly.
 - Note that a composite sync signal or sync-on-green signal may confuse the automatic adjustment function of this projector ( 38).
 - If the automatic adjustment function does not work correctly, you may not see the dialog to set the display resolution. In such a case, use an external display device. You may be able to see the dialog and set an appropriate display resolution.

(continued on next page)

Setting up

Connecting with your devices (continued)

- If you insert a USB storage device, such as a USB memory, into the **USB TYPE A** port and select the port as the input source, you can view images stored in the device (📖73).
- You can connect a dynamic microphone to the **MIC** port with a 3.5 mm mini-plug. In that case, the built-in speaker outputs the sound from the microphone, even while the sound from the projector is output. You can input line level signal to the **MIC** port from equipment such as wireless microphone. Select HIGH in the MIC LEVEL item of the AUDIO menu when you input line level audio signal to the **MIC** port. In the normal mode, the volume of the microphone can be adjusted separately from the volume of the projector using the menu. (📖43)
In the standby mode, the volume of the microphone is adjustable with the **VOLUME +/-** buttons on the remote control, in synchronization with the volume of the projector. (📖18)
Even when the sound of projector is set to mute mode by the AUDIO SOURCE function (📖42), the volume of the microphone is adjustable.
In both modes (standby or normal), the **MUTE** button on the remote control works on the sounds of the microphone and the projector. (📖18)

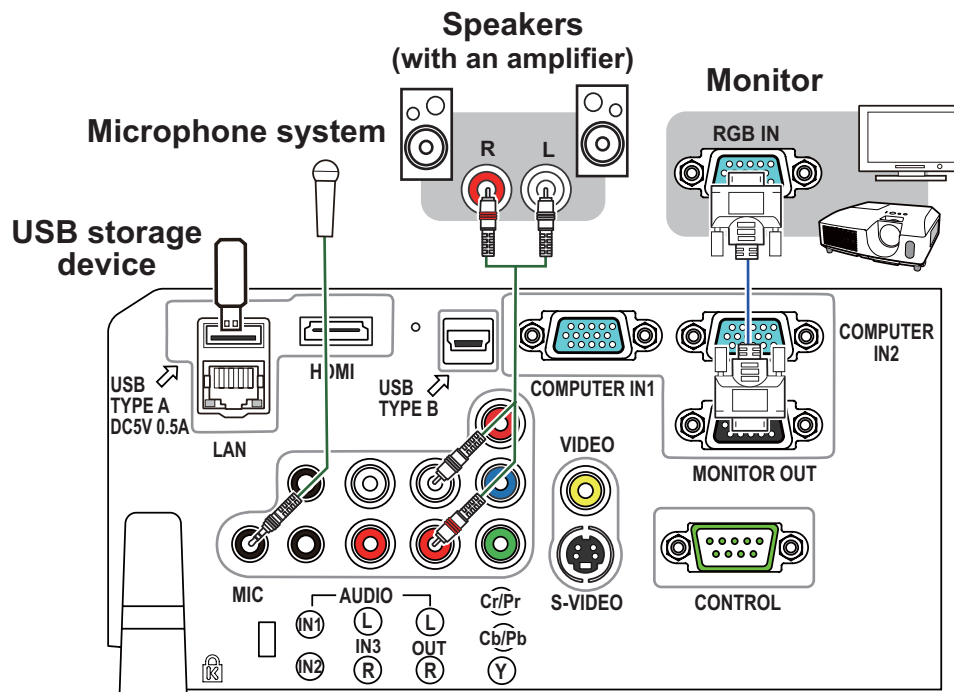

⚠ CAUTION ▶ Before removing the USB storage device from the port of the projector, be sure to use the REMOVE USB function on the thumbnail screen to secure your data (📖76).

NOTE • If a loud feedback noise is produced from the speaker, move the microphone away from the speaker.
• This projector doesn't support plug-in power for the microphone.

Connecting with your devices (continued)

To use network functions of the projector, connect the **LAN** port with the computer's LAN port, or with an access point that is connected to the computer with wireless LAN, using a LAN cable. To use NETWORK BRIDGE function, also connect the **CONTROL** port and an RS-232C port of the external device to communicate as a network terminal. See the **Network Guide** for details of the network functions.

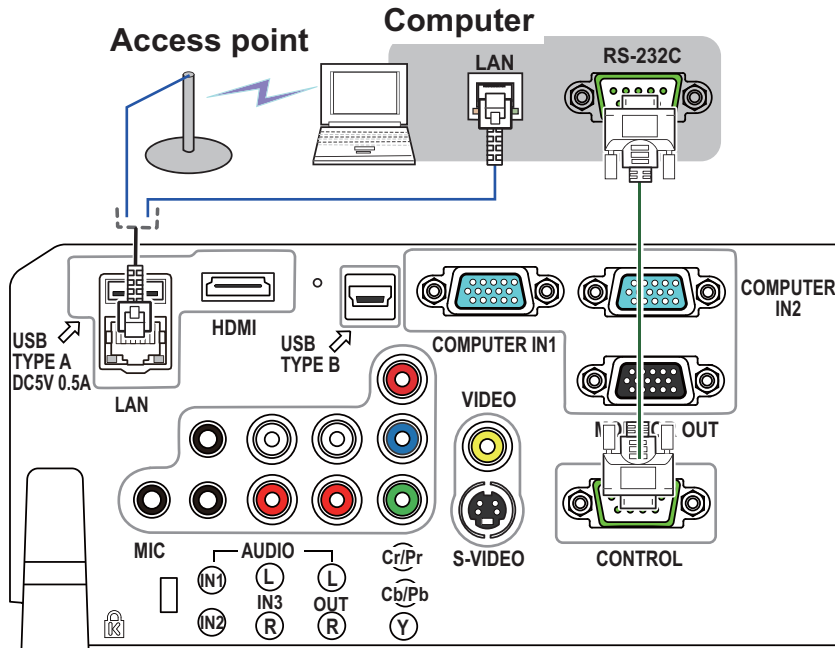

⚠ CAUTION ▶ Before connecting the projector to a network system be sure to obtain the consent of the administrator of the network ([60](#)).
▶ Do not connect the **LAN** port to any network that might have the excessive voltage.

NOTE • If an oversized USB storage device blocks the **LAN** port, use a USB extension cable to connect the USB storage device.

Setting up

Connecting to a power supply

1. Put the connector of the power cord into the **AC IN** (AC inlet) of the projector.
2. Firmly plug the power cord's plug into the outlet. In a couple of seconds after the power supply connection, the **POWER** indicator will light up in steady orange.

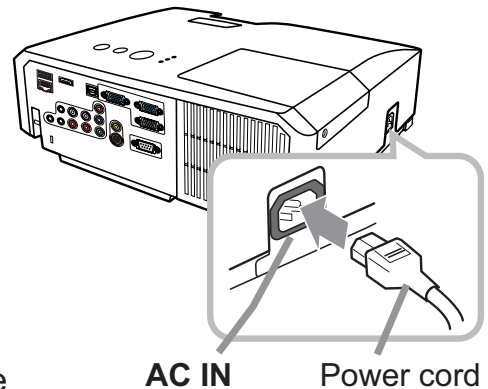

Please remember that when the DIRECT POWER ON function activated (📖 50), the connection of the power supply make the projector turn on.

⚠ WARNING ▶ Please use extra caution when connecting the power cord, as incorrect or faulty connections may result in fire and/or electrical shock.

- Only use the power cord that came with the projector. If it is damaged, consult your dealer to get a new one.
- Only plug the power cord into an outlet whose voltage is matched to the power cord. The power outlet should be close to the projector and easily accessible. Remove the power cord for complete separation.
- Never modify the power cord.

Using the security bar and slot

A commercial anti-theft chain or wire up to 10 mm in diameter can be attached to the security bar on the projector. Also this product has the security slot for the Kensington lock. For details, see the manual of the security tool.

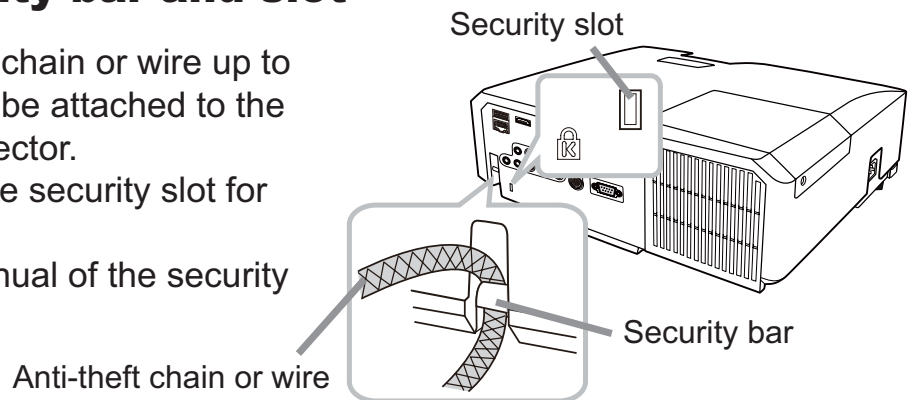

⚠ CAUTION ▶ Do not use the security bar and slot to prevent the projector from falling down, since it is not designed for it.

▶ Do not place anti-theft chain or wire near the exhaust vents. It may become too hot.

NOTE • The security bar and slot is not comprehensive theft prevention measures. It is intended to be used as supplemental theft prevention measure.

Remote control

Installing the batteries

Please insert the batteries into the remote control before using it. If the remote control starts to malfunction, try to replace the batteries. If you will not use the remote control for long period, remove the batteries from the remote control and store them in a safe place.

1. Holding the hook part of the battery cover, remove it.
2. Align and insert the two AA batteries (**HITACHI MAXELL, Part No.LR6 or R6P**) according to their plus and minus terminals as indicated in the remote control.
3. Replace the battery cover in the direction of the arrow and snap it back into place.

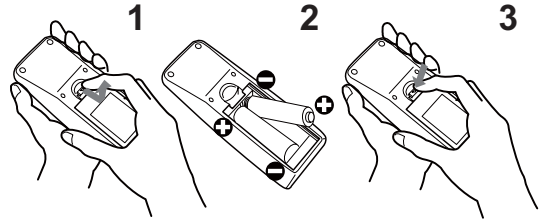

⚠ WARNING ► Always handle the batteries with care and use them only as directed. Improper use may result in battery explosion, cracking or leakage, which could result in fire, injury and/or pollution of the surrounding environment.

- Be sure to use only the batteries specified. Do not use batteries of different types at the same time. Do not mix a new battery with used one.
- Make sure the plus and minus terminals are correctly aligned when loading a battery.
- Keep a battery away from children and pets.
- Do not recharge, short circuit, solder or disassemble a battery.
- Do not place a battery in a fire or water. Keep batteries in a dark, cool and dry place.
- If you observe battery leakage, wipe out the leakage and then replace a battery. If the leakage adheres to your body or clothes, rinse well with water immediately.
- Obey the local laws on disposing the battery.

About the remote control signal

The remote control works with the projector's remote sensor. This projector has a remote sensor on the front. The sensor senses the signal within the following range when the sensor is active:

60 degrees (30 degrees to the left and right of the sensor)
within 3 meters about.

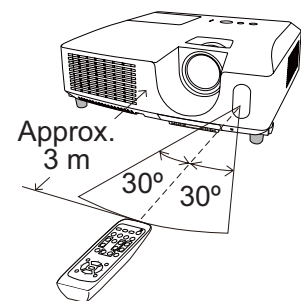

NOTE • The remote control signal reflected in the screen or the like may be available. If it is difficult to send the signal to the sensor directly, attempt to make the signal reflect.

- The remote control uses infrared light to send signals to the projector (Class 1 LED), so be sure to use the remote control in an area free from obstacles that could block the remote control's signal to the projector.
- The remote control may not work correctly if strong light (such as direct sun light) or light from an extremely close range (such as from an inverter fluorescent lamp) shines on the remote sensor of the projector. Adjust the position of projector avoiding those lights.

Remote control

Changing the frequency of remote control signal

The accessory remote control has the two choices on signal frequency Mode 1:NORMAL and Mode 2:HIGH. If the remote control does not function properly, attempt to change the signal frequency. In order to set the Mode, please keep pressing the combination of two buttons listed below simultaneously for about 3 seconds.

- (1) Set to Mode 1:NORMAL... **VOLUME -** and **RESET** buttons
- (2) Set to Mode 2:HIGH... **MAGNIFY OFF** and **ESC** buttons

Please remember that the REMOTE FREQ. in the SERVICE item of the OPTION menu (📖56) of the projector to be controlled should be set to the same mode as the remote control.

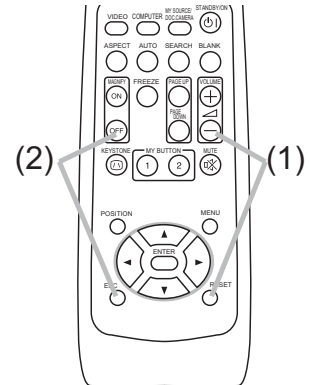

Using as a simple PC mouse & keyboard

The accessory remote control works as a simple mouse and keyboard of the computer, when the projector's **USB TYPE B** port and the computer's type A USB port are connected and MOUSE is selected for the USB TYPE B item in the OPTION menu (📖51).

- (1) **PAGE UP key:** Press **PAGE UP** button.
- (2) **PAGE DOWN key:** Press **PAGE DOWN** button.
- (3) **Mouse left button:** Press **ENTER** button.
- (4) **Move pointer:** Use the cursor buttons **▲**, **▼**, **◀** and **▶**.
- (5) **ESC key:** Press **ESC** button.
- (6) **Mouse right button:** Press **RESET** button.

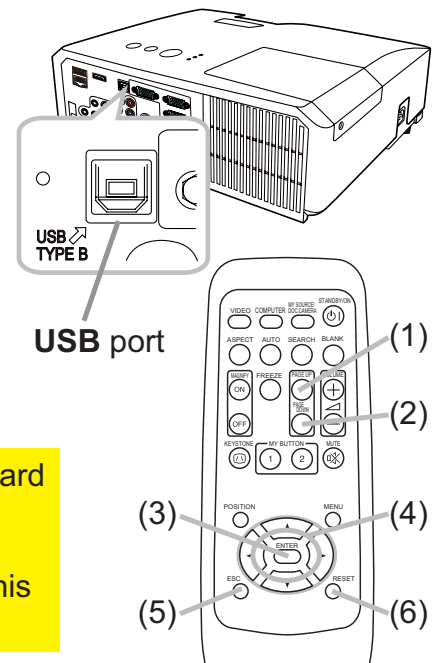

⚠ NOTICE ▶ Improper use of the simple mouse & keyboard function could damage your equipment. While using this function, please connect this product only to a computer. Be sure to check your computer's manuals before connecting this product to the computer.

NOTE When the simple mouse & keyboard function of this product does not work correctly, please check the following.

- When a USB cable connects this projector with a computer having a built-in pointing device (e.g. track ball) like a laptop PC, open BIOS setup menu, then select the external mouse and disable the built-in pointing device, because the built-in pointing device may have priority to this function.
- Windows 95 OSR 2.1 or higher is required for this function. And also this function may not work depending on the computer's configurations and mouse drivers. This function can work with the computer which can operate general USB mouse or keyboard.
- You cannot do things like press two buttons at once (for instance, pressing two buttons at the same time to move the mouse pointer diagonally).
- This function is activated only when the projector is working properly. This function is not available in any of the following cases:
 - While the lamp is warming up. (The **POWER** indicator blinks in green.)
 - When either **USB TYPE A** or **USB TYPE B** port is selected.
 - While displaying **BLANK** (📖25), **TEMPLATE** (📖48) or **MY IMAGE** (📖63) screen.
 - When any menu is displayed on the screen.
 - While using the cursor buttons to operate the sound or screen functions such as adjusting the sound volume, correcting the keystone, correcting the picture position and magnifying the screen.

Power on/off

Turning on the power

1. Make sure that the power cord is firmly and correctly connected to the projector and the outlet.
2. Make sure that the **POWER** indicator is steady orange (📖93). Then remove the lens cover.
3. Press **STANDBY/ON** button on the projector or the remote control.
The projection lamp will light up and **POWER** indicator will begin blinking in green. When the power is completely on, the indicator will stop blinking and light in steady green (📖93).

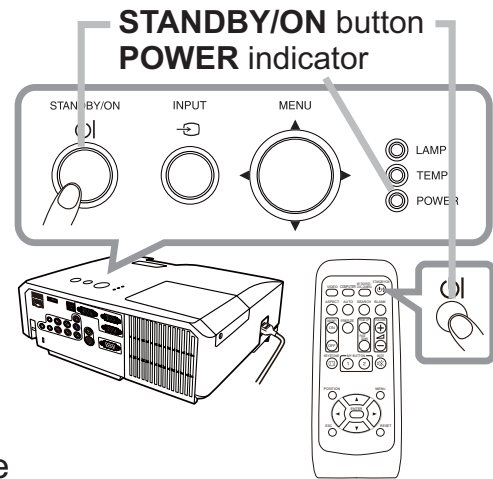

To display the picture, select an input signal according to the section “Selecting an input signal” (📖18).

Turning off the power

1. Press the **STANDBY/ON** button on the projector or the remote control.
The message “Power off?” will appear on the screen for about 5 seconds.
2. Press the **STANDBY/ON** button again while the message appears.
The projector lamp will go off, and the **POWER** indicator will begin blinking in orange. Then **POWER** indicator will stop blinking and light in steady orange when the lamp cooling is complete (📖93).
3. Attach the lens cover, after the **POWER** indicator turns in steady orange.

Do not turn the projector on for about 10 minutes or more after turning it off. Also, do not turn the projector off shortly after turning it on. Such operations might cause the lamp to malfunction or shorten the lifetime of some parts including the lamp.

⚠ WARNING ▶ A strong light is emitted when the projector’s power is on. Do not look into the lens of the projector or look inside of the projector through any of the projector’s openings.
▶ Do not touch around the lamp door and the exhaust vents during use or just after use, since it is too hot.

NOTE • Turn the power on/off in right order. Please power on the projector prior to the connected devices.
• This projector has the function that can make the projector automatically turn on/off. Please refer to the DIRECT POWER ON (📖50) and AUTO POWER OFF (📖51) items of the OPTION menu.
• Use the shutdown switch (📖94) only when the projector is not turned off by normal procedure.

Selecting an input signal (continued)

1. Press **COMPUTER** button on the remote control.
 - Each time you press the button, the projector switches its input port from the current port as below.



- While ON is selected for AUTO SEARCH item in OPTION menu, the projector will keep checking every port sequentially till an input signal is detected (50). If **COMPUTER** button is pressed when **VIDEO**, **S-VIDEO**, **COMPONENT** or **HDMI** port is selected, the projector will check **COMPUTER IN1** port first.
- It may take several seconds to project the images from the **USB TYPE B** port.

COMPUTER button

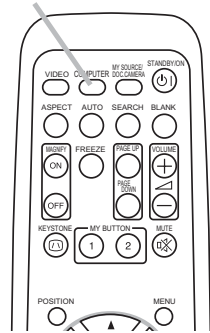

1. Press **VIDEO** button on the remote control.
 - Each time you press the button, the projector switches its input port from the current port as below.



- While ON is selected for AUTO SEARCH item in OPTION menu, the projector will keep checking every port sequentially till an input signal is detected (50). If **VIDEO** button is pressed when **COMPUTER IN1** or **COMPUTER IN2** port is selected, the projector will check **HDMI** port first.

VIDEO button

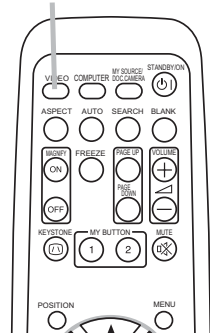

1. Press the **MY SOURCE / DOC. CAMERA** button on the remote control. The input signal will be changed into the signal you set as MY SOURCE (54).

- This function also can use for document camera. Select the input port that connected the document camera.

MY SOURCE / DOC. CAMERA button

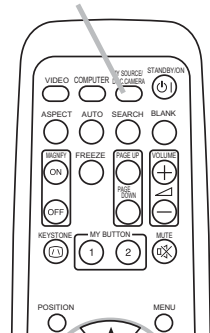

Adjusting the projector's elevator

When the place to put the projector is slightly uneven to the left or right, use the elevator feet to place the projector horizontally.

Using the feet can also tilt the projector in order to project at a suitable angle to the screen, elevating the front side of the projector within 14 degrees.

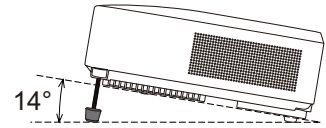

This projector has 2 elevator feet and 2 elevator buttons. An elevator foot is adjustable while pushing the elevator button on the same side as it.

1. Holding the projector, push the elevator buttons to loose the elevator feet.
2. Position the front side of the projector to the desired height.
3. Release the elevator buttons in order to lock the elevator feet.
4. After making sure that the elevator feet are locked, put the projector down gently.
5. If necessary, the elevator feet can be manually twisted to make more precise adjustments. Hold the projector when twisting the feet.

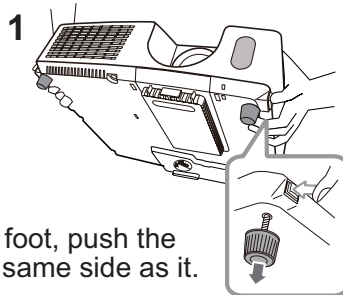

To loose an elevator foot, push the elevator button on the same side as it.

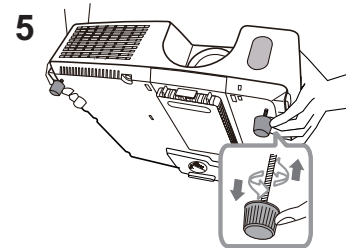

To finely adjust, twist the foot.

⚠ CAUTION ► Do not handle the elevator buttons without holding the projector, since the projector may drop down.
 ► Do not tilt the projector other than elevating its front within 14 degrees using the adjuster feet. A tilt of the projector exceeding the restriction could cause malfunction or shortening the lifetime of consumables, or the projector itself.

Adjusting the zoom and focus

1. Use the zoom ring to adjust the screen size.
2. Use the focus ring to focus the picture.

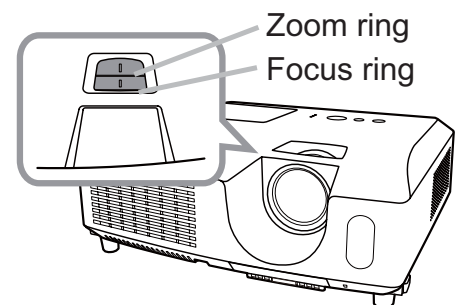

Using the automatic adjustment feature

1. Press **AUTO** button on the remote control.

- **For a computer signal**

The vertical position, the horizontal position and the horizontal phase will be automatically adjusted.

Make sure that the application window is set to its maximum size prior to attempting to use this feature. A dark picture may still be incorrectly adjusted. Use a bright picture when adjusting.

- **For a video signal and s-video signal**

The video format best suited for the respective input signal will be selected automatically. This function is available only when the AUTO is selected for the VIDEO FORMAT item in the INPUT menu (📖37). The vertical position and horizontal position will be automatically set to the default.

- **For a component video signal**

The vertical position and horizontal position will be automatically set to the default. The horizontal phase will be automatically adjusted.

- The automatic adjustment operation requires approx. 10 seconds. Also please note that it may not function correctly with some input.
- When this function is performed for a video signal, a certain extra such as a line may appear outside a picture.
- When this function is performed for a computer signal, a black frame may be displayed on the edge of the screen, depending on the PC model.
- The items adjusted by this function may vary when the FINE or DISABLE is selected for the AUTO ADJUST item of the SERVICE item in the OPTION menu (📖55).

AUTO button

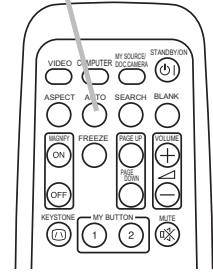

Adjusting the position

1. Press **POSITION** button on the remote control when no menu is indicated.

The "POSITION" indication will appear on the screen.

2. Use the ▲/▼/◀/▶ cursor buttons to adjust the picture position.

When you want to reset the operation, press **RESET** button on the remote control during the operation. To complete this operation, press **POSITION** button again. Even if you do not do anything, the dialog will automatically disappear after a few seconds.

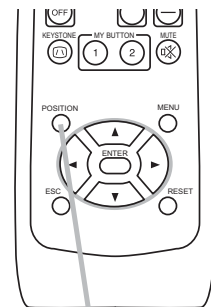

POSITION button

- When this function is performed on a video signal or an s-video signal, some image such as an extra-line may appear at outside of the picture.
- When this function is performed on a video signal or s-video signal, the range of this adjustment depends on OVER SCAN in IMAGE menu (📖33) setting. It is not possible to adjust when OVER SCAN is set to 10.
- If **POSITION** button is pressed when a menu is indicated on screen, the displayed picture does not move its position but the menu does.
- This function is unavailable for a signal from the **LAN**, **USB TYPE A**, **USB TYPE B** or **HDMI** port.

Correcting the keystone distortions

KEYSTONE button

1. Press **KEYSTONE** button on the remote control. A dialog will appear on the screen to aid you in correcting the distortion.

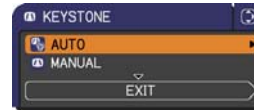

2. Use the ▲/▼ cursor buttons to select **AUTO** or **MANUAL** operation, and press the ► button to perform the following.
 - (1) **AUTO** executes automatic vertical keystone correction.
 - (2) **MANUAL** displays a dialog for keystone correction. Use the ◀/▶ buttons for adjustment.

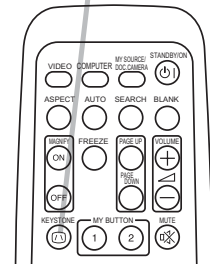

To close the dialog and complete this operation, press **KEYSTONE** button again. Even if you do not do anything, the dialog will automatically disappear after a few seconds.

- The adjustable range of this function will vary among inputs. For some input, this function may not work well.
- When V:INVERT or H&V:INVERT is selected to the MIRROR item in the SETUP menu, if the projector screen is inclined or angled downward, automatic vertical keystone correction may not work correctly.
- When the zoom adjustment is set to the TELE (telephoto focus), this function may be excessive. This function should be used when the zoom adjustment is set to the full WIDE (wide-angle focus) whenever possible.
- When the projector is placed on the level (about $\pm 4^\circ$), the automatic keystone distortion correction may not work.
- When the projector is inclined to near ± 30 degree or over, this function may not work well.
- This function will be unavailable when Transition Detector is on (📖70).

Using the magnify feature

1. Press the **MAGNIFY ON** button on the remote control. The picture will be magnified, and the MAGNIFY dialog will appear on the screen. When the **MAGNIFY ON** button is pressed for the first time after the projector is turned on, the picture will be zoomed by 1.5 times. On the dialog, triangle marks to show each direction will be displayed.
2. While the triangles are displayed on the dialog, use the ▲/▼/◀/▶ cursor buttons to shift the magnifying area.
3. A magnifying glass icon will be displayed on the dialog when the **MAGNIFY ON** button is pressed while the dialog with the triangles is displayed.
4. While the magnifying glass icon is displayed on the dialog, use the ▲/▼ cursor buttons to adjust the magnification ratio. The magnification ratio will be adjusted with fine steps. And changes in the ratio in single steps are subtle so they may be hard to recognize.
5. Press the **MAGNIFY OFF** button on the remote control to exit magnification.
 - The MAGNIFY dialog will automatically disappear in several seconds with no operation. The dialog will appear again if the **MAGNIFY ON** button is pressed when the dialog has automatically disappeared.
 - While the MAGNIFY dialog is displayed, press the **MAGNIFY ON** button to switch the dialog between magnifying area shifting (with the triangles) and magnification ratio adjustment (with the magnifying glass icon).
 - The magnification is automatically disabled when the displaying signal or its display condition is changed.
 - While the magnification is active, the keystone distortion condition may vary. It will be restored when the magnification is disabled.
 - Some horizontal stripes might be visible on the image while magnification is active.
 - This function is not available in the following cases:
 - The **USB TYPE A** port is selected as the input source.
 - A sync signal in the range not supported is input.
 - There is no input signal.

MAGNIFY ON/OFF button

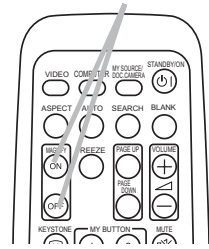

Temporarily freezing the screen

1. Press the **FREEZE** button on the remote control.
 - The “FREEZE” indication will appear on the screen (however, the indication will not appear when the OFF is selected for the MESSAGE item in the SCREEN menu (📖46)), and the projector will go into the FREEZE mode, which the picture is frozen.

To exit the FREEZE mode and restore the screen to normal, press the **FREEZE** button again.

FREEZE button

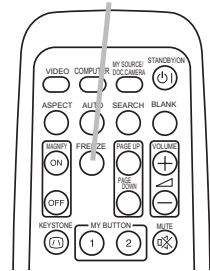

- The projector automatically exits from the FREEZE mode when some control buttons are pressed.
- If the projector continues projecting a still image for a long time, the LCD panel might possibly be burned in. Do not leave the projector in the FREEZE mode for too long.
- Images might appear degraded when this function is operated, but it is not a malfunction.

Temporarily blanking the screen

1. Press **BLANK** button on the remote control.
 - The BLANK screen will be displayed instead of the screen of input signal. Please refer to BLANK item in SCREEN menu (📖44).

To exit from the BLANK screen and return to the input signal screen, press **BLANK** button again.

BLANK button

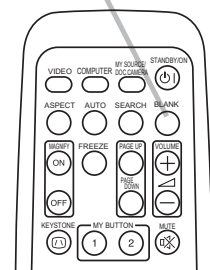

- The projector automatically exits from the BLANK mode when some control buttons are pressed.

⚠ CAUTION ► If you wish to have a blank screen while the projector's lamp is on, use one of methods below.

- Use the supplied lens cover.
- Use the BLANK function above.

Taking any other action may cause the damage on the projector.

NOTE • The sound is not connected with the BLANK screen function. If necessary, set the volume or mute first. To display the BLANK screen and mute the sound at one time, use AV MUTE function (📖53).

Operating

Using the menu function

This projector has the following menus:

PICTURE, IMAGE, INPUT, SETUP, AUDIO, SCREEN, OPTION, NETWORK, SECURITY and EASY MENU.

EASY MENU consists of functions often used, and the other menus are classified into each purpose and brought together as the ADVANCED MENU.

Each of these menus is operated using the same methods. While the projector is displaying any menu, the **MENU** button on the projector works as the cursor buttons. The basic operations of these menus are as follows.

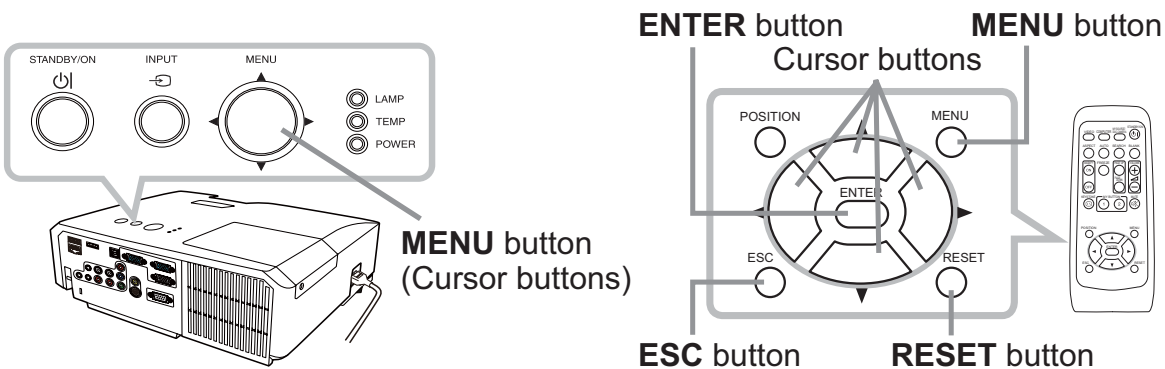

1. To start the MENU, press the **MENU** button. The MENU you last used (EASY or ADVANCED) will appear. EASY MENU has priority to appear just after powered on.

2. In the EASY MENU

- (1) Use the ▲/▼ cursor buttons to select an item to operate. If you want to change it to the ADVANCED MENU, select the ADVANCED MENU.
- (2) Use the ◀/▶ cursor buttons to operate the item.

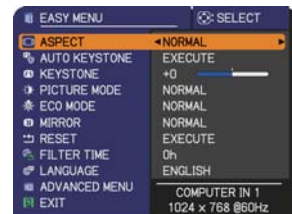

In the ADVANCED MENU

- (1) Use the ▲/▼ cursor buttons to select a menu. If you want to change it to the EASY MENU, select the EASY MENU. The items in the menu appear on the right side.
- (2) Press the ▶ cursor button or **ENTER** button to move the cursor to the right side. Then use the ▲/▼ cursor buttons to select an item to operate and press the ▶ cursor button or **ENTER** button to progress. The operation menu or dialog of the selected item will appear.
- (3) Use the buttons as instructed in the OSD to operate the item.



(continued on next page)

Using the menu function (continued)

3. To close the MENU, press the **MENU** button again or select EXIT and press the ◀ cursor button or **ENTER** button. Even if you do not do anything, the dialog will automatically disappear after about 30 seconds.
 - If you want to move the menu position, use the cursor buttons after pressing the **POSITION** button.
 - Some functions cannot be performed when a certain input port is selected, or when a certain input signal is displayed.
 - When you want to reset the operation, press **RESET** button on the remote control during the operation. Note that some items (ex. LANGUAGE, VOLUME) cannot be reset.
 - In the ADVANCED MENU, when you want to return to the previous display, press the ◀ cursor button or **ESC** button on the remote control.

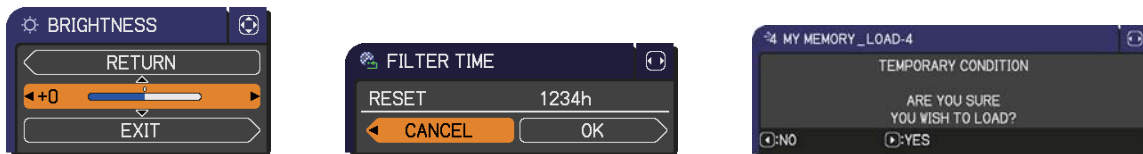
Indication in OSD (On Screen Display)

The meanings of the general words on the OSD are as follows.

Indication	Meaning
EXIT	Selecting this word finishes the OSD menu. It's the same as pressing the MENU button.
RETURN	Selecting this word returns the menu to the previous menu.
CANCEL or NO	Selecting this word cancels the operation in the present menu and returns to the previous menu.
OK or YES	Selecting this word executes the prepared function or shifts the menu to the next menu.

EASY MENU

EASY MENU

From the EASY MENU, items shown in the table below can be performed.

Select an item using the ▲/▼ cursor buttons. Then perform it according to the following table.

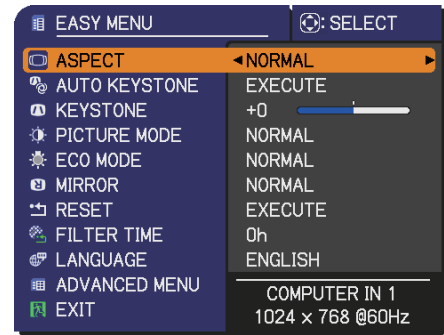

Item	Description																								
ASPECT	Using the ◀/▶ buttons switches the mode for aspect ratio. See the ASPECT item in IMAGE menu (📖33).																								
AUTO KEYSTONE	Using the ▶ button executes the auto keystone function. See the AUTO KEYSTONE (EXECUTE) item in SETUP menu (📖40).																								
KEYSTONE	Using the ◀/▶ buttons corrects the vertical keystone distortion. See the KEYSTONE item in SETUP menu (📖40).																								
PICTURE MODE	<p>Using the ◀/▶ buttons switches the picture mode. The picture modes are combinations of GAMMA and COLOR TEMP settings. Choose a suitable mode according to the projected source.</p> <p> </p> <table border="1"> <thead> <tr> <th></th> <th>GAMMA</th> <th>COLOR TEMP</th> </tr> </thead> <tbody> <tr> <td>NORMAL</td> <td>1 DEFAULT</td> <td>2 MID</td> </tr> <tr> <td>CINEMA</td> <td>2 DEFAULT</td> <td>3 LOW</td> </tr> <tr> <td>DYNAMIC</td> <td>3 DEFAULT</td> <td>1 HIGH</td> </tr> <tr> <td>BOARD(BLACK)</td> <td>4 DEFAULT</td> <td>4 Hi-BRIGHT-1</td> </tr> <tr> <td>BOARD(GREEN)</td> <td>4 DEFAULT</td> <td>5 Hi-BRIGHT-2</td> </tr> <tr> <td>WHITEBOARD</td> <td>5 DEFAULT</td> <td>2 MID</td> </tr> <tr> <td>DAYTIME</td> <td>6 DEFAULT</td> <td>6 Hi-BRIGHT-3</td> </tr> </tbody> </table> <ul style="list-style-type: none"> • When the combination of GAMMA and COLOR TEMP differs from pre-assigned modes above, the display on the menu for the PICTURE MODE is “CUSTOM”. Please refer to the GAMMA and COLOR TEMP (📖30, 31) items in PICTURE menu. • Lines or other noise might appear on the screen when this function is operated, but it is not a malfunction. 		GAMMA	COLOR TEMP	NORMAL	1 DEFAULT	2 MID	CINEMA	2 DEFAULT	3 LOW	DYNAMIC	3 DEFAULT	1 HIGH	BOARD(BLACK)	4 DEFAULT	4 Hi-BRIGHT-1	BOARD(GREEN)	4 DEFAULT	5 Hi-BRIGHT-2	WHITEBOARD	5 DEFAULT	2 MID	DAYTIME	6 DEFAULT	6 Hi-BRIGHT-3
	GAMMA	COLOR TEMP																							
NORMAL	1 DEFAULT	2 MID																							
CINEMA	2 DEFAULT	3 LOW																							
DYNAMIC	3 DEFAULT	1 HIGH																							
BOARD(BLACK)	4 DEFAULT	4 Hi-BRIGHT-1																							
BOARD(GREEN)	4 DEFAULT	5 Hi-BRIGHT-2																							
WHITEBOARD	5 DEFAULT	2 MID																							
DAYTIME	6 DEFAULT	6 Hi-BRIGHT-3																							

(continued on next page)

Item	Description
ECO MODE	Using the ◀/▶ buttons turns off/on the Eco mode. See the ECO MODE item in SETUP menu (📖41).
MIRROR	Using the ◀/▶ buttons switches the mode for mirror status. See the MIRROR item in SETUP menu (📖41).
RESET	Performing this item resets all of the EASY MENU items except the FILTER TIME and LANGUAGE. A dialog is displayed for confirmation. Selecting the OK using the ▶ button performs resetting.
FILTER TIME	The usage time of the air filter is shown in the menu. Performing this item resets the filter time which counts usage time of the air filter. A dialog is displayed for confirmation. Selecting the OK using the ▶ button performs resetting. See the FILTER TIME item in OPTION menu (📖52).
LANGUAGE	Using the ◀/▶ buttons changes the display language. See the LANGUAGE item in SCREEN menu (📖44).
ADVANCED MENU	Press the ▶ or ENTER button to use the menu of PICTURE, IMAGE, INPUT, SETUP, AUDIO, SCREEN, OPTION, NETWORK or SECURITY.
EXIT	Press the ◀ or ENTER button to finish the OSD menu.



PICTURE menu

PICTURE menu



From the PICTURE menu, items shown in the table below can be performed.

Select an item using the ▲/▼ cursor buttons, and press the ► cursor button or **ENTER** button to execute the item. Then perform it according to the following table.

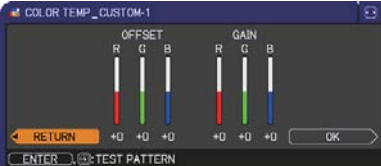
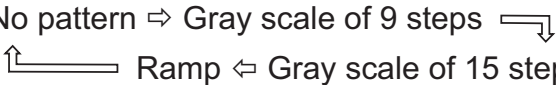

Item	Description
BRIGHTNESS	Using the ◀/▶ buttons adjusts the brightness. Dark ⇔ Light
CONTRAST	Using the ◀/▶ buttons adjusts the contrast. Weak ⇔ Strong
GAMMA	<p>Using the ▲/▼ buttons switches the gamma mode.</p> <p>1 DEFAULT ⇔ 1 CUSTOM ⇔ 2 DEFAULT ⇔ 2 CUSTOM ⇔ 3 DEFAULT ⇕ ⇕ ⇕ 6 CUSTOM ⇔ 3 CUSTOM ⇕ ⇕ 6 DEFAULT ⇔ 5 CUSTOM ⇔ 5 DEFAULT ⇔ 4 CUSTOM ⇔ 4 DEFAULT</p> <p>To adjust CUSTOM</p> <p>Selecting a mode whose name includes CUSTOM and then pressing the ► button or the ENTER button displays a dialog to aid you in adjusting the mode. This function is useful when you want to change the brightness of particular tones.</p>  <p>Choose an item using the ◀/▶ buttons, and adjust the level using the ▲/▼ buttons.</p> <p>You can display a test pattern for checking the effect of your adjustment by pressing the ENTER button. Each time you press the ENTER button, the pattern changes as below.</p> <p>No pattern ⇔ Gray scale of 9 steps ⇨ ⇨ Ramp ⇔ Gray scale of 15 steps</p>  <p>The eight equalizing bars correspond to eight tone levels of the test pattern (Gray scale of 9 steps) except the darkest in the left end. If you want to adjust the 2nd tone from left end on the test pattern, use the equalizing adjustment bar "1". The darkest tone at the left end of the test pattern cannot be controlled with any of equalizing adjustment bar.</p> <ul style="list-style-type: none"> • Lines or other noise might appear on the screen when this function is operated, but it is not a malfunction. 

(continued on next page)

Item	Description
<p>COLOR TEMP</p>	<p>Using the ▲/▼ buttons switches the color temperature mode.</p> <p style="text-align: center;"> 1 HIGH ⇔ 1 CUSTOM ⇔ 2 MID ⇔ 2 CUSTOM ⇕ ⇕ 6 CUSTOM 3 LOW ⇕ ⇕ 6 Hi-BRIGHT-3 3 CUSTOM ⇕ ⇕ 5 CUSTOM ⇔ 5 Hi-BRIGHT-2 ⇔ 4 CUSTOM ⇔ 4 Hi-BRIGHT-1 </p> <p>To adjust CUSTOM</p> <p>Selecting a mode whose name includes CUSTOM and then pressing the ► button or the ENTER button displays a dialog to aid you in adjusting the OFFSET and GAIN of the selected mode.</p>  <p>OFFSET adjustments change the color intensity on the whole tones of the test pattern.</p> <p>GAIN adjustments mainly affect color intensity on the brighter tones of the test pattern.</p> <p>Choose an item using the ◀/▶ buttons, and adjust the level using the ▲/▼ buttons.</p> <p>You can display a test pattern for checking the effect of your adjustment by pressing the ENTER button.</p> <p>Each time you press the ENTER button, the pattern changes as below.</p> <p>No pattern ⇔ Gray scale of 9 steps ⇔ Ramp ⇔ Gray scale of 15 steps</p>  <p>• Lines or other noise might appear on the screen when this function is operated, but it is not a malfunction.</p> 
<p>COLOR</p>	<p>Using the ◀/▶ buttons adjusts the strength of whole color.</p> <p>Weak ⇔ Strong</p> <ul style="list-style-type: none"> • This item can be selected only for a video, s-video and component video signal. • For an HDMI signal, this item can also be selected if either (1) or (2) applies. (1) HDMI FORMAT item in the INPUT menu is set to VIDEO. (2) HDMI FORMAT item in the INPUT menu is set to AUTO, and the projector recognizes that it receives video signals.
<p>TINT</p>	<p>Using the ◀/▶ buttons adjusts the tint.</p> <p>Reddish ⇔ Greenish</p> <ul style="list-style-type: none"> • This item can be selected only for a video, s-video and component video signal. • For an HDMI signal, this item can also be selected if either (1) or (2) applies. (1) HDMI FORMAT item in the INPUT menu is set to VIDEO. (2) HDMI FORMAT item in the INPUT menu is set to AUTO, and the projector recognizes that it receives video signals.

(continued on next page)

PICTURE menu

Item	Description
SHARPNESS	<p>Using the ◀/▶ buttons adjusts the sharpness. Weak ⇔ Strong</p> <ul style="list-style-type: none"> • There may be some noise and/or the screen may flicker for a moment when an adjustment is made. This is not a malfunction.
ACTIVE IRIS	<p>Using the ▲/▼ cursor buttons changes the active iris control mode. PRESENTATION ⇔ THEATER ⇔ OFF</p> <p style="text-align: center;">↑—————↑</p> <p><u>PRESENTATION</u> : The active iris displays the best presentation image for both bright and dark scenes. <u>THEATER</u> : The active iris displays the best theater image for both bright and dark scenes. <u>OFF</u> : The active iris is always open.</p> <ul style="list-style-type: none"> • The screen may flicker when the PRESENTATION or THEATER modes are selected. If this occurs select OFF.
MY MEMORY	<p>This projector has 4 memories for adjustment data (for all the items of the PICTURE menu). Selecting a function using the ▲/▼ buttons and pressing the ▶ or ENTER button performs each function.</p> <p style="text-align: center;">↻ SAVE-1 ⇔ SAVE-2 ⇔ SAVE-3 ⇔ SAVE-4 ↻ ↻ LOAD-4 ⇔ LOAD-3 ⇔ LOAD-2 ⇔ LOAD-1 ↻</p> <p><u>SAVE-1, SAVE-2, SAVE-3, SAVE-4</u> Performing a SAVE function saves the current adjustment data into the memory linked in the number included in the function's name.</p> <ul style="list-style-type: none"> • Remember that the current data being stored of a memory will be lost by saving new data into the memory. <p><u>LOAD-1, LOAD-2, LOAD-3, LOAD-4</u> Performing a LOAD function loads the data from the memory linked in the number included in the function's name, and adjusts the picture automatically depending on the data.</p> <ul style="list-style-type: none"> • The LOAD functions whose linked memory has no data are skipped. • Remember that the current adjusted condition will be lost by loading data. If you want to keep the current adjustment, please save it before performing a LOAD function. • There may be some noise and the screen may flicker for a moment when loading data. This is not malfunction. • You can perform the LOAD function using MY BUTTON. Please see MY BUTTON item in OPTION menu (📖53).

IMAGE menu

From the IMAGE menu, items shown in the table below can be performed.

Select an item using the ▲/▼ cursor buttons, and press the ► cursor button or **ENTER** button to execute the item. Then perform it according to the following table.

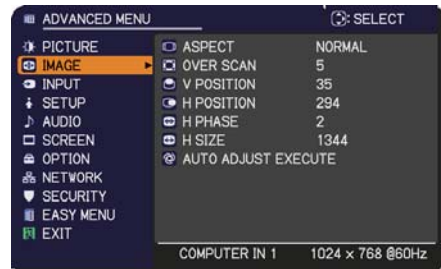

Item	Description
<p>ASPECT</p>	<p>Using the ▲/▼ buttons switches the mode for aspect ratio.</p> <p>For a computer signal NORMAL ⇔ 4:3 ⇔ 16:9 ⇔ 16:10 ⇔ NATIVE ↑</p> <p>For an HDMI signal NORMAL ⇔ 4:3 ⇔ 16:9 ⇔ 16:10 ⇔ 14:9 ⇔ NATIVE ↑</p> <p>For a video signal, s-video signal or component video signal 4:3 ⇔ 16:9 ⇔ 16:10 ⇔ 14:9 ⇔ NATIVE ↑</p> <p>For an input signal from the LAN, USB TYPE A or USB TYPE B port, or if there is no signal 16:10 (fixed) • The NORMAL mode keeps the original aspect ratio of the signal.</p>
<p>OVER SCAN</p>	<p>Using the ◀/▶ buttons adjusts the over-scan ratio. Small (It magnifies picture) ⇔ Large (It reduces picture)</p> <ul style="list-style-type: none"> • This item can be selected only for a video, s-video and component video signal. • For an HDMI signal, this item can also be selected if either (1) or (2) applies. <ol style="list-style-type: none"> (1) HDMI FORMAT item in the INPUT menu is set to VIDEO. (2) HDMI FORMAT item in the INPUT menu is set to AUTO, and the projector recognizes that it receives video signals.

(continued on next page)

IMAGE menu

Item	Description
V POSITION	<p>Using the ◀/▶ buttons adjusts the vertical position. Down ⇔ Up</p> <ul style="list-style-type: none"> • Over-adjusting the vertical position may cause noise to appear on the screen. If this occurs, please reset the vertical position to the default setting. Pressing the RESET button when the V POSITION is selected will reset the V POSITION to the default setting. • When this function is performed on a video signal or an s-video signal, the range of this adjustment depends on OVER SCAN (📖33) setting. It is not possible to adjust when OVER SCAN is set to 10. • This function is unavailable for a signal from the LAN, USB TYPE A, USB TYPE B or HDMI port.
H POSITION	<p>Using the ◀/▶ buttons adjusts the horizontal position. Right ⇔ Left</p> <ul style="list-style-type: none"> • Over-adjusting the horizontal position may cause noise to appear on the screen. If this occurs, please reset the horizontal position to the default setting. Pressing the RESET button when the H POSITION is selected will reset the H POSITION to the default setting. • When this function is performed on a video signal or an s-video signal, the range of this adjustment depends on OVER SCAN (📖33) setting. It is not possible to adjust when OVER SCAN is set to 10. • This function is unavailable for a signal from the LAN, USB TYPE A, USB TYPE B or HDMI port.

(continued on next page)

Item	Description
H PHASE	<p>Using the ◀/▶ buttons adjusts the horizontal phase to eliminate flicker. Right ⇔ Left</p> <ul style="list-style-type: none"> • This item can be selected only for a computer signal or a component video signal. This function is unavailable for a signal from the LAN, USB TYPE A, USB TYPE B or HDMI port.
H SIZE	<p>Using the ◀/▶ buttons adjusts the horizontal size. Small ⇔ Large</p> <ul style="list-style-type: none"> • This item can be selected only for a computer signal. This function is unavailable for a signal from the LAN, USB TYPE A, USB TYPE B or HDMI port. • When this adjustment is excessive, the picture may not be displayed correctly. In such a case, please reset the adjustment by pressing the RESET button on the remote control during this operation. • Images might appear degraded when this function is operated, but it is not a malfunction.
AUTO ADJUST EXECUTE	<p>Selecting this item performs the automatic adjustment feature.</p> <p>For a computer signal The vertical position, the horizontal position and the horizontal phase will be automatically adjusted. Make sure that the application window is set to its maximum size prior to attempting to use this feature. A dark picture may still be incorrectly adjusted. Use a bright picture when adjusting.</p> <p>For a video signal and s-video signal The video format best suited for the respective input signal will be selected automatically. This function is available only when the AUTO is selected for the VIDEO FORMAT item in the INPUT menu (📖 37). The vertical position and horizontal position will be automatically set to the default.</p> <p>For a component video signal The vertical position and horizontal position will be automatically set to the default. The horizontal phase will be automatically adjusted.</p> <ul style="list-style-type: none"> • The automatic adjustment operation requires approx. 10 seconds. Also please note that it may not function correctly with some input. • When this function is performed for a video signal, a certain extra such as a line may appear outside a picture. • When this function is performed for a computer signal, a black frame may be displayed on the edge of the screen, depending on the PC model. • The items adjusted by this function may vary when the FINE or DISABLE is selected for the AUTO ADJUST item of the SERVICE item in the OPTION menu (📖 55).

INPUT menu

INPUT menu

From the INPUT menu, items shown in the table below can be performed.

Select an item using the ▲/▼ cursor buttons, and press the ► cursor button or **ENTER** button to execute the item. Then perform it according to the following table.

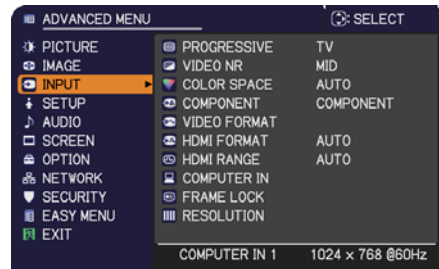



Item	Description
PROGRESSIVE	<p>Using the ▲/▼ buttons switches the progress mode.</p> <p>TV ⇄ FILM ⇄ OFF</p> <p>↑—————↑</p> <ul style="list-style-type: none"> • This function works only for a video signal, s-video signal, component video signal (of 480i@60 or 576i@50 or 1080i@50/60) and an HDMI signal (of 480i@60 or 576i@50 or 1080i@50/60). • When TV or FILM is selected, the screen image will be sharp. FILM adapts to the 2-3 Pull-Down conversion system. But these may cause a certain defect (for example, jagged line) of the picture for a quick moving object. In such a case, please select OFF, even though the screen image may lose sharpness.
VIDEO NR	<p>Using the ▲/▼ buttons switches the noise reduction mode.</p> <p>HIGH ⇄ MID ⇄ LOW</p> <p>↑—————↑</p> <ul style="list-style-type: none"> • This function works only for a video signal, s-video signal, component video signal (of 480i@60 or 576i@50 or 1080i@50/60) and an HDMI signal (of 480i@60 or 576i@50 or 1080i@50/60).
COLOR SPACE	<p>Using the ▲/▼ buttons switches the mode for color space.</p> <p>AUTO ⇄ RGB ⇄ SMPTE240 ⇄ REC709 ⇄ REC601</p> <p>↑—————↑</p> <ul style="list-style-type: none"> • This item can be selected only for a computer signal (except for signals from the LAN, USB TYPE A and USB TYPE B ports) or a component video signal (except SCART RGB). • The AUTO mode automatically selects the optimum mode. • The AUTO operation may not work well at some signals. In such a case, it might be good to select a suitable mode except AUTO.
COMPONENT	<p>Using the ▲/▼ buttons switches the function of the COMPONENT (Y, Cb/Pb, Cr/Pr) port.</p> <p>COMPONENT ⇄ SCART RGB</p> <p>When the SCART RGB is selected, the COMPONENT (Y, Cb/Pb, Cr/Pr) and VIDEO ports will function as a SCART RGB port. A SCART adapter or SCART cable is required for a SCART RGB input to the projector. For details, contact your dealer.</p>

(continued on next page)



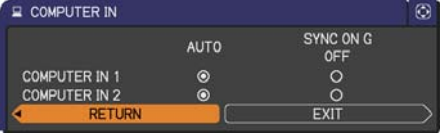

Item	Description								
<p>VIDEO FORMAT</p>	<p>The video format for S-VIDEO port and VIDEO port can be set.</p> <p>(1) Use the ▲/▼ buttons to select the input port.</p> <p>(2) Using the ◀/▶ buttons switches the mode for video format.</p>  <p>AUTO ⇔ NTSC ⇔ PAL ⇔ SECAM ↷ N-PAL ⇔ M-PAL ⇔ NTSC4.43 ↶</p> <ul style="list-style-type: none"> • This item is performed only for a video signal from the VIDEO port or the S-VIDEO port. • The AUTO mode automatically selects the optimum mode. • The AUTO operation may not work well for some signals. If the picture becomes unstable (e.g. an irregular picture, lack of color), please select the mode according to the input signal. 								
<p>HDMI FORMAT</p>	<p>Using the ▲/▼ cursor buttons switches the video format for an input from the HDMI port.</p> <p>AUTO ⇔ VIDEO ⇔ COMPUTER</p> <table border="1" data-bbox="477 953 1425 1136"> <thead> <tr> <th></th> <th>Feature</th> </tr> </thead> <tbody> <tr> <td>AUTO</td> <td>automatically sets the optimum mode.</td> </tr> <tr> <td>VIDEO</td> <td>sets the suitable mode for DVD signals.</td> </tr> <tr> <td>COMPUTER</td> <td>sets the suitable mode for computer signals.</td> </tr> </tbody> </table> <ul style="list-style-type: none"> • When the COMPUTER is selected, the functions COLOR (PICTURE menu), TINT (PICTURE menu) and OVER SCAN (IMAGE menu) are unavailable. 		Feature	AUTO	automatically sets the optimum mode.	VIDEO	sets the suitable mode for DVD signals.	COMPUTER	sets the suitable mode for computer signals.
	Feature								
AUTO	automatically sets the optimum mode.								
VIDEO	sets the suitable mode for DVD signals.								
COMPUTER	sets the suitable mode for computer signals.								
<p>HDMI RANGE</p>	<p>Using the ▲/▼ cursor buttons changes the digital range for input from the HDMI port.</p> <p>AUTO ⇔ NORMAL ⇔ ENHANCED</p> <table border="1" data-bbox="477 1436 1425 1619"> <thead> <tr> <th></th> <th>Feature</th> </tr> </thead> <tbody> <tr> <td>AUTO</td> <td>automatically sets the optimum mode.</td> </tr> <tr> <td>NORMAL</td> <td>sets the suitable mode for DVD signals. (16-235)</td> </tr> <tr> <td>ENHANCED</td> <td>sets the suitable mode for computer signals. (0-255)</td> </tr> </tbody> </table> <ul style="list-style-type: none"> • If the contrast of the screen image is too strong or too weak, try finding a more suitable mode. 		Feature	AUTO	automatically sets the optimum mode.	NORMAL	sets the suitable mode for DVD signals. (16-235)	ENHANCED	sets the suitable mode for computer signals. (0-255)
	Feature								
AUTO	automatically sets the optimum mode.								
NORMAL	sets the suitable mode for DVD signals. (16-235)								
ENHANCED	sets the suitable mode for computer signals. (0-255)								

(continued on next page)

INPUT menu

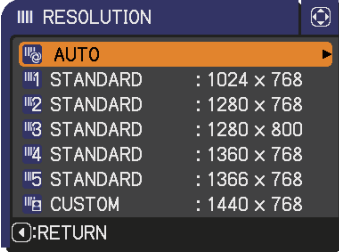
Item	Description
<p>COMPUTER IN</p>	<p>The computer input signal type for COMPUTER IN1 and IN2 ports can be set.</p> <p>(1) Use the ▲/▼ buttons to select the COMPUTER IN port to be set.</p> <p>(2) Use the ◀/▶ buttons to select the computer input signal type.</p> <p style="text-align: center;">AUTO ⇔ SYNC ON G OFF</p> <ul style="list-style-type: none"> • Selecting the AUTO mode allows you to input a sync on G signal or component video signal from the port. Please refer to “Technical” for the connection of component video input to COMPUTER IN1/2 port. • In the AUTO mode, the picture may be distorted with certain input signals. In such a case, remove the signal connector so that no signal is received and select the SYNC ON G OFF, and then reconnect the signal. 
<p>FRAME LOCK</p>	<p>Set the frame lock function on/off for each port.</p> <p>(1) Use the ▲/▼ buttons to select the input ports.</p> <p>(2) Use the ◀/▶ buttons to turn the frame lock function on/off .</p> <p style="text-align: center;">ON ⇔ OFF</p> <ul style="list-style-type: none"> • This item can be performed only on a signal with a vertical frequency of 49 to 51Hz, 59 to 61 Hz. • When ON is selected, moving pictures are displayed more smoothly. 

(continued on next page)

Item	Description
<p>RESOLUTION</p>	<p>The resolution for the COMPUTER IN1 and COMPUTER IN2 input signals can be set on this projector.</p> <p>(1) In the INPUT menu select the RESOLUTION using the ▲/▼ buttons and press the ► button. The RESOLUTION menu will be displayed.</p>  <p>(2) In the RESOLUTION menu select the resolution you wish to display using the ▲/▼ buttons. Selecting AUTO will set a resolution appropriate to the input signal.</p> <p>(3) Pressing the ► or ENTER button when selecting a STANDARD resolution will automatically adjust the horizontal and vertical positions, clock phase and horizontal size. The INPUT_INFORMATION dialog will be displayed.</p>  <p>(4) To set a custom resolution use the ▲/▼ buttons to select the CUSTOM and the RESOLUTION_CUSTOM box will be displayed. Set the horizontal (HORZ) and vertical (VERT) resolutions using the ▲/▼/◀/▶ buttons. This function may not support all resolutions.</p>  <p>(5) Move the cursor to OK on screen and press the ► or ENTER button. The message "ARE YOU SURE YOU WISH TO CHANGE RESOLUTION?" appears. To save the setting, press the ► button. The horizontal and vertical positions, clock phase and horizontal size will be automatically adjusted. The INPUT_INFORMATION dialog will be displayed.</p>  <p>(6) To revert back to the previous resolution without saving changes, move the cursor to CANCEL on screen and press the ◀ or ENTER button. The screen will then return to the RESOLUTION menu displaying the previous resolution.</p> <ul style="list-style-type: none"> • For some pictures, this function may not work well.

SETUP menu

SETUP menu

From the SETUP menu, items shown in the table below can be performed.

Select an item using the ▲/▼ cursor buttons, and press the ► cursor button or **ENTER** button to execute the item. Then perform it according to the following table.

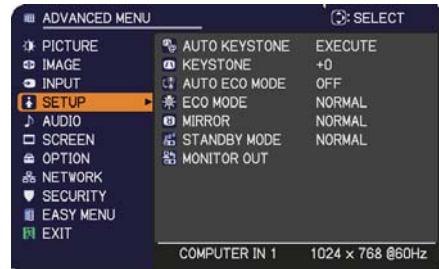

Item	Description
AUTO KEYSTONE	<p>Selecting this item performs the Automatic keystone distortion correction. Projector automatically corrects vertical keystone distortion due to the (forward/backward) setup angle by itself. This function will be executed only once when selected in the menu. When the slant of the projector is changed, execute this function again.</p> <ul style="list-style-type: none"> • The adjustable range of this function will vary among inputs. For some input, this function may not work well. • When V:INVERT or H&V:INVERT is selected to the MIRROR item in the SETUP menu, if the projector screen is inclined or angled downward, this function may not work correctly. • When the zoom adjustment is set to the TELE (telephoto focus), this function may be excessive. This function should be used when the zoom adjustment is set to the full WIDE (wide-angle focus) whenever possible. • When the projector is placed on the level (about ±4°), this function may not work. • When the projector is inclined to near ±30 degree or over, this function may not work well. • This function will be unavailable when the Transition Detector is on (📖70).
KEYSTONE	<p>Using the ◀/▶ buttons corrects the vertical keystone distortion. Shrink the bottom of the image ⇔ Shrink the top of the image</p> <ul style="list-style-type: none"> • The adjustable range of this function will vary among inputs. For some input, this function may not work well. • When the zoom adjustment is set to the TELE (telephoto focus), this function may be excessive. This function should be used when the zoom adjustment is set to the full WIDE (wide-angle focus) whenever possible. • This function will be unavailable when the Transition Detector is on (📖70).
AUTO ECO MODE	<p>Using the ▲/▼ buttons turns on/off the AUTO ECO MODE. ON ⇔ OFF</p> <ul style="list-style-type: none"> • When ON is selected, the projector will always be set to Eco mode at start-up regardless of the ECO MODE (📖41) setting. An OSD message “AUTO ECO MODE” will be displayed for tens of seconds when the projector starts with this function activated.



(continued on next page)

AUDIO menu

AUDIO menu

From the AUDIO menu, items shown in the table below can be performed. Select an item using the ▲/▼ cursor buttons, and press the ► cursor button or the **ENTER** button to execute the item. Then perform it according to the following table.



Item	Description
VOLUME	Using the ◀/▶ buttons adjusts the volume. Low ⇄ High
SPEAKER	Using the ▲/▼ buttons turns on/off the built-in speaker. ON ⇄ OFF When OFF is selected, the built-in speaker does not work.
AUDIO SOURCE	<p>While the image signal from the input port chosen in step (1) is projected, the audio signal from the input port selected in step (2) is output to both the AUDIO OUT port and built-in speaker of this projector. However, the built-in speaker does not work when SPEAKER is set to OFF.</p> <p>(1) Choose a picture input port using the ▲/▼ buttons. Choose STANDBY to select the sound output in the standby mode.</p> <p>(2) Select one of the AUDIO IN ports using ◀/▶ buttons. Select  to mute the sound from the input port or in the standby mode chosen in the step (1).</p> <p>• In the AUDIO SOURCE window, “H” symbolizes the audio signal from the HDMI port. It can be selected only for the picture input from the HDMI port.</p> <p>• Even if the projector is in the standby mode, cooling fans may work and make noises when the built-in speaker is in operation.</p> <p>• C.C. (Closed Caption) is automatically activated when  is selected and an input signal containing C.C. is received. This function is available only when the signal is NTSC for VIDEO or S-VIDEO, or 480i@60 for COMPONENT, COMPUTER IN1 or COMPUTER IN2, and when AUTO is selected for DISPLAY in the C.C. menu under the SCREEN menu ( 49).</p>

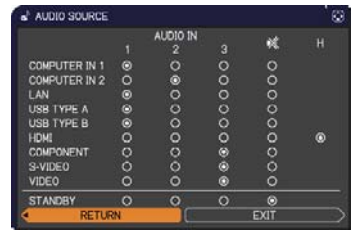

(continued on next page)

Item	Description
HDMI AUDIO	Using the ▲/▼ buttons switches the mode for the HDMI audio. Check each of the two modes provided and select the suitable one for your HDMI audio device. 1 ⇔ 2
MIC LEVEL	Using the ▲/▼ buttons switches the input level to match that of the microphone connected to the MIC port. HIGH ⇔ LOW HIGH: for a microphone with an amplifier. LOW: for a microphone without an amplifier.
MIC VOLUME	Using the ◀/▶ buttons adjusts the volume of the microphone connected to the MIC port. Low ⇔ High

SCREEN menu

SCREEN menu

From the SCREEN menu, items shown in the table below can be performed.

Select an item using the ▲/▼ cursor buttons, and press the ► cursor button or **ENTER** button to execute the item. Then perform it according to the following table.



Item	Description
<p>LANGUAGE</p>	<p>Using the ▲/▼/◀/▶ buttons switches the OSD (On Screen Display) language.</p> <p>ENGLISH ⇄ FRANÇAIS ⇄ DEUTSCH ⇄ ESPAÑOL ⤴ (shown in the LANGUAGE dialog) ⤵</p> <p>Press the ENTER or INPUT button to save the language setting.</p>
<p>MENU POSITION</p>	<p>Using the ▲/▼/◀/▶ buttons adjusts the menu position. To quit the operation, press the MENU button on the remote control or keep no operation for about 10 seconds.</p>
<p>BLANK</p>	<p>Using the ▲/▼ buttons switches the mode for the blank screen. The blank screen is a screen for the temporarily blanking feature (📖25). It is displayed by pressing the BLANK button on the remote control.</p> <p>MyScreen ⇄ ORIGINAL ⇄ BLUE ⇄ WHITE ⇄ BLACK ⤴—————⤵</p> <p><u>MyScreen</u> : Screen can be registered by the MyScreen item (📖45). <u>ORIGINAL</u> : Screen preset as the standard screen. <u>BLUE, WHITE, BLACK</u> : Plain screens in each color.</p> <ul style="list-style-type: none"> • To avoid remaining as an afterimage, the MyScreen or ORIGINAL screen will change to the plain black screen after several minutes.
<p>START UP</p>	<p>Using the ▲/▼ buttons switches the mode for the start-up screen. The start-up screen is a screen displayed when no signal or an unsuitable signal is detected.</p> <p>MyScreen ⇄ ORIGINAL ⇄ OFF ⤴—————⤵</p> <p><u>MyScreen</u> : Screen can be registered by the MyScreen item (📖45). <u>ORIGINAL</u> : Screen preset as the standard screen. <u>OFF</u> : Plain black screen.</p> <ul style="list-style-type: none"> • To avoid remaining as an afterimage, the MyScreen or ORIGINAL screen will change to the BLANK screen (📖above) after several minutes. If also the BLANK screen is the MyScreen or ORIGINAL, the plain black screen is instead used. • When the ON is selected to the MyScreen PASSWORD item in the SECURITY menu (📖68), the START UP is fixed to MyScreen.

(continued on next page)

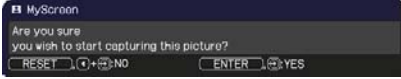
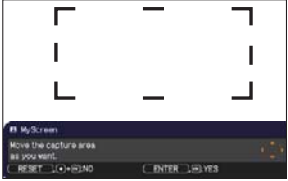
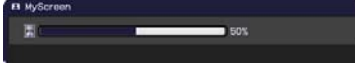
Item	Description
<p>MyScreen</p>	<p>This item allows you to capture an image for use as a MyScreen image which can be used as the BLANK screen and START UP screen. Display the image you want to capture before executing the following procedure.</p> <ol style="list-style-type: none"> <p>Selecting this item displays a dialog titled “MyScreen”. It will ask you if you start capturing an image from the current screen.</p>  <p>Please wait for the target image to be displayed, and press the ENTER or INPUT button when the image is displayed. The image will freeze and the frame for capturing will appear.</p> <p>To stop performing, press the RESET button on the remote control.</p> <p>Using the ▲/▼/◀/▶ buttons adjusts the frame position.</p>  <p>Please move the frame to the position of the image which you want to use. The frame may not be able to be moved for some input signals.</p> <p>To start registration, press the ENTER or INPUT button on the remote control.</p>  <p>To restore the screen and return to the previous dialog, press the RESET button on the remote control.</p> <p>Registration takes several minutes.</p> <p>When the registration is completed, the registered screen and the following message is displayed for several seconds:</p> <p>“MyScreen registration is finished.”</p> <p>If the registration failed, the following message is displayed:</p> <p>“A capturing error has occurred. Please try again.”</p> <ul style="list-style-type: none"> • This function cannot be selected when the ON is selected to the MyScreen Lock item (46). • This function cannot be selected when the ON is selected to the MyScreen PASSWORD item in SECURITY menu (68). • This function is unavailable for a signal from the LAN, USB TYPE A, USB TYPE B or HDMI port.

(continued on next page)

SCREEN menu

Item	Description
MyScreen Lock	<p>Using the ▲/▼ buttons turns on/off the MyScreen lock function. ON ⇔ OFF</p> <p>When the ON is selected, the item MyScreen is locked. Use this function for protecting the current MyScreen.</p> <ul style="list-style-type: none"> • This function cannot be selected when the ON is selected to the MyScreen PASSWORD item in SECURITY menu (📖68).
MESSAGE	<p>Using the ▲/▼ buttons turns on/off the message function. ON ⇔ OFF</p> <p>When the ON is selected, the following message function works.</p> <p>“AUTO IN PROGRESS” while automatically adjusting “NO INPUT IS DETECTED” “SYNC IS OUT OF RANGE” “INVALID SCAN FREQ.” “Searching....” while searching for the input “Detecting....” while an input signal is detected “AUTO ECO MODE” while starting up with AUTO ECO MODE</p> <p>The indication of the input signal displayed by changing The indication of the aspect ratio displayed by changing The indication of the PICTURE MODE displayed by changing The indication of the ACTIVE IRIS displayed by changing The indication of the MY MEMORY displayed by changing The indication of “FREEZE” and “II” while freezing the screen by pressing the FREEZE button. The indication of the TEMPLATE displayed by changing.</p> <ul style="list-style-type: none"> • When the OFF is selected, please remember if the picture is frozen. Do not mistake freezing for a malfunction (📖25).

(continued on next page)

Item	Description
<p>SOURCE NAME</p>	<p>Each input port for this projector can have a name applied to it.</p> <p>(1) Use the ▲/▼ buttons on the SCREEN menu to select SOURCE NAME and press the ► or ENTER button. The SOURCE NAME menu will be displayed.</p> <p>(2) Use the ▲/▼ buttons on the SOURCE NAME menu to select the port to be named and press the ► button. The SOURCE NAME dialog will be displayed. Right side of the menu is blank until a name is specified.</p> <p>(3) Select an icon you'd like to assign to the port in the SOURCE NAME dialog. The name assigned to the port will also be automatically switched according to your icon selection. Press the ► or ENTER button to determine your icon selection.</p> <p>(4) Select a number you'd like to assign to the port along with the icon. You can select the number either from blank (no number assigned), 1, 2, 3, or 4.</p> <p>(5) If you'd like to modify the name assigned to the port, select CUSTOM NAME and press the ► button.</p>



(continued on next page)

SCREEN menu

Item	Description
<p>SOURCE NAME (Continued)</p>	<p>(6) The current name will be displayed on the first line. Use the ▲/▼/◀/▶ buttons and the ENTER or INPUT button to select and enter characters. To erase 1 character at one time, press the RESET button or press the ◀ and INPUT button at the same time. Also if you move the cursor to DELETE or ALL CLEAR on screen and press the ENTER or INPUT button, 1 character or all characters will be erased. The name can be a maximum of 16 characters.</p> <p>(7) To change an already inserted character, press the ▲ button to move the cursor to the first line, and use the ◀/▶ buttons to move the cursor on the character to be changed.</p> <p>After pressing the ENTER or INPUT button, the character is selected. Then, follow the same procedure as described at the item (6) above.</p> <p>(8) To finish entering text, move the cursor to the OK on screen and press the ▶, ENTER or INPUT button. To revert to the previous name without saving changes, move the cursor to the CANCEL on screen and press the ◀, ENTER or INPUT button.</p> 
<p>TEMPLATE</p>	<p>Using the ▲/▼ cursor buttons switches the mode for the template screen.</p> <p>Press the ▶ cursor (or the ENTER) button to display the selected template, and press the ◀ cursor button to close the displayed screen.</p> <p>The last selected template is displayed when the MY BUTTON allocated to the TEMPLATE function is pressed (48).</p> <p style="text-align: center;">TEST PATTERN ⇔ DOT-LINE1 ⇔ DOT-LINE2 ⇔ DOT-LINE3</p> <p style="text-align: center;">⇕</p> <p style="text-align: center;">MAP2 ⇔ MAP1 ⇔ CIRCLE2 ⇔ CIRCLE1 ⇔ DOT-LINE4</p> <p style="text-align: center;">⇕</p> <p>You can turn a map upside down and scroll it horizontally when MAP1 or MAP2 is selected. To invert or scroll the map, display the guidance by pressing the RESET button on the remote three seconds or more when MAP1 or MAP2 appears.</p>

(continued on next page)

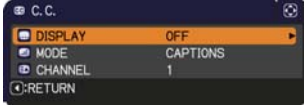
Item	Description
<p>C.C. (Closed Caption)</p>	<p>The C.C. is the function that displays a transcript or dialog of the audio portion of a video, files or other presentation or other relevant sounds. It is required to have NTSC format video or 480i@60 format component video source supporting C.C. feature to utilize this function.</p> <p>It may not work properly, depending on equipment or signal source. In this case, please turn off the Closed Caption.</p> 
	<p>DISPLAY</p> <p>Select Closed Caption DISPLAY setting from following options using ▲/▼ buttons.</p> <p>AUTO ⇔ ON ⇔ OFF</p> <p style="text-align: center;">↑—————↑</p> <p><u>AUTO</u> : Closed Caption automatically displays when the volume is muted.</p> <p><u>ON</u> : Closed Caption is on.</p> <p><u>OFF</u> : Closed Caption is off.</p> <ul style="list-style-type: none"> • The caption is not displayed when the OSD menu is active. • The Closed Caption is the function to display the dialogue, narration, and / or sound effects of a television program or other video sources. The Closed Caption availability is depending upon broadcaster and/or content.
	<p>MODE</p> <p>Select Closed Caption MODE setting from following options using ▲/▼ buttons.</p> <p>CAPTIONS ⇔ TEXT</p> <p><u>CAPTIONS</u> : Display Closed Caption.</p> <p><u>TEXT</u> : Display Text data, which is for additional information such as news reports or a TV program guide. The information covers the entire screen. Not all of the C.C. program has Text information.</p>
	<p>CHANNEL</p> <p>Select Closed Caption CHANNEL from following options using ▲/▼ buttons.</p> <p>1 ⇔ 2 ⇔ 3 ⇔ 4</p> <p style="text-align: center;">↑—————↑</p> <p><u>1</u>: Channel 1, primary channel / language</p> <p><u>2</u>: Channel 2</p> <p><u>3</u>: Channel 3</p> <p><u>4</u>: Channel 4</p> <p>The channel data may vary, depending on the content. Some channel might be used for secondary language or empty.</p>

OPTION menu

OPTION menu



From the OPTION menu, items shown in the table below can be performed.

Select an item using the ▲/▼ cursor buttons, and press the ► cursor button or **ENTER** button to execute the item, except for the items LAMP TIME and FILTER TIME. Then perform it according to the following table.



Item	Description
<p>AUTO SEARCH</p>	<p>Using the ▲/▼ buttons turns on/off the automatic signal search function.</p> <p>ON ⇔ OFF</p> <p>When the ON is selected, detecting no signal automatically cycles through input ports in the following order. The search is started from the current port. Then when an input is found, the projector will stop searching and display the image.</p> <p> </p> <ul style="list-style-type: none"> • It may take several seconds to project the images from the USB TYPE B port.
<p>AUTO KEYSTONE</p>	<p>Using the ▲/▼ buttons turns on/off the automatic keystone function.</p> <p>ON ⇔ OFF</p> <p><u>ON</u> : Automatic keystone distortion correction will be executed whenever changing the slant of the projector.</p> <p><u>OFF</u> : This function is disabled. Please execute the AUTO KEYSTONE (EXECUTE) in the SETUP menu for automatic keystone distortion correction.</p> <ul style="list-style-type: none"> • When the projector is suspended from the ceiling this feature will not function properly so select the OFF. • This function will be unavailable when the Transition Detector is on (70).
<p>DIRECT POWER ON</p>	<p>Using the ▲/▼ buttons turns on/off the DIRECT POWER ON function.</p> <p>ON ⇔ OFF</p> <p>When set to the ON, the lamp in projector will be automatically turned on without the usual procedure (17), only when the projector is supplied with the power after the power was cut while the lamp was on.</p> <ul style="list-style-type: none"> • This function does not work as long as the power has been supplied to the projector while the lamp is off. • After turning the lamp on by the DIRECT POWER ON function, if neither input nor operation is detected for about 30 minutes, the projector is turned off, even though the AUTO POWER OFF function (51) is disabled.

(continued on next page)



Item	Description
<p>AUTO POWER OFF</p>	<p>Using the ▲/▼ buttons adjusts the time to count down to automatically turn the projector off.</p> <p>Long (max. 99 minutes) ⇔ Short (min. 0 minute = DISABLE)</p> <div style="display: flex; justify-content: space-around; align-items: center;">   </div> <p>When the time is set to 0, the projector is not turned off automatically. When the time is set to 1 to 99, and when the passed time with no-signal or an unsuitable signal reaches at the set time, the projector lamp will be turned off.</p> <p>If one of the projector's buttons or the remote control buttons is pressed or one of the commands (except get commands) is transmitted to the CONTROL port during the corresponding time, projector will not be turned off.</p> <p>Please refer to the section “Turning off the power” (📖17).</p>
<p>USB TYPE B</p>	<p>Using the ▲/▼ buttons selects the function of USB TYPE B port. To use this function, you need to connect the USB TYPE B port of the projector and the type A USB port of a computer.</p> <p>MOUSE ⇔ USB DISPLAY</p> <p>MOUSE : The accessory remote control works as the simple mouse and keyboard of the computer.</p> <p>USB DISPLAY : The port works as an input port that receives image signals from the computer (📖82).</p> <ul style="list-style-type: none"> • It may take several seconds to project the images from the USB TYPE B port. • In the following cases, a message to notify you that USB TYPE B port is not available for picture input appears together with the USB TYPE B dialog: <ul style="list-style-type: none"> - This setting is switched to MOUSE while a picture input from the USB TYPE B port is projected. - The USB TYPE B port is selected as the picture input source while this setting is set to MOUSE. Select USB DISPLAY in the dialog to project the picture input to the USB TYPE B port. In this case, you cannot use the simple mouse and keyboard function. Otherwise select other port for picture input.

(continued on next page)

OPTION menu

Item	Description
LAMP TIME	<p>The lamp time is the usage time of the lamp, counted after the last resetting. It is shown in the OPTION menu.</p> <p>Pressing the RESET button on the remote control or the ► button of the projector displays a dialog.</p> <p>To reset the lamp time, select the OK using the ► button.</p> <p>CANCEL ⇨ OK</p> <ul style="list-style-type: none"> • Please reset the lamp time only when you have replaced the lamp, for a suitable indication about the lamp. • For the lamp replacement, see the section "Replacing the lamp" (85).
FILTER TIME	<p>The filter time is the usage time of the air filter, counted after the last resetting. It is shown in the OPTION menu.</p> <p>Pressing the RESET button on the remote control or the ► button of the projector displays a dialog.</p> <p>To reset the filter time, select the OK using the ► button.</p> <p>CANCEL ⇨ OK</p> <ul style="list-style-type: none"> • Please reset the filter time only when you have cleaned or replaced the air filter, for a suitable indication about the air filter. • For the air filter cleaning, see the section "Cleaning and replacing the air filter" (87, 88).

(continued on next page)

Item	Description
<p>MY BUTTON</p>	<p>This item is to assign one of the following functions to MY BUTTON 1/2 on the remote control (📖6).</p> <p>(1) Use the ▲/▼ buttons on the MY BUTTON menu to select a MY BUTTON - (1/2) and press the ► or ENTER button to display the MY BUTTON setup dialog.</p> <p>(2) Then using the ▲/▼/◀/▶ buttons sets one of the following functions to the chosen button. Press the ENTER or INPUT button to save the setting.</p> <ul style="list-style-type: none"> • LAN: Selects input from LAN port. • USB TYPE A: Selects input from USB TYPE A port. • USB TYPE B: Selects input from USB TYPE B port. • HDMI: Selects input from HDMI port. • COMPUTER IN1: Selects the input from COMPUTER IN1 port. • COMPUTER IN2: Selects the input from COMPUTER IN2 port. • COMPONENT: Selects the input from component video (Y, Cb/Pb, Cr/Pr) ports. • S-VIDEO: Selects the input from S-VIDEO port. • VIDEO: Selects the input from VIDEO port. • SLIDESHOW: Selects the input from USB TYPE A, and starts a Slideshow. • MY IMAGE: Displays the MY IMAGE menu (📖63). • MESSENGER: Turns the messenger text displayed on the screen on/off (📖Messenger Function in the Network Guide). <p>When there is no transferred text data to display, the message "NO MESSENGER DATA" appears.</p> <ul style="list-style-type: none"> • INFORMATION: Displays SYSTEM_INFORMATION, INPUT_INFORMATION (📖59), NETWORK_INFORMATION (📖66) or nothing. • AUTO KEYSTONE : Performs automatic keystone distortion correction (📖40). • MY MEMORY: Loads one of adjustment data stored (📖32). <p>When more than one data are saved, the adjustment changes every time the MY BUTTON is pressed.</p> <p>When no data is saved in memory, the dialog "No saved data" appears.</p> <p>When the current adjustment is not saved to memory, the dialog as shown in the right appears.</p> <div style="text-align: right;">  </div> <div style="text-align: right;">  </div> <p>If you want to keep the current adjustment, please press the ► button to exit. Otherwise loading a data will overwrite the current adjusted condition.</p>

(continued on next page)

OPTION menu

Item	Description
MY BUTTON (Continued)	<ul style="list-style-type: none"> • ACTIVE IRIS: Changes the active iris mode. • PICTURE MODE: Changes the PICTURE MODE (📖28). • FILTER RESET: Displays the filter time reset confirmation dialogue (📖52). • TEMPLATE: Makes the template pattern selected to the TEMPLATE item (📖48) appear or disappear. • AV MUTE: Turns the picture and audio on/off. • RESOLUTION: Turns on/off the RESOLUTION dialog (📖39). • MIC VOLUME: Turns on/off the MIC VOLUME dialog (📖43). • ECO MODE: Turns on/off the ECO MODE dialog (📖41).
MY SOURCE	<p>Using ▲/▼ buttons selects the picture input port to be selected with pressing the MY SOURCE/DOC.CAMERA button on the remote control.</p> <p>You can use this function not only for document cameras but also computers and other equipment.</p> <p>  </p>

(continued on next page)

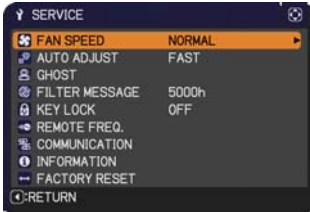
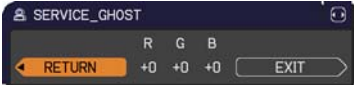
Item	Description
SERVICE	<p>Selecting this item displays the SERVICE menu.</p> <p>Select an item using the ▲/▼ buttons, and press the ► button or the ENTER button on the remote control to execute the item.</p> 
	<p>FAN SPEED</p> <p>Using the ▲/▼ buttons switches the rotation speed of the cooling fans. The HIGH is the mode for use at highlands etc. Note that the projector is noisier when the HIGH is selected.</p> <p>HIGH ⇔ NORMAL</p>
	<p>AUTO ADJUST</p> <p>Using the ▲/▼ buttons to select one of the mode. When the DISABLE is selected, the automatic adjustment feature is disabled.</p> <p>FINE ⇔ FAST ⇔ DISABLE</p> <p style="text-align: center;">↑ └──────────────────┘</p> <p><u>FINE</u>: Finer tuning including H.SIZE adjustment. <u>FAST</u>: Faster tuning, setting H.SIZE to prearranged data for the input signal.</p> <ul style="list-style-type: none"> Depending on conditions, such as input image, signal cable to the projector, environment around the projector, etc., the automatic adjustment may not work correctly. In such a case, please choose DISABLE to disable the automatic adjustment, and make adjustment manually.
	<p>GHOST</p> <ol style="list-style-type: none"> Select a color element of ghost using the ◀/▶ buttons. Adjust the selected element using the ▲/▼ buttons to disappear ghost. 
<p>FILTER MESSAGE</p> <p>Use the ▲/▼ button to set the timer for notifying by the message when to replace the filter unit</p> <p>100h ⇔ 200h ⇔ 500h ⇔ 1000h ⇔ 2000h ⇔ 5000h ⇔ OFF</p> <p>After choosing an item except OFF, the message “REMINDER *** HRS PASSED” will appear after the timer reaches the interval time set by this feature (📖92).</p> <p>When the OFF is chosen, the message will not appear. Utilize this feature to keep the air filter clean, setting the suitable time according to your environment of this projector.</p> <ul style="list-style-type: none"> Please take care of the filter unit periodically, even if there is no message. If the air filter becomes to be blocked by dust or other matter, the internal temperature will rise, which could cause malfunction, or reduce the lifetime of the projector. Please be careful with the operating environment of the projector and the condition of the filter unit. 	

(continued on next page)

OPTION menu

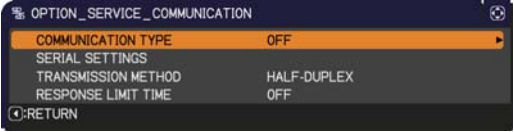

Item	Description
<p>SERVICE (continued)</p>	<p>KEY LOCK Using the ▲/▼ buttons turns on/off the key lock feature. When ON is selected, the buttons on the projector except the STANDBY/ON button are locked. ON ⇔ OFF</p> <ul style="list-style-type: none"> • Please use this function to prevent tampering or accidental operation. This function does not have any effect on the remote control. <hr/> <p>REMOTE FREQ. (1) Use the ▲/▼ button to change the projector's remote sensor frequency setting (📖4, 16). 1:NORMAL ⇔ 2:HIGH</p> <p>(2) Use the ◀/▶ button to change the projector's remote sensor on or off. ON ⇔ OFF</p> <p>The factory default setting is for both 1:NORMAL and 2:HIGH to be on. If the remote control does not function correctly, disable either of them. It's not possible to disable both options at the same time.</p>
	<p>COMMUNICATION</p> <p>Selecting this item displays COMMUNICATION menu. In this menu, you can configure the serial communication settings of the projector using the CONTROL port.</p>  <ul style="list-style-type: none"> • Select an item using the cursor buttons ▲/▼. Then pressing the ▶ button opens the submenu for the setting item you selected. Or, pressing the ◀ button instead of the ▶ button makes the menu back to the previous one without changing the setup. Each submenu can be operated as described above. • When COMMUNICATION TYPE (📖57) is set to OFF, the other items in COMMUNICATION menu are invalid. • For the function of serial communication, refer to the Network Guide.

(continued on next page)

OPTION menu

Item	Description	
<p>SERVICE (continued)</p>	<p>COMMUNICATION (continued)</p>	<p>RESPONSE LIMIT TIME Select the time period to wait for receiving response data from other device communicating by the NETWORK BRIDGE and the HALF-DUPLEX through the CONTROL port.</p> <p>OFF ⇔ 1s ⇔ 2s ⇔ 3s </p> <p><u>OFF</u>: Select this mode if it is not required to check the responses from the device that the projector sends data to. In this mode, the projector can send out data from the computer continuously.</p> <p><u>1s /2s /3s</u>: Select the time period to keep the projector waiting for response from the device that the projector sends data to. While waiting the response, the projector does not send out any data from the CONTROL port.</p> <ul style="list-style-type: none"> • This menu is available only when the NETWORK BRIDGE is selected for the COMMUNICATION TYPE and the HALF-DUPLEX is selected for the TRANSMISSION METHOD (57). • OFF is selected as the default setting.

(continued on next page)

Item	Description
<p>SERVICE (continued)</p>	<p>INFORMATION</p> <p>Selecting this item displays a dialog titled “INPUT_INFORMATION”. It shows the information about the current input.</p> <div style="display: flex; justify-content: space-around; align-items: center;">    </div> <ul style="list-style-type: none"> • The “FRAME LOCK” message on the dialog means the frame lock function is working. • The “SCART RGB” message means the COMPONENT port is working as a SCART RGB input port. Please refer to the COMPONENT item in INPUT menu (📖36). • This item can't be selected for no signal and sync out. • When the MY TEXT DISPLAY is set to ON, the MY TEXT is displayed together with the input information in the INPUT_INFORMATION box (📖59).
	<p>FACTORY RESET</p> <p>Selecting OK using the ► button performs this function. By this function, all the items in all of menus will collectively return to the initial setting. Note that the items LAMP TIME, FILTER TIME, LANGUAGE, FILTER MESSAGE, NETWORK and SECURITY settings are not reset.</p> <p>CANCEL ⇨ OK</p>

NETWORK menu

NETWORK menu

Remember that incorrect network settings on this projector may cause trouble on the network. Be sure to consult with your network administrator before connecting to an existing access point on your network. Select “NETWORK” from the main menu to access the following functions.

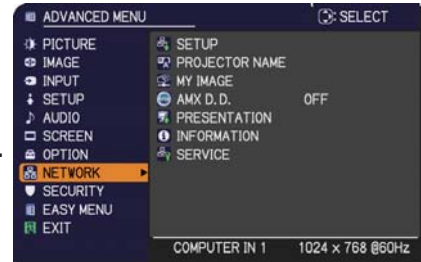

Select an item using the ▲/▼ cursor buttons on the projector or remote control, and press the ► cursor button on the projector or remote control, or **ENTER** button on the remote control to execute the item. Then perform it according to the following table.

See the **Network Guide** for details of NETWORK operation.

NOTE • If you are not utilizing SNTP (📖**Date/Time Settings** in the **Network Guide**), then you must set the DATE AND TIME during the initial installation.

- The network communication control is disabled while the projector is in standby mode if the STANDBY MODE item of SETUP menu is set to SAVING. Please connect the network communication to the projector after setting the STANDBY MODE to NORMAL (📖41).



Item	Description	
SETUP	Selecting this item displays the SETUP Menu for the network. Use the ▲/▼ buttons to select an item, and the ► or ENTER button on the remote control to perform the item. 	
	DHCP (Dynamic Host Configuration Protocol)	Use the ▲/▼ buttons to turn DHCP on/off. ON ⇔ OFF Select OFF when the network does not have DHCP enabled. <ul style="list-style-type: none"> • When the “DHCP” setting changes to “ON”, it takes a little time to obtain IP address from DHCP server. • Auto IP function will be assigned an IP address if the projector could not obtain an IP address from server even if DHCP is “ON”.

(continued on next page)



Item	Description	
SETUP (continued)	IP ADDRESS	Use the ▲/▼/◀/▶ buttons to enter the IP ADDRESS. This function can only be used when DHCP is set to OFF. <ul style="list-style-type: none"> • The IP ADDRESS is the number that identifies this projector on the network. You cannot have two devices with the same IP ADDRESS on the same network. • The IP ADDRESS “0.0.0.0” is prohibited.
	SUBNET MASK	Use the ▲/▼/◀/▶ buttons to enter the same SUBNET MASK used by your computer. This function can only be used when DHCP is set to OFF. <ul style="list-style-type: none"> • The SUBNET MASK “0.0.0.0” is prohibited.
	DEFAULT GATEWAY	Use the ▲/▼/◀/▶ buttons to enter the DEFAULT GATEWAY (a node on a computer network that serves as an access point to another network) address. This function can only be used when DHCP is set to OFF.
	DNS SERVER	Use the ▲/▼/◀/▶ buttons to input the DNS server address. The DNS server is a system to control domain names and IP addresses on the Network.
	TIME DIFFERENCE	Use the ▲/▼ buttons to enter the TIME DIFFERENCE. Set the same TIME DIFFERENCE as the one set on your computer. If unsure, consult your IT manager. Use the ▶ button to return to the menu after setting the TIME DIFFERENCE.
	DATE AND TIME	Use the ▲/▼/◀/▶ buttons to enter the Year (last two digits), Month, Date, Hour and Minute. <ul style="list-style-type: none"> • The projector will override this setting and retrieve DATE AND TIME information from the Time server when SNTP is enabled. (📖 Date/Time Settings in the Network Guide)

(continued on next page)

NETWORK menu

Item	Description
<p style="text-align: center;">PROJECTOR NAME</p>	<p>(1) Use the ▲/▼ buttons on the NETWORK menu to select the PROJECTOR NAME and press the ► button. The PROJECTOR NAME dialog will be displayed.</p>  <p>(2) The current PROJECTOR NAME will be displayed on the first 3 lines. Particular projector name is pre-assigned by default. Use the ▲/▼/◀/▶ buttons and the ENTER or INPUT button to select and enter characters. To erase 1 character at one time, press the RESET button or press the ◀ and INPUT button at the same time. Also if you move the cursor to DELETE or ALL CLEAR on screen and push the ENTER or INPUT button, 1 character or all characters will be erased. The PROJECTOR NAME can be input up to 64 characters.</p> <p>(3) To change an already inserted character, press the ▲/▼ button to move the cursor to one of the first 3 lines, and use the ◀/▶ buttons to move the cursor on the character to be changed. After pressing the ENTER or INPUT button, the character is selected. Then, follow the same procedure as described at the item (2) above.</p>   <p>(4) To finish entering text, move the cursor to the OK on screen and press the ►, ENTER or INPUT button. To revert to the previous PROJECTOR NAME without saving changes, move the cursor to the CANCEL on screen and press the ◀, ENTER or INPUT button.</p>

(continued on next page)

Item	Description
<p>MY IMAGE</p>	<p>Selecting this item displays the MY IMAGE menu.</p> <p>To store images in the projector, the application software PJImg/Projector Image Tool that can be downloaded from our website is required.</p> <p>Use the ▲/▼ buttons to select an item which is a still image by the MY IMAGE (📖 My Image Function in the Network Guide) and the ► or ENTER button to display the image.</p> <ul style="list-style-type: none"> • The item without image stored cannot be selected. • The image names are each displayed in 16 characters or less. <p>To switch the image displayed Use the ▲/▼ buttons.</p> <p>To return to the menu Press the ◀ button on the remote control.</p> <p>To erase the image displayed and its source file in the projector.</p> <p>(1) Press the RESET button on the remote control while displaying an image to display the MY IMAGE DELETE menu.</p> <p>(2) Press the ► button to perform to erase. To stop erasing, press the ◀ button.</p>  
<p>AMX D.D. (AMX Device Discovery)</p>	<p>Use the ▲/▼ buttons to turn the AMX Device Discovery on/off. ON ⇔ OFF</p> <p>When ON is selected, the projector can be detected by controllers of AMX connected to the same network. For the details of AMX Device Discovery, visit the AMX web site. <u>URL: http://www.amx.com/</u> (as of Dec.2009)</p>

(continued on next page)

NETWORK menu

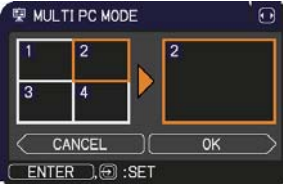
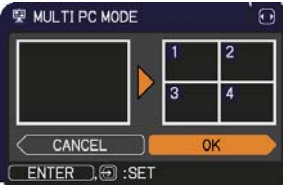

Item	Description
PRESENTATION	<p>Selecting this item displays the PRESENTATION menu. Use ▲/▼ buttons to select one of the following items, then press ► or ENTER button to use the function.</p>
	<p>QUIT PRESENTER MODE</p> <p>If you set a computer to the Presenter mode while its image is projected, the projector is occupied by the computer and access from any other computer is blocked.</p> <p>Use this function to quit the Presenter mode and allow other computers to access the projector.</p> <p>Select this item to display a dialog.</p> <p>Press ► button to choose OK in the dialog.</p> <p>The Presenter mode is cancelled and a message is displayed indicating the result.</p> <ul style="list-style-type: none"> • To make Presenter mode setting, use “LiveViewer”. <p>For details, see the section Presenter mode in the Network Guide.</p>
	<p>MULTI PC MODE</p> <p>If you set one or more computers to the Multi PC mode on “LiveViewer” and send their images to the projector, you can select the display mode on the projector from two options below.</p> <ul style="list-style-type: none"> - Single PC mode: displays the image of the selected computer on full screen. - Multi PC mode: displays the images sent from up to four computers on screen that is divided into quarter sections. <p>Select this item to display a dialog.</p> <p>Use the dialog to change the display mode as explained below.</p>

(continued on next page)

Item	Description	
<p>PRESENTATION (continued)</p>	<p>MULTI PC MODE (continued)</p>	<ul style="list-style-type: none"> • To change from Multi PC mode to Single PC mode, select one of computers in the dialog using the ▲/▼/◀/▶ buttons and press the ENTER or INPUT button. Press the ▶ button to choose OK, and then press ENTER or INPUT again. The image for the selected computer is displayed on full screen. • To change from Single PC mode to Multi PC mode, press ▶ button to choose OK in the dialog and press the ENTER or INPUT button. The display mode is changed. • For details on how to switch the display mode to Multi PC mode on your computer, see the section Switching the display mode in the Network Guide. • The Presenter mode setting of the selected computer becomes valid when the display mode is changed to Single PC mode. Also, the Presenter mode setting becomes invalid when the display mode is changed to Multi PC mode, regardless the setting on the computers. For details, see the section Presenter mode in the Network Guide.  
	<p>DISPLAY USER NAME</p>	<p>Selecting this item displays the user name. This function helps you identify from which computer the current image is sent.</p> <ul style="list-style-type: none"> • You can set user names for each computer on “LiveViwer”. <p>For details, see the section Display User Name in the Network Guide.</p>

(continued on next page)

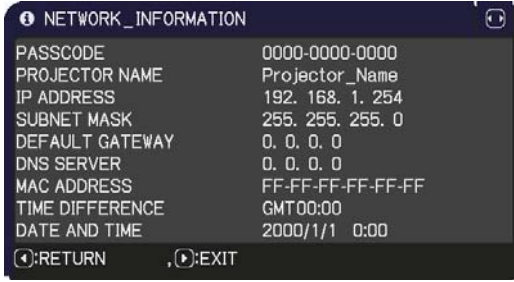
NETWORK menu

Item	Description
<p>INFORMATION</p>	<p>Selecting this item displays the NETWORK_INFORMATION dialog for confirming the network settings.</p>  <ul style="list-style-type: none"> • For the details of PASSCODE, see the section Selecting the network connection method in the User’s manual – Network Guide. • Only the first 16 characters of the projector name are displayed. • When the voltage level of the battery for the built in clock decreases, the set time may become incorrect even though accurate date and time are input. Replace the battery suitably (📖89). • IP ADDRESS, SUBNET MASK and DEFAULT GATEWAY indicate “0.0.0.0” when DHCP is ON and the projector has not gotten address from DHCP server.
<p>SERVICE</p>	<p>Executing this item restarts and initializes the network functions. Choose the RESTART EXECUTE using the button ▶.</p>  <p>Then use the button ▶ to execute.</p>  <p>Network will be once cut off when choose restart. If DHCP is selected on, IP address may be changed. After selecting RESTART EXECUTE, NETWORK menu may not be controlled approx. 30 seconds.</p>

SECURITY menu

This projector is equipped with security functions. From the SECURITY menu, items shown in the table below can be performed.

To use SECURITY menu: User registration is required before using the security functions.

Enter the SECURITY menu

1. Use the ▲/▼ buttons on the SECURITY menu to select ENTER PASSWORD and press the ► button. The ENTER PASSWORD box will be displayed.
2. Use the ▲/▼/◀/▶ buttons to enter the registered password. The factory default password is **4278**. This password can be changed (below). Move the cursor to the right side of the ENTER PASSWORD box and press the ► button to display the SECURITY menu.
 - It is strongly recommended the factory default password to be changed as soon as possible.
 - If an incorrect password is input, the ENTER PASSWORD box will be displayed again. If incorrect password is input 3 times, the projector will turn off. Afterwards the projector will turn off every time an incorrect password is input.
3. Items shown in the table below can be performed.



If you have forgotten your password

- (1). While the ENTER PASSWORD box is displayed, press and hold the **RESET** button on the remote control for about 3 seconds or press and hold the **INPUT** button for 3 seconds while pressing the ► button on the projector.
- (2). The 10 digit Inquiring Code will be displayed. Contact your dealer with the 10 digit Inquiring Code. Your password will be sent after your user registration information is confirmed.

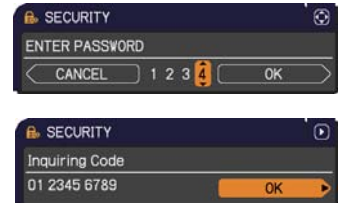



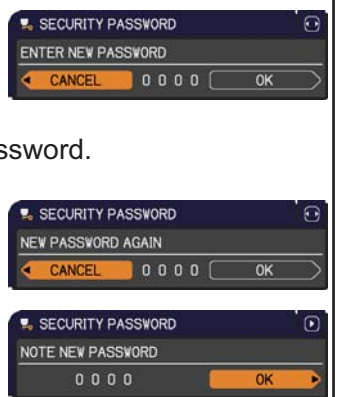

• If there is no key input for about 55 seconds while the Inquiring Code is displayed, the menu will close. If necessary, repeat the process from (1).

Item	Description
<p>SECURITY PASSWORD CHANGE</p>	<ol style="list-style-type: none"> (1) Use the ▲/▼ buttons on the SECURITY menu to select SECURITY PASSWORD CHANGE and press the ► button to display the ENTER NEW PASSWORD box. (2) Use the ▲/▼/◀/▶ buttons to enter the new password. (3) Move the cursor to the right side of the ENTER NEW PASSWORD box and press the ► button to display the NEW PASSWORD AGAIN box, enter the same password again. (4) Move the cursor to the right side of the NEW PASSWORD AGAIN box and press the ► button and the NOTE NEW PASSWORD box will be displayed for about 30 seconds, please make note of the password during this time. Pressing the ENTER button on the remote control or ► button on the projector will close the NOTE NEW PASSWORD box. <ul style="list-style-type: none"> • Please do not forget your password.

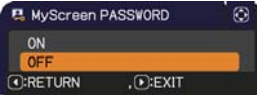

(continued on next page)

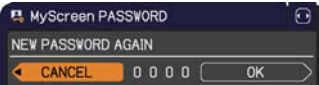
SECURITY menu

Item	Description
<p>MyScreen PASSWORD</p>	<p>The MyScreen PASSWORD function can be used to prohibit access to the MyScreen function and prevent the currently registered MyScreen image from being overwritten.</p> <p>1 Turning on the MyScreen PASSWORD</p> <p>1-1 Use the ▲/▼ buttons on the SECURITY menu to select MyScreen PASSWORD and press the ► button to display the MyScreen PASSWORD on/off menu.</p>  <p>1-2 Use the ▲/▼ buttons on the MyScreen PASSWORD on/off menu to select ON. The ENTER NEW PASSWORD box (small) will be displayed.</p>  <p style="text-align: center;">ENTER NEW PASSWORD box (small)</p> <p>1-3 Use the ▲/▼/◀/▶ buttons to enter the password. Move the cursor to the right side of the ENTER NEW PASSWORD box (small) and press the ► button to display the NEW PASSWORD AGAIN box, enter the same PASSWORD again.</p>  <p>1-4 Move the cursor to the right side of the NEW PASSWORD AGAIN box and press the ► button to display the NOTE NEW PASSWORD box for about 30 seconds, please make note of the password during this time.</p>  <p>Pressing the ENTER button on the remote control or ► button on the projector will return to MyScreen PASSWORD on/off menu.</p> <p>When a password is set for MyScreen:</p> <ul style="list-style-type: none"> • The MyScreen registration function (and menu) will be unavailable. • The MyScreen Lock menu will be unavailable. • The START UP setting will be locked on MyScreen (and the menu will be unavailable). <p>Turning the MyScreen PASSWORD off will allow normal operation of these functions.</p> <ul style="list-style-type: none"> • Please do not forget your MyScreen PASSWORD. <p>2 Turning off the MyScreen PASSWORD</p> <p>2-1 Follow the procedure in 1-1 to display the MyScreen PASSWORD on/off menu.</p> <p>2-2 Select OFF to display the ENTER PASSWORD box (large). Enter the registered password and the screen will return to the MyScreen PASSWORD on/off menu.</p>  <p style="text-align: center;">ENTER PASSWORD box (large)</p> <p>If an incorrect PASSWORD is input, the menu will close. If necessary, repeat the process from 2-1.</p> <p>3 If you have forgotten your password</p> <p>3-1 Follow the procedure in 1-1 to display the MyScreen PASSWORD on/off menu.</p> <p>3-2 Select OFF to display the ENTER PASSWORD box (large). The 10 digit Inquiring Code will be displayed inside the box.</p> <p>3-3 Contact your dealer with the 10 digit Inquiring Code. Your password will be sent after your user registration information is confirmed.</p>

(continued on next page)

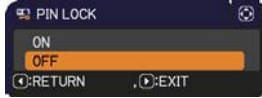
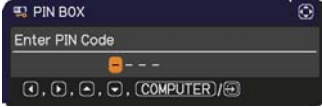
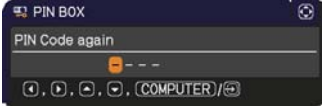
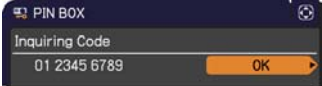
Item	Description
<p>PIN LOCK</p>	<p>PIN LOCK is a function which prevents the projector from being used unless a registered Code is input.</p> <p>1 Turning on the PIN LOCK</p> <p>1-1 Use the ▲/▼ buttons on the SECURITY menu to select PIN LOCK and press the ► button or the ENTER button to display the PIN LOCK on/off menu.</p>  <p>1-2 Use the ▲/▼ buttons on the PIN LOCK on/off menu to select ON and the Enter PIN Code box will be displayed.</p>  <p>1-3 Input a 4 part PIN code using the ▲/▼/◀/▶, COMPUTER or INPUT button. The PIN Code again box will appear. Reenter the same PIN code. This will complete the PIN code registration.</p>  <ul style="list-style-type: none"> • If there is no key input for about 55 seconds while the Enter PIN Code box or the PIN Code again box is displayed, the menu will close. If necessary, repeat the process from 1-1. <p>Afterwards, anytime the projector is restarted after AC power is turned off the Enter PIN Code box will be displayed. Enter the registered PIN code. The projector can be used after entering the registered PIN code. If an incorrect PIN code is input, the Enter PIN code box will be displayed again. If an incorrect PIN code is input 3 times, the projector will turn off. Afterwards the projector will turn off every time an incorrect PIN code is input. The projector will also turn off if there is no key input for about 5 minutes while the Enter PIN code box is displayed. This function will activate only when the projector is started after AC power is turned off.</p> <ul style="list-style-type: none"> • Please do not forget your PIN code. <p>2 Turning off the PIN LOCK</p> <p>2-1 Follow the procedure in 1-1 to display the PIN LOCK on/off menu.</p> <p>2-2 Use the ▲/▼ buttons to select OFF and the Enter PIN Code box will be displayed. Enter the registered PIN code to turn the PIN LOCK function off. If an incorrect PIN Code is input 3 times, the menu will close.</p> <p>3 If you have forgotten your PIN code</p> <p>3-1 While the Enter PIN code box is displayed, press and hold the RESET button for three seconds or press and hold the INPUT button for 3 seconds while pressing the ► button on the projector. The 10 digit Inquiring Code will be displayed.</p>  <ul style="list-style-type: none"> • If there is no key input for about 5 minutes while the Inquiring Code is displayed, the projector will turn off. <p>3-2 Contact your dealer with the 10 digit Inquiring Code. Your PIN code will be sent after your user registration information is confirmed.</p>



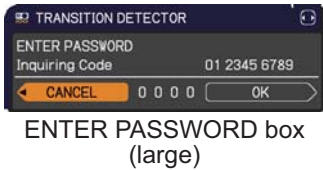
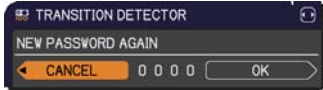
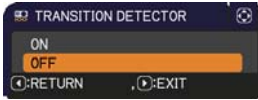

(continued on next page)

SECURITY menu

Item	Description
<p>TRANSITION DETECTOR</p>	<p>If this function is set to ON when the vertical angle of the projector or MIRROR setting at which the projector is turned on is different than the previously recorded, the TRANSITION DETECTOR ON alarm will be displayed and the projector will not display the input signal.</p> <ul style="list-style-type: none"> • To display the signal again, set this function OFF. • After about 5 minutes of displaying the TRANSITION DETECTOR ON alarm, the lamp will turn off. • Keystone adjustment feature has been prohibited as long as the Transition Detector function is on. <p>1 Turning on the TRANSITION DETECTOR</p> <p>1-1 Use the ▲/▼ buttons on the SECURITY menu to select TRANSITION DETECTOR and press the ► or the ENTER button to display the TRANSITION DETECTOR on/off menu.</p> <p>1-2 Use the ▲/▼ buttons on the TRANSITION DETECTOR on/off menu to select ON. Select ON and the current angle and MIRROR setting will be recorded. The ENTER NEW PASSWORD box (small) will be displayed.</p> <p>1-3 Use the ▲/▼/◀/▶ buttons to enter a password. Move the cursor to the right side of the ENTER NEW PASSWORD box (small) and press the ► button to display the NEW PASSWORD AGAIN box, enter the same password again.</p> <p>1-4 Move the cursor to the right side of the NEW PASSWORD AGAIN box and press the ► button to display the NOTE NEW PASSWORD box for about 30 seconds, please make note of the password during this time. Pressing the ENTER button on the remote control or the ► button on the projector will return to the TRANSITION DETECTOR on/off menu.</p> <ul style="list-style-type: none"> • Please do not forget your TRANSITION DETECTOR password. • This function will activate only when the projector is started after turning off the AC power. • This feature may not function properly if the projector is not in a stable position when ON is selected. <p>2 Turning off the TRANSITION DETECTOR</p> <p>2-1 Follow the procedure in 1-1 to display the TRANSITION DETECTOR on/off menu.</p> <p>2-2 Select OFF to display the ENTER PASSWORD box (large). Enter the registered password and the screen will return to the TRANSITION DETECTOR on/off menu.</p> <p>If an incorrect password is input, the menu will close. If necessary, repeat the process from 2-1.</p> <p>3 If you have forgotten your password</p> <p>3-1 Follow the procedure in 1-1 to display the TRANSITION DETECTOR on/off menu.</p> <p>3-2 Select OFF to display the ENTER PASSWORD box (large). The 10 digit Inquiring Code will be displayed inside the box.</p> <p>3-3 Contact your dealer with the 10 digit Inquiring Code. Your password will be sent after your user registration information is confirmed.</p>



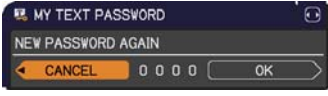



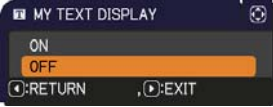

(continued on next page)

Item	Description
<p>MY TEXT PASSWORD</p>	<p>The MY TEXT PASSWORD function can prevent the MY TEXT from being overwritten. When the password is set for the MY TEXT;</p> <ul style="list-style-type: none"> • The MY TEXT DISPLAY menu will be unavailable, which can prohibit changing the DISPLAY setting. • The MY TEXT WRITING menu will be unavailable, which can prevent the MY TEXT from being overwritten. <p>1 Turning on the MY TEXT PASSWORD</p> <p>1-1 Use the ▲/▼ buttons on the SECURITY menu to select the MY TEXT PASSWORD and press the ► button to display the MY TEXT PASSWORD on/off menu.</p>  <p>1-2 Use the ▲/▼ buttons on the MY TEXT PASSWORD on/off menu to select ON. The ENTER NEW PASSWORD box (small) will be displayed.</p>  <p>ENTER NEW PASSWORD box (small)</p> <p>1-3 Use the ▲/▼/◀/▶ buttons to enter the password. Move the cursor to the right side of the ENTER NEW PASSWORD box (small) and press the ► button to display the NEW PASSWORD AGAIN box, and then enter the same password again.</p>  <p>1-4 Move the cursor to the right side of the NEW PASSWORD AGAIN box and press ► button to display the NOTE NEW PASSWORD box for about 30 seconds, then please make note of the password during this time.</p>  <p>Pressing the ENTER button on the remote control or ► button on the projector will return to the MY TEXT PASSWORD on/off menu.</p> <p>2 Turning off the MY TEXT PASSWORD</p> <p>2-1 Follow the procedure in 1-1 to display the MY TEXT PASSWORD on/off menu.</p> <p>2-2 Select OFF to display the ENTER PASSWORD box (large). Enter the registered password and the screen will return to the MY TEXT PASSWORD on/off menu.</p>  <p>ENTER PASSWORD box (large)</p> <p>If an incorrect password is input, the menu will close. If necessary, repeat the process from 2-1</p> <p>3 If you have forgotten your password</p> <p>3-1 Follow the procedure in 1-1 to display the MY TEXT PASSWORD on/off menu.</p> <p>3-2 Select OFF to display the ENTER PASSWORD box (large). The 10 digit inquiring code will be displayed inside the box.</p> <p>3-3 Contact your dealer with the 10 digit inquiring code. Your password will be sent after your user registration information is confirmed.</p>

(continued on next page)

SECURITY menu

Item	Description
<p>MY TEXT DISPLAY</p>	<p>(1) Use the ▲/▼ buttons on the SECURITY menu to select the MY TEXT DISPLAY and press the ► or ENTER button to display the MY TEXT DISPLAY on/off menu.</p>  <p>(2) Use the ▲/▼ buttons on the MY TEXT DISPLAY on/off menu to select on or off. ON ⇔ OFF</p> <p>When it is set ON, the MY TEXT will be displayed on the START UP screen and the INPUT_INFORMATION when the INFORMATION on the SERVICE menu is chosen.</p> <ul style="list-style-type: none"> • This function is available only when the MY TEXT PASSWORD function is set to the OFF.  
<p>MY TEXT WRITING</p>	<p>(1) Use the ▲/▼ buttons on the SECURITY menu to select the MY TEXT WRITING and press the ► button. The MY TEXT WRITING dialog will be displayed.</p>  <p>(2) The current MY TEXT will be displayed on the first 3 lines. If not yet written, the lines will be blank. Use the ▲/▼/◀/▶ buttons and the ENTER or INPUT button to select and enter characters. To erase 1 character at one time, press the RESET button or press the ◀ and INPUT button at the same time. Also if you move the cursor to DELETE or ALL CLEAR on screen and press the ENTER or INPUT button, 1 character or all characters will be erased. The MY TEXT can be input up to 24 characters on each line.</p>  <p>(3) To change an already inserted character, press the ▲/▼ button to move the cursor to one of the first 3 lines, and use the ◀/▶ buttons to move the cursor on the character to be changed. After pressing the ENTER or INPUT button, the character is selected. Then, follow the same procedure as described at the item (2) above.</p>  <p>(4) To finish entering text, move the cursor to the OK on screen and press the ►, ENTER or INPUT button. To revert to the previous MY TEXT without saving changes, move the cursor to the CANCEL on screen and press the ◀, ENTER or INPUT button.</p> <ul style="list-style-type: none"> • The MY TEXT WRITING function is available only when the MY TEXT PASSWORD function is set to OFF.

Presentation tools



The projector has the following two convenient tools that enable on-screen presentations easily and quickly:

- PC-LESS Presentation ( *below*)
- USB Display ( 82)

PC-LESS Presentation

The PC-LESS Presentation reads image data from storage media inserted into the **USB TYPE A** port and displays the image on the following modes.

The PC-LESS Presentation can be started by selecting the **USB TYPE A** port as the input source. This feature allows you to make your presentations without using your computer.

- Thumbnail mode ( 74)
- Full Screen mode ( 78)
- Slideshow mode ( 79)

[Supported storage media]

- USB memory (USB memory type, USB hard disk and USB card reader type)

NOTE • USB readers (adapters) that have more than one USB slot may not work (if the adapter is acknowledged as multiple devices connected).

- USB hubs may not work.
- USB devices with security software may not work.
- Be careful when inserting or removing a USB device. ( 12, 76)

[Supported format]

- FAT12, FAT16 and FAT32

NOTE • NTFS is not supported.

[Supported file format]

- JPEG (.jpeg, .jpg) * Progressive is not supported.
- Bitmap (.bmp) * 16bit mode and compressed bitmap is not supported.
- PNG (.png) * Interlace PNG is not supported.
- GIF (.gif)

NOTE • Files with a resolution greater than XGA are not supported.

- Files with a resolution smaller than 36x36 are not supported.
- Files with a resolution smaller than 100x100 may not be displayed.
- Some supported files may not be displayed.
- Only a frame appears when the content of image data cannot be displayed in the Thumbnail mode.

Presentation tools

PC-LESS Presentation (continued)**Thumbnail mode**

The Thumbnail mode displays the images stored in a USB storage device on the Thumbnail screen. Maximum 20 images are displayed in a screen.

If you wish, you can jump into the Full Screen mode or Slideshow mode, after you select some images in the Thumbnail mode.

The Thumbnail mode will be started as the primary function of the PC-LESS Presentation after selecting the **USB TYPE A** port as the input source.







PC-LESS Presentation (continued)**Operating by buttons or keys**

You can control the images in the Thumbnail screen with the remote control or keypad or a web browser software. The following functions can be supported while the Thumbnail is displayed.

Button operation			Functions
The remote control	The keypad on the projector	Web Remote in web browser software.	
▲/▼/◀/▶	▲/▼/◀/▶	UP/DOWN/LEFT/RIGHT	Move cursor
PAGE UP PAGE DOWN	-	PAGE UP PAGE DOWN	Switches pages
ENTER	INPUT	ENTER	<ul style="list-style-type: none"> • Displays the selected image on the Full Screen mode when a cursor is on a thumbnail image. • Displays the SETUP menu ( <i>next</i>) for the selected image when a cursor is on a thumbnail image number.



The SETUP menu for the selected image

Item	Functions
SETUP	Use the ◀/▶ cursor buttons to switch each setting or use the ▶ cursor button to execute the functions as follows.
RETURN	Press the ▶ cursor button or ENTER to return to the Thumbnail screen.
START	Switch to ON to set the selected image as the first image in the Slideshow. This setting information will be saved in the “playlist.txt” file ( 81).
STOP	Switch to ON to set the selected image as the last image in the Slideshow. This setting information will be saved in the “playlist.txt” file ( 81).
SKIP	Switch to ON to skip the selected image in the Slideshow. This setting information will be saved in the “playlist.txt” file ( 81).
ROTATE	Press the ▶ cursor button or ENTER to rotate the selected image 90 degrees clockwise. This setting information will be saved in the “playlist.txt” file ( 81).

Presentation tools

PC-LESS Presentation (continued)**Operating by the menu on the Thumbnail screen**

You can also control the images by using the menu on the Thumbnail screen.

Item	Functions
	Moves to an upper folder.
SORT	Allows you to sort files and folders as following.
RETURN	Press the ► cursor button or ENTER to return to the Thumbnail screen.
NAME UP	Sorts in ascending order by file name.
NAME DOWN	Sorts in descending order by file name.
DATE UP	Sorts in ascending order by file date.
DATE DOWN	Sorts in descending order by file date.
◀/▶	Go to previous / next page.
SLIDESHOW	Configures and starts the Slideshow ( 79).
RETURN	Press the ► cursor button or ENTER to return to the Thumbnail screen.
PLAY	Press the ► cursor button or ENTER to start the Slideshow.
START	Sets the beginning number of the Slideshow.
STOP	Sets the end number of the Slideshow.
INTERVAL	Sets the interval time of the Slideshow.
PLAY MODE	Selects the Slideshow mode.
INPUT	Switches the input port.
MENU	Displays the menu.
REMOVE USB	Be sure to use this function before removing USB storage device from the projector. After that, the projector will not recognize a USB storage device until you insert it again into the USB TYPE A input port.

PC-LESS Presentation (continued)

- NOTE**
- These operations are not accessible while the projector OSD is displayed.
 - The Thumbnail mode shows 20 pictures in 1 page as maximum.
 - It is not possible to change the input port by using the **INPUT** button when the Thumbnail screen, Slideshow, or Full Screen is displayed.
 - Some error icons will be displayed in the Thumbnail.



————— This file seems to be broken or not supported format.



} A file that cannot be displayed on the thumbnail screen is indicated by a file format icon.

Presentation tools

PC-LESS Presentation (continued)**Full Screen Mode**

The Full Screen mode shows a full display image. To display in Full Screen mode, select an image in the Thumbnail screen. Then press the **ENTER** button on the remote control or the **INPUT** button on the keypad, or click **[ENTER]** on the Web Remote Control.

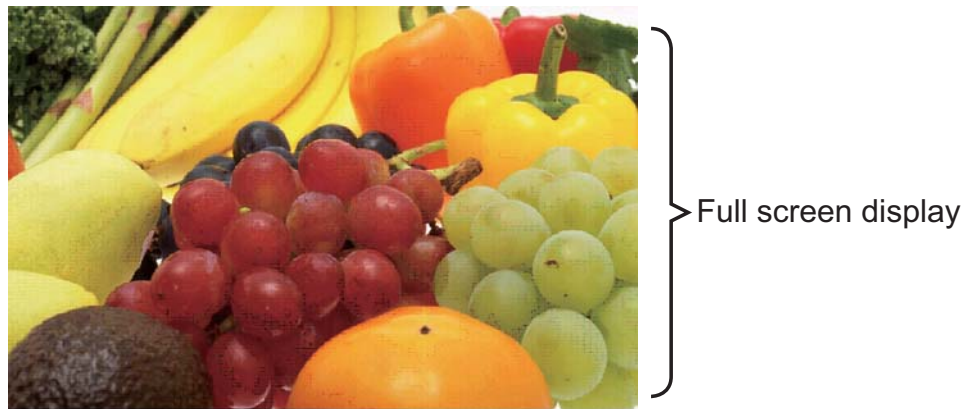

The following functions can be supported in the Full Screen mode.

Button operation			Functions
The remote control	The keypad on the projector	Web Remote in web browser software.	
▼ ▶ or PAGE DOWN	▼ or ▶	DOWN, RIGHT or PAGE DOWN	Shows the next picture.
▲ ◀ or PAGE UP	▲ or ◀	UP, LEFT or PAGE UP	Shows the previous picture.
ENTER	INPUT	ENTER	Displays Thumbnail.

NOTE • These operations are not accessible while the projector OSD is displayed.
• It is not possible to change the input port by using the **INPUT** button when the Thumbnail screen, Slideshow, or Full Screen is displayed.

PC-LESS Presentation (continued)

Slideshow mode

The Slideshow mode displays images in full screen and switches the images at intervals set in INTERVAL on the Thumbnail screen menu (74).

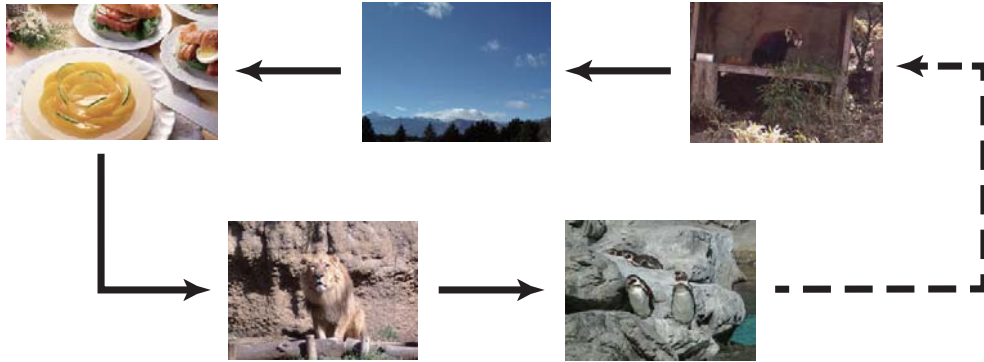

You can start this function from the Slideshow menu. To display the Slideshow menu, select the SLIDESHOW button in the Thumbnail mode and press the **ENTER** button on the remote control or **INPUT** button on the projector.

The following operations can be accessible while the Slideshow is displayed.

Button operation			Functions
The remote control	The keypad on the projector	Web Remote in web browser software.	
ENTER	INPUT	ENTER	Displays thumbnail

* These operations are not accessible while the projector OSD is displayed.

NOTE • It is not possible to change the input port by using the **INPUT** button when the Thumbnail screen, Slideshow, or Full Screen is displayed.
 • When the Slideshow mode is set to ONE TIME, the last slide of the presentation will be held on screen till the **ENTER** button on the remote control or Web Remote Control, or **INPUT** button on the projector is pushed.

Presentation tools

PC-LESS Presentation (continued)

You can play the Slideshow at your desired configuration.
Configure the Slideshow items in the Thumbnail.

- 1) RETURN : Returns to the thumbnail mode.
- 2) PLAY : Play the Slideshow.
- 3) START : Set the beginning number of the Slideshow.
- 4) STOP : Set the end number of the Slideshow.
- 5) INTERVAL : Set the interval time of the Slideshow.
It is not recommend to set the interval time very short something like several seconds, because it may take more than several seconds to read and display an image file if it is stored in very deep layer directory or if so many files are stored in the same directory.
- 6) PLAY MODE : Select the Slideshow mode.
ONE TIME : Play the Slideshow one time.
ENDLESS : Play the Slideshow endless.

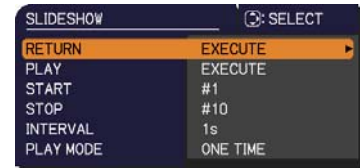

NOTE • The settings of the Slideshow are saved to the “**playlist.txt**” file that is stored in the storage media. If the file is not existed, it is generated automatically.

- The settings for the START, STOP, INTERVAL, and PLAY MODE are saved to the Playlist.
- If the storage media is under the write protection or the “**playlist.txt**” is the read only type file, it is impossible to change the settings of the Slideshow.

PC-LESS Presentation (continued)**Playlist**

The Playlist is a DOS format text file, which decides the order of displayed still image files in the Thumbnail or Slideshow.

The playlist file name is “playlist.txt” and it can be edited on a computer.

It is created in the folder that contains the selected image files when the PC-LESS Presentation is started or the Slideshow is configured.

[Example of “playlist.txt” files]

START setting : STOP setting : INTERVAL setting : PLAY MODE setting :

img001.jpg: : : :

img002.jpg:600: : :

img003.jpg:700:rot1: :

img004.jpg: : :SKIP:

img005.jpg:1000:rot2:SKIP:

The “playlist.txt” file contains the following information.

Each piece of information requires to be separated by “:”, and “.” at the end of each line.

1st line: START, STOP, INTERVAL and PLAY MODE settings ([80](#)).

2nd line and after: file name, interval time, rotation setting and skip setting.

interval time: It can be set from 0 to 999900 (ms) with an increment of 100 (ms).

rotation setting: “rot1” means a rotation at 90 degrees clockwise; “rot2” and “rot3” increase another 90 degrees in order.

skip setting: “SKIP” means that the image will not be displayed in the Slideshow.

- NOTE** • The maximum length in a line on the "playlist.txt" file is 255 characters including linefeed. If any line exceeds the limit, the "playlist.txt" file becomes invalid.
- Up to 999 files can be registered to the Playlist. However, if some folders exist in the same directory the limit number is decreased by the number of folders. Any files over the limit will not be shown in the Slideshow.
 - If the storage device is protected or does not have sufficient space, the “playlist.txt” file cannot be created.
 - For the Slideshow settings, refer to the section “**Slideshow mode**” ([79](#)).

USB Display

The projector can display images transferred from a computer via an USB cable (📖10).

Hardware and software requirement for computer

- **OS:** One of the following.
Windows® XP Home Edition /Professional Edition (32 bit version only)
Windows Vista® Home Basic /Home Premium /Business /Ultimate /Enterprise
(32 bit version only)
- **CPU:** Pentium 4 (2.8 GHz or higher)
- **Graphic card:** 16 bit, XGA or higher
- **Memory:** 512 MB or higher
- **Hard disk space:** 30 MB or higher
- **USB Port**
- **USB cable :** 1 piece

Select the USB DISPLAY for the USB TYPE B item in the OPTION menu. When you connect your computer to the **USB TYPE B** port on the projector using a USB cable, the projector will be recognized as a CD-ROM drive on your computer. Then, the software in the projector, “LiveViewerLiteUSB.exe”, will run automatically and the application, “LiveViewer Lite for USB”, will be ready on your computer for the USB Display. The application, “LiveViewer Lite for USB”, will be automatically closed when the USB cable is unplugged.

NOTE • If the software does not start automatically (this is typically because CD-ROM autorun is disabled on your OS), follow the instructions below.

(1) Click on the [Start] button on the toolbar and select the “Run”

(2) Enter F:\LiveViewerLiteUSB.exe and then press the [OK]

↑ If your CD-ROM drive is not drive F on your computer, you will need to replace F with the correct drive letter assigned to your CD-ROM drive.

- CD-ROM autorun is disabled while the screen saver is running.
- The image transmission from the computer is suspended while the password-protected screen saver is running. To resume the transmission, exit the screen saver.
- Please check and get the latest version at 3M Web site.

<http://www.3m.com/meetings>

Follow the instructions that can be obtained at the site for updating.

This application will appear in the Windows notification area once it starts. You can quit the application from your computer by selecting “Quit” on the menu.



NOTE • The “LiveViewer” (refer to the **Network Guide**) and this application cannot be used at the same time. If you connect your computer to the projector by using a USB cable while the “LiveViewer” is running, the following message will be displayed.

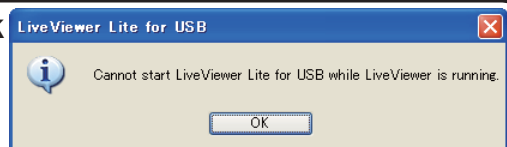

- If any application software having the firewall function is installed into your computer, make the firwall function invalid with following the user's manual.
- Some security software may block image transmission. Please change the security software setting to allow the use of "LiveViewer Lite for USB".

USB Display (continued)

Right-Click menu

The menu shown in the right will be displayed when you right-click the application icon in the Windows notification area.

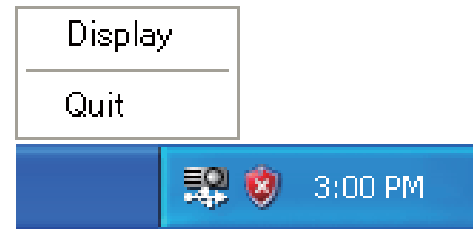

Display : The Floating menu is displayed, and the icon disappears from the Windows notification area.

Quit : The application is closed, and the icon disappears from the Windows notification area.

NOTE • If you wish to restart the application, you need to unplug the USB cable and plug it again.

Floating menu

If you select “Display” on the Right-Click menu, the Floating menu shown in the right will appear on your computer screen.

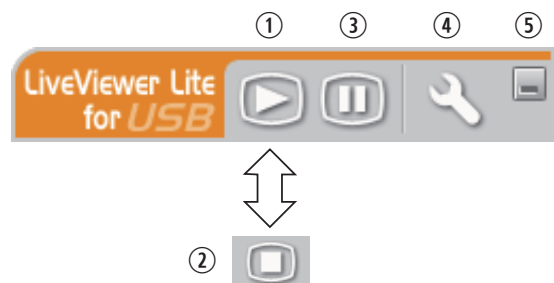

① **Start capture button**

The transmission to the projector is started and the images will be displayed.

② **Stop button**

The image transmission is stopped.

③ **Hold button**

The image on the projector’s screen is temporally frozen. The last image before the button is clicked is remained on the screen. You can revise the image data on your computer without showing it on the projector's screen.

④ **Option button**

The Options window is displayed.

⑤ **Minimize button**

The Floating menu is closed, and the icon reappears in the Windows notification area.

NOTE • If you click the Start capture button and/or Stop button repeatedly, images may not be displayed on the screen.

USB Display (continued)**Options window**

If you select the Option button on the Floating menu, the Options window is displayed.

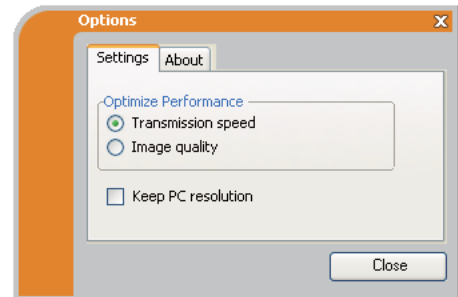
**Optimize Performance**

The “LiveViewer Lite for USB” captures screenshots in JPEG data and sends them to the projector. The “LiveViewer Lite for USB” has two options that have different compression rate of JPEG data.

Transmission speed

Speed takes priority over Image quality.

It makes JPEG compression rate higher.

The screen on the projector is rewritten quicker because the transferred data is smaller, but the image quality is worse.

Image quality

Image quality takes priority over Speed.

It makes JPEG compression rate lower.

The screen on the projector is rewritten slower because the transferred data is larger, but the image quality is better.

Keep PC resolution

If you remove the check mark from the **[Keep PC resolution]** box, the screen resolution of your computer will be switched to XGA and the display speed may be faster.

NOTE • When the resolution is changed, the arrangement of icons on computer desktop screen may be changed.

About

The version information of the “LiveViewer Lite for USB”.

Maintenance

Replacing the lamp

A lamp has finite product life. Using the lamp for long periods of time could cause the pictures darker or the color tone poor. Note that each lamp has a different lifetime, and some may burst or burn out soon after you start using them. Preparation of a new lamp and early replacement are recommended. To prepare a new lamp, make contact with your dealer and tell the lamp type number.

Type number : 78-6972-0008-3 (DT01025)

Replacing the lamp

1. Turn the projector off, and unplug the power cord.
 - Allow the projector to cool for at least 45 minutes.
2. Prepare a new lamp. If the projector is mounted on a ceiling, or if the lamp has broken, also ask the dealer to replace the lamp.

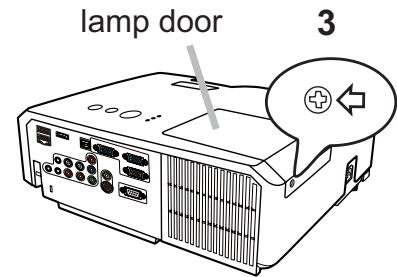

In case of replacement by yourself, follow the following procedure.

3. Loosen the screw (marked by arrow) of the lamp door and then slide and lift the lamp door to the side to remove it.
4. Loosen the 3 screws (marked by arrow) of the lamp, and slowly pick up the lamp by the handles. Never loosen any other screws.
5. Insert the new lamp, and retighten firmly the 3 screws of the lamp that are loosened in the previous process to lock it in place.
6. While putting the interlocking parts of the lamp door and the projector together, slide the lamp door back in place. Then firmly fasten the screw of the lamp door.
7. Turn the projector on and reset the lamp time using the LAMP TIME item in the OPTION menu.
 - (1) Press the **MENU** button to display a menu.
 - (2) Point at the **ADVANCED MENU** in the menu using the ▼/▲ button, then press the ► button.
 - (3) Point at the **OPTION** in the left column of the menu using the ▼/▲ button, then press the ► button.
 - (4) Point at the **LAMP TIME** using the ▼/▲ button, then press the ► button. A dialog will appear.
 - (5) Press the ► button to select "OK" on the dialog. It performs resetting the lamp time.

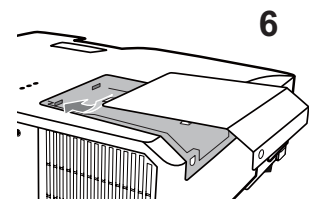
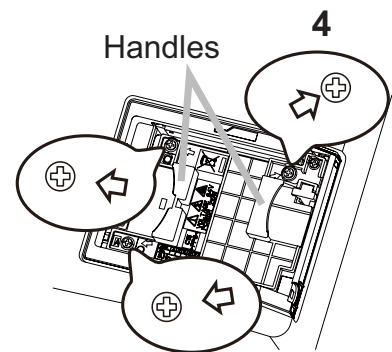
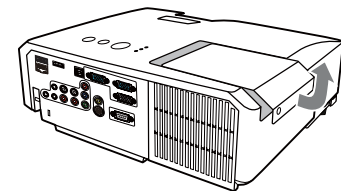

⚠ CAUTION ► Do not touch any inner space of the projector, while the lamp is taken out.

NOTE • Please reset the lamp time only when you have replaced the lamp, for a suitable indication about the lamp.

Replacing the lamp (continued)**Lamp warning****HIGH VOLTAGE****HIGH TEMPERATURE****HIGH PRESSURE**

⚠ WARNING ► The projector uses a high-pressure mercury glass lamp. The lamp can break with a loud bang, or burn out, if jolted or scratched, handled while hot, or worn over time. Note that each lamp has a different lifetime, and some may burst or burn out soon after you start using them. In addition, if the bulb bursts, it is possible for shards of glass to fly into the lamp housing, and for gas containing mercury and dust containing fine particles of glass to escape from the projector's vent holes.

► **About disposal of a lamp:** This product contains a mercury lamp; do not put it in a trash. Dispose of it in accordance with environmental laws.

- For lamp recycling, go to www.lamprecycle.org (in the US).
- For product disposal, consult your local government agency or www.eiae.org (in the US) or www.epsc.ca (in Canada).

For more information, call your dealer.



Disconnect
the plug
from the
power
outlet

- If the lamp should break (it will make a loud bang when it does), unplug the power cord from the outlet, and make sure to request a replacement lamp from your local dealer. Note that shards of glass could damage the projector's internals, or cause injury during handling, so please do not try to clean the projector or replace the lamp yourself.
- If the lamp should break (it will make a loud bang when it does), ventilate the room well, and make sure not to inhale the gas or fine particles that come out from the projector's vent holes, and not to get them into your eyes or mouth.
- Before replacing the lamp, turn the projector off and unplug the power cord, then wait at least 45 minutes for the lamp to cool sufficiently. Handling the lamp while hot can cause burns, as well as damaging the lamp.



- Never unscrew except the appointed (marked by an arrow) screws.
- Do not open the lamp door while the projector is suspended from a ceiling. This is dangerous, since if the lamp's bulb has broken, the shards will fall out when the cover is opened. In addition, working in high places is dangerous, so ask your local dealer to have the lamp replaced even if the bulb is not broken.
- Do not use the projector with the lamp door removed. At the lamp replacing, make sure that the screws are screwed in firmly. Loose screws could result in damage or injury.



- Use only the lamp of the specified type. Use of a lamp that does not meet the lamp specifications for this model could cause a fire, damage or shorten the life of this product.
- If the lamp breaks soon after the first time it is used, it is possible that there are electrical problems elsewhere besides the lamp. If this happens, consult your local dealer or a service representative.
- Handle with care: jolting or scratching could cause the lamp bulb to burst during use.
- Using the lamp for long periods of time, could cause it dark, not to light up or to burst. When the pictures appear dark, or when the color tone is poor, please replace the lamp as soon as possible. Do not use old (used) lamps; this is a cause of breakage.

Cleaning and replacing the air filter

The air filter unit of this projector consists of a filter cover, two kinds of filters, and a filter frame. The new double large filters system is expected to function longer. However, please check and clean it periodically to keep ventilation needed for normal operation of the projector.

When the indicators or a message prompts you to clean the air filter, comply with it as soon as possible. Replace the filters when they are damaged or too soiled. To prepare new filters, make contact with your dealer and tell the following type number.

Type number : 78-8138-1041-9 (MU06481(Filter set))

When you replace the lamp, please replace the air filter. An air filter of specified type will come together with a replacement lamp for this projector.

1. Turn the projector off, and unplug the power cord.
Allow the projector to sufficiently cool down.
2. Use a vacuum cleaner on and around the filter cover.
3. While supporting the projector with one hand, use your other hand to pull the filter cover forward in the direction of the arrow.
4. Use a vacuum cleaner for the filter vent of the projector and the outer side of the filter unit.
5. Take the filters out while holding the filter cover.
6. Use a vacuum cleaner on both sides of the filters.
When vacuuming up the fine meshed filter, hold it so it will not be sucked in. If the filters are damaged or heavily soiled, replace them with the new ones.
7. Put the filters back into the filter cover.
Put the coarse meshed filter into a filter cover first. Then put the fine meshed filter on the coarse meshed one, turning its stitched side up.
8. Put the filter unit back into the projector.

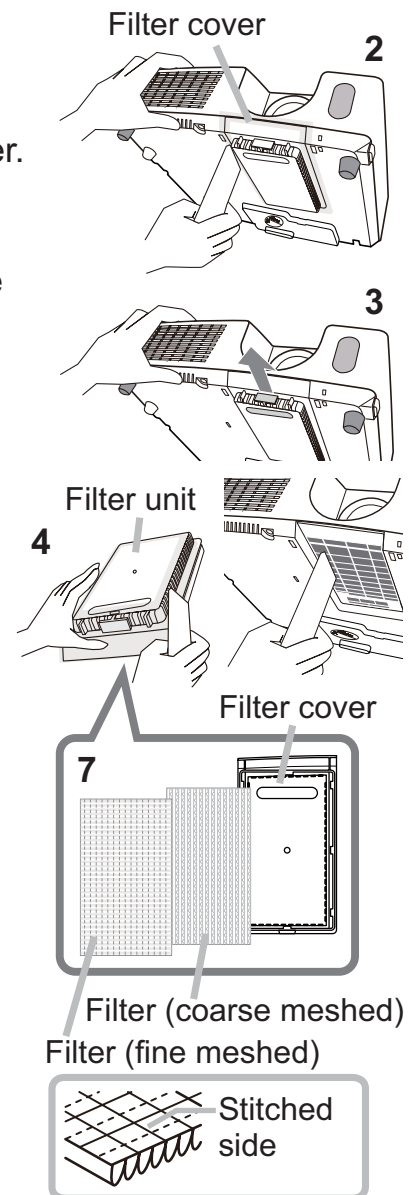

(continued on next page)

Maintenance***Cleaning and replacing the air filter (continued)***

9. Turn the projector on and reset the filter time using the FILTER TIME item in the EASY MENU.
 - (1) Press the **MENU** button to display a menu.
 - (2) Point at the FILTER TIME using the ▼/▲ button, then press the ► button. A dialog will appear.
 - (3) Press the ► button to select “OK” on the dialog. It performs resetting the filter time.

⚠ WARNING ► Before taking care of the air filter, make sure the power cable is not plugged in, then allow the projector to cool sufficiently. Taking care of the air filter in a high temperature state of the projector could cause an electric shock, a burn or malfunction to the projector.

► Use only the air filter of the specified type. Do not use the projector without the air filter or the filter cover. It could result in a fire or malfunction to the projector.

► Clean the air filter periodically. If the air filter becomes clogged by dust or the like, internal temperatures rise and could cause a fire, a burn or malfunction to the projector.

- NOTE**
- Please replace the air filter when it is damaged or heavily soiled.
 - When you replace the projection lamp, please replace the air filter. An air filter of specified type will come together with a replacement lamp for this projector.
 - Please reset the filter time only when you have cleaned or replaced the air filter, for a suitable indication about the air filter.
 - The projector may display the message such as “CHECK THE AIR FLOW” or turn off the projector, to prevent the internal heat level rising.

Replacing the internal clock battery

This projector has internal clock that uses a battery. When the clock of the network function does not work correctly, please try solution by replacement of the battery:

HITACHI MAXELL, part number **CR2032** or **CR2032H**.

1. Turn the projector off, and unplug the power cord. Allow the projector to cool sufficiently.
2. After making sure that the projector has cooled adequately, slowly turn over the projector, so that the bottom is facing.
3. Turn the battery cover fully in the direction indicated "OPEN" using a coin or the like, and pick the cover up to remove it.
4. Pry up the battery using a flathead screwdriver or the like to take it out. While prying it up, put a finger lightly on the battery since it may pop out of the holder.
5. Replace the battery with a new **HITACHI MAXELL**, Part No. **CR2032** or **CR2032H**. Slide the battery in under the plastic claw, and push it into the holder until it clicks.
6. Replace the battery cover in place, then turn it in the direction indicated "CLOSE" using such as coins, to fix.

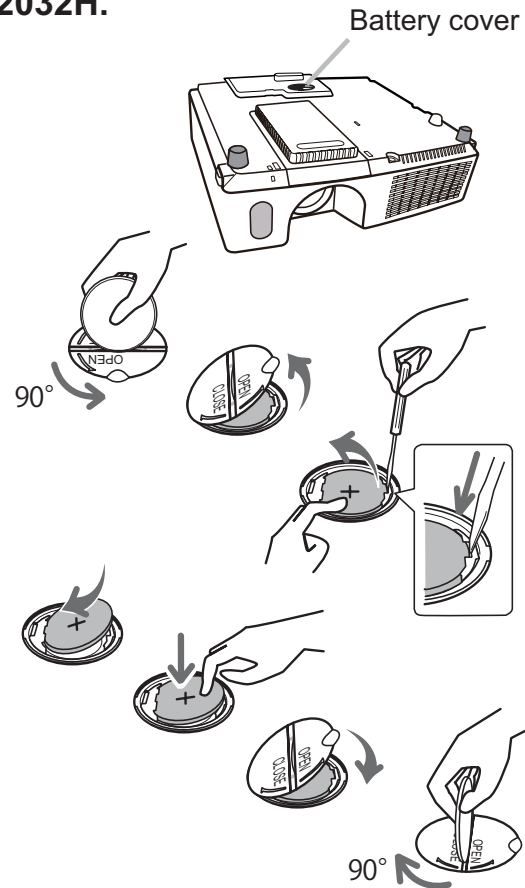

NOTE • The internal clock will be initialized by removing the battery. For setting the clock, see the **Network Guide**.

⚠ WARNING ► Be careful of handling a battery, as a battery can cause explosion, cracking or leakage, which could result in a fire, an injury, and environment pollution.

- Use only the specified and perfect battery. Do not use a battery with damage, such as a scratch, a dent, rust or leakage.
- When replacing the battery, replace it with a new battery.
- When a battery leaked, wipe the leakage out well with a waste cloth. If the leakage adhered to your body, immediately rinse it well with water. When a battery leaked in the battery holder, replace the batteries after wiping the leakage out.
- Make sure the plus and minus terminals are correctly aligned when loading a battery.
- Do not work on a battery; for example recharging or soldering.
- Keep a battery in a dark, cool and dry place. Never expose a battery to a fire or water.
- Keep a battery away from children and pets. Be careful for them not to swallow a battery. If swallowed consult a physician immediately for emergency treatment.
- Obey the local laws on disposing a battery.

Other care

Inside of the projector

In order to ensure the safe use of your projector, please have it cleaned and inspected by your dealer about once every year.

Caring for the lens

If the lens is flawed, soiled or fogged, it could cause deterioration of display quality. Please take care of the lens, being cautious of handling.

1. Turn the projector off, and unplug the power cord. Allow the projector to cool sufficiently.
2. After making sure that the projector is cool adequately, lightly wipe the lens with a commercially available lens-cleaning wipe. Do not touch the lens directly with your hand.

Caring for the cabinet and remote control

Incorrect care could have adverse influence such as discoloration, peeling paint, etc.

1. Turn the projector off, and unplug the power cord. Allow the projector to cool sufficiently.
2. After making sure that the projector is cool adequately, lightly wipe with gauze or a soft cloth.
If the projector is extremely dirty, dip soft cloth in water or a neutral cleaner diluted in water, and wipe lightly after wringing well. Then, wipe lightly with a soft, dry cloth.

⚠ WARNING ▶ Before caring, make sure the power cord is not plugged in, and then allow the projector to cool sufficiently. The care in a high temperature state of the projector could cause a burn and/or malfunction to the projector.

▶ Never try to care for the inside of the projector personally. Doing is so dangerous.

▶ Avoid wetting the projector or inserting liquids in the projector. It could result in a fire, an electric shock, and/or malfunction to the projector.

- Do not put anything containing water, cleaners or chemicals near the projector.
- Do not use aerosols or sprays.

⚠ CAUTION ▶ Please take right care of the projector according to the following. Incorrect care could cause not only an injury but adverse influence such as discoloration, peeling paint, etc.

▶ Do not use cleaners or chemicals other than those specified in this manual.

▶ Do not polish or wipe with hard objects.

NOTICE ▶ Do not directly touch the lens surface with hands.

Troubleshooting

If an abnormal operation should occur, stop using the projector immediately.





⚠ WARNING ▶ Never use the projector if abnormal operations such as smoke, strange odor, excessive sound, damaged casing or elements or cables, penetration of liquids or foreign matter, etc. should occur. In such cases, immediately disconnect the power plug from the power outlet. After making sure that the smoke or odor has stopped, contact to your dealer or service company.

Otherwise if a problem occurs with the projector, the following checks and measures are recommended before requesting repair.

If this does not resolve the problem, please contact your dealer or service company. They will tell you what warranty condition is applied.

Related messages

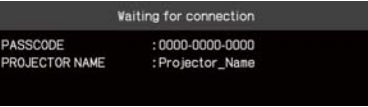



When some message appears, check and cope with it according to the following table. Although these messages will be automatically disappeared around several minutes, it will be reappeared every time the power is turned on.

Message	Description
	<p>There is no input signal. Please confirm the signal input connection, and the status of the signal source.</p>
	<p>The USB TYPE B port is selected as the picture input source even if MOUSE is selected for USB TYPE B (51). Select USB DISPLAY in the dialog to project the picture input to the USB TYPE B port. In this case, you cannot use the simple mouse and keyboard function. Otherwise select other port for picture input.</p>
	<p>Projector is waiting for an image file. Check the hardware connection, settings on the projector and network-related settings.</p>
	<p>The computer-Projector network connection might be disconnected. Please re-connect using “Connect button” of the “LiveViewer”. (Using the “LiveViewer” in the Network Guide)</p>
	<p>The horizontal or vertical frequency of the input signal is not within the specified range. Please confirm the specs for your projector or the signal source specs.</p>
	<p>An improper signal is input. Please confirm the specs for your projector or the signal source specs.</p>

(continued on next page)

Troubleshooting

Related messages (continued)

Message	Description
 <p>CHECK THE AIR FLOW</p>	<p>The internal temperature is rising. Please turn the power off, and allow the projector to cool down at least 20 minutes. After having confirmed the following items, please turn the power ON again.</p> <ul style="list-style-type: none"> • Is there blockage of the air passage aperture? • Is the air filter dirty? • Does the peripheral temperature exceed 35°C? <p>If the same indication is displayed after the remedy, please set FAN SPEED of the SERVICE item in the OPTION menu to HIGH.</p>
 <p>REMINDER 4000 HRS PASSED AFTER THE LAST FILTER CHECK. FILTER MAINTENANCE IS ESSENTIAL. TO REMOVE WARNING MESSAGE, RESET FILTER TIME. SEE MANUAL FOR FURTHER INFO.</p>	<p>A note of precaution when cleaning the air filter. Please immediately turn the power off, and clean or change the air filter referring to the “Cleaning and replacing the air filter” section of this manual. After you have cleaned or changed the air filter, please be sure to reset the filter timer ( 52,87).</p>
 <p>NOT AVAILABLE</p>	<p>The button operation is not available.</p>

Regarding the indicator lamps

When operation of the **LAMP**, **TEMP** and **POWER** indicators differs from usual, check and cope with it according to the following table.

POWER indicator	LAMP indicator	TEMP indicator	Description
Lighting In Orange	Turned off	Turned off	The projector is in a standby state. Please refer to the section “Power on/off”.
<i>Blinking</i> In Green	Turned off	Turned off	The projector is warming up. Please wait.
Lighting In Green	Turned off	Turned off	The projector is in an on state. Ordinary operations may be performed.
<i>Blinking</i> In Orange	Turned off	Turned off	The projector is cooling down. Please wait.
<i>Blinking</i> In Red	(discre- tionary)	(discre- tionary)	The projector is cooling down. A certain error has been detected. Please wait until POWER indicator finishes blinking, and then perform the proper measure using the item descriptions below.
<i>Blinking</i> In Red or Lighting In Red	Lighting In Red	Turned off	The lamp does not light, and there is a possibility that interior portion has become heated. Please turn the power off, and allow the projector to cool down at least 20 minutes. After the projector has sufficiently cooled down, please make confirmation of the following items, and then turn the power on again. <ul style="list-style-type: none"> • Is there blockage of the air passage aperture? • Is the air filter dirty? • Does the peripheral temperature exceed 35°C? If the same indication is displayed after the remedy, please change the lamp referring to the section “Replacing the lamp”.
<i>Blinking</i> In Red or Lighting In Red	<i>Blinking</i> In Red	Turned off	The lamp door has not been properly fixed. Please turn the power off, and allow the projector to cool down at least 45 minutes. After the projector has sufficiently cooled down, please make confirmation of the attachment state of the lamp door. After performing any needed maintenance, turn the power on again. If the same indication is displayed after the remedy, please contact your dealer or service company.
<i>Blinking</i> In Red or Lighting In Red	Turned off	<i>Blinking</i> In Red	The cooling fan is not operating. Please turn the power off, and allow the projector to cool down at least 20 minutes. After the projector has sufficiently cooled down, please make confirmation that no foreign matter has become caught in the fan, etc., and then turn the power on again. If the same indication is displayed after the remedy, please contact your dealer or service company.

(Continued on next page)

Troubleshooting

Regarding the indicator lamps (continued)

POWER indicator	LAMP indicator	TEMP indicator	Description
Blinking In Red or Lighting In Red	Turned off	Lighting In Red	<p>There is a possibility that the interior portion has become heated.</p> <p>Please turn the power off, and allow the projector to cool down at least 20 minutes. After the projector has sufficiently cooled down, please make confirmation of the following items, and then turn the power on again.</p> <ul style="list-style-type: none"> • Is there blockage of the air passage aperture? • Is the air filter dirty? • Does the peripheral temperature exceed 35°C? <p>If the same indication is displayed after the remedy, please set FAN SPEED of SERVICE item in OPTION menu to HIGH (📖55).</p>
Lighting In Green	Simultaneous blinking in Red		<p>It is time to clean the air filter.</p> <p>Please immediately turn the power off, and clean or change the air filter referring to the section “Cleaning and replacing the air filter”. After cleaning or changing the air filter, please be sure to reset the filter timer. After the remedy, reset the power to ON.</p>
Lighting In Green	Alternative blinking in Red		<p>There is a possibility that the interior portion has become overcooled.</p> <p>Please use the unit within the usage temperature parameters (5°C to 35°C). After the treatment, reset the power to ON.</p>
Blinking In Green for approx. 3 seconds.	Turned off	Turned off	<p>At least 1 Power ON schedule is saved to the projector.</p> <p>Please refer to Schedule Settings section of Network Guide.</p>

NOTE • When the interior portion has become overheated, for safety purposes, the projector is automatically shut down, and the indicator lamps may also be turned off. In such a case, disconnect the power cord, and wait at least 45 minutes. After the projector has sufficiently cooled down, please make confirmation of the attachment state of the lamp and lamp door, and then turn the power on again.

Shutting the projector down

Only when the projector can not be turned off by usual procedure (📖17), please push the shutdown switch using a pin or similar, and disconnect the power plug from the power outlet. Before turning it on again, wait at least 10 minutes to make the projector cool down enough.

Shutdown switch

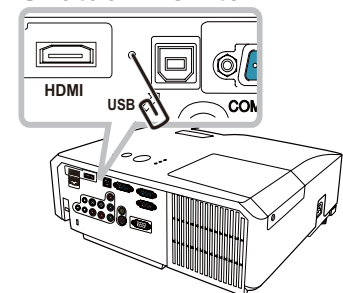

Resetting all settings

When it is hard to correct some wrong settings, the FACTORY RESET function of SERVICE item in OPTION menu (📖59) can reset all settings (except settings such as LANGUAGE, LAMP TIME, FILTER TIME, FILTER MESSAGE, SECURITY and NETWORK) to the factory default.

Phenomena that may be easy to be mistaken for machine defects

About the phenomenon confused with a machine defect, check and cope with it according to the following table.

Phenomenon	Cases not involving a machine defect	Reference page
Power does not come on.	The electrical power cord is not plugged in. Correctly connect the power cord.	14
	The main power source has been interrupted during operation such as by a power outage (blackout), etc. Please disconnect the power plug from the power outlet, and allow the projector to cool down at least 10 minutes, then turn the power on again.	12, 17
	Either there is no lamp and/or lamp door, or either of these has not been properly fixed. Please turn the power off and disconnect the power plug from the power outlet, and allow the projector to cool down at least 45 minutes. After the projector has sufficiently cooled down, please make confirmation of the attachment state of the lamp and lamp door, and then turn the power on again.	85
Neither sounds nor pictures are outputted.	The signal cables are not correctly connected. Correctly connect the connection cables.	9 ~ 13
	Signal source does not correctly work. Correctly set up the signal source device by referring to the manual of the source device.	—
	The input changeover settings are mismatched. Select the input signal, and correct the settings.	18 ~ 20
	The BLANK function for pictures and the MUTE function for sounds are working. AV MUTE may be active. Refer to the item “Sound does not come out” and “No pictures are displayed” on the next page to turn off the MUTE and BLANK functions.	18, 25, 54

(Continued on next page)

Troubleshooting

Phenomena that may be easy to be mistaken for machine defects (continued)

Phenomenon	Cases not involving a machine defect	Reference page
Sound does not come out.	The signal cables are not correctly connected. Correctly connect the audio cables.	9 ~ 13
	The MUTE function is working. Restore the sound pressing MUTE or VOLUME +/- button on the remote control.	18
	The volume is adjusted to an extremely low level. Adjust the volume to a higher level using the menu function or the remote control.	18, 42, 43
	The AUDIO SOURCE/SPEAKER setting is not correct. Correctly set the AUDIO SOURCE/SPEAKER in AUDIO menu.	42
	The mode selected for HDMI AUDIO is not suitable. Check each of the two modes provided and select the suitable one for your HDMI audio device.	43
No pictures are displayed.	The lens cover is attached. Remove the lens cover.	17
	The signal cables are not correctly connected. Correctly connect the connection cables.	9 ~ 13
	The brightness is adjusted to an extremely low level. Adjust BRIGHTNESS to a higher level using the menu function.	30
	The computer cannot detect the projector as a plug and play monitor. Make sure that the computer can detect a plug and play monitor using another plug and play monitor.	9
	The BLANK screen is displayed. Press BLANK button on the remote control.	25
	The USB TYPE B port is selected as the picture input source even if MOUSE is selected for USB TYPE B. Select USB DISPLAY for USB TYPE B in OPTION menu to project the picture input to the port. Otherwise select other port for picture input.	51
	The projector does not recognize the USB storage device inserted into USB TYPE A port. Use the REMOVE USB function first, remove the USB storage device, and then insert it into the port again. Before removing the USB storage device, be sure to use the REMOVE USB function on the thumbnail screen, which appears when the USB TYPE A port is selected as the input source.	12

(continued on next page)

Phenomena that may be easy to be mistaken for machine defects (continued)

Phenomenon	Cases not involving a machine defect	Reference page
Video screen display freezes.	The FREEZE function is working. Press FREEZE button to restore the screen to normal.	25
Colors have a faded- out appearance, or Color tone is poor.	Color settings are not correctly adjusted. Perform picture adjustments by changing the COLOR TEMP, COLOR, TINT and/or COLOR SPACE settings, using the menu functions.	31, 36
	COLOR SPACE setting is not suitable. Change the COLOR SPACE setting to AUTO, RGB, SMPTE240, REC709 or REC601.	36
Pictures appear dark.	The brightness and/or contrast are adjusted to an extremely low level. Adjust BRIGHTNESS and/or CONTRAST settings to a higher level using the menu function.	30
	The projector is operating in Eco mode. Set ECO MODE to NORMAL, and set AUTO ECO MODE to OFF, in the SETUP menu.	40, 41
	The lamp is approaching the end of its product lifetime. Replace the lamp.	85, 86
Pictures appear blurry.	Either the focus and/or horizontal phase settings are not properly adjusted. Adjust the focus using the focus ring, and/or H PHASE using the menu function.	21, 35
	The lens is dirty or misty. Clean the lens referring to the section “Caring for the lens”.	90
Some kind of image degradation such as flickering or stripes appear on screen.	When the projector is operating in Eco mode, flickering may appear on screen. Set ECO MODE to NORMAL, and set AUTO ECO MODE to OFF, in the SETUP menu.	40, 41
	The OVER SCAN ratio is too big. Adjust OVER SCAN in the IMAGE menu smaller.	33
	Excessive VIDEO NR. Change the setting of VIDEO NR in the INPUT menu.	36
	The FRAME LOCK function cannot work on the current input signal. Set FRAME LOCK in the INPUT menu to OFF.	38

(continued on next page)

Troubleshooting

Phenomena that may be easy to be mistaken for machine defects (continued)

Phenomenon	Cases not involving a machine defect	Reference page
The computer connected to the USB TYPE B port of the projector does not start up.	The computer cannot start up in the current hardware configuration. Disconnect the USB cable from the computer, then reconnect it after starting up the computer.	10
RS-232C does not work.	The SAVING function is working. Select NORMAL for STANDBY MODE item in the SETUP menu.	41
	The COMMUNICATION TYPE for the CONTROL port is set to NETWORK BRIDGE. Select OFF for COMMUNICATION TYPE item in the OPTION - SERVICE - COMMUNICATION menu.	57
Network does not work	The SAVING function is working. Select NORMAL for STANDBY MODE item in the SETUP menu.	41
NETWORK BRIDGE function does not work	The NETWORK BRIDGE function is turned off. Select NETWORK BRIDGE for COMMUNICATION TYPE item in the OPTION - SERVICE - COMMUNICATION menu.	57
Schedule function does not work	The SAVING function is working. Select NORMAL for STANDBY MODE item in the SETUP menu.	41
When the projector is connected to the network, it powers off and on as described below. Powers off ← ↓ POWER indicator blinks in orange a few times ↓ Goes into standby mode	Disconnect the LAN cable and check that the projector is working properly. If this phenomenon occurs after connecting to the network, there may be a loop between two Ethernet switching hubs within the network, as explained below. - There are two or more Ethernet switching hubs in a network. - Two of the hubs are doubly connected by LAN cables. - This double connection forms a loop between the two hubs. Such a loop may have an adverse effect on the projector as well as the other network devices. Check the network connection and remove the loop by disconnecting the LAN cables such that there is only one connecting cable between two hubs.	—
Video files cannot be played properly on a computer on which the "LiveViewer" was run.	The "LiveViewer" has been intentionally or accidentally forced to shut down. DirectDraw® or Direct3D® has been disabled on your Windows®. Please refer to the Microsoft® Help and Support home page on how to enable DirectDraw® or Direct3D®.	—

NOTE • Although bright spots or dark spots may appear on the screen, this is a unique characteristic of liquid crystal displays, and it does not constitute or imply a machine defect.

Specifications

Item	Specification
Product name	Liquid crystal projector
Liquid Crystal Panel	1,024,000 pixels (1280 horizontal x 800 vertical)
Lamp	210 W UHP
Speaker	16 W mono (8 W x 2)
Power supply/Rated current	AC 100-120 V/ 3.4 A, AC220-240 V/ 1.8 A
Power consumption	AC 100-120 V: 330 W, AC220-240 V: 310 W
Temperature range	5 ~ 35°C (Operating)
Size	317 (W) x 98 (H) x 288 (D) mm * Not including protruding parts. Please refer to the following figure.
Weight (mass)	approx. 3.6kg
Ports	<p>Computer input port COMPUTER IN1D-sub 15 pin mini x1 COMPUTER IN2D-sub 15 pin mini x1</p> <p>HDMI input port HDMIHDMI connector x1</p> <p>Computer output port MONITOR OUTD-sub 15 pin mini x1</p> <p>Video input port Y, Cb/Pb, Cr/Pr (Component video) RCA x3 S-VIDEO mini DIN 4 pin x1 VIDEO RCA x1</p> <p>Audio input/output port AUDIO IN1Stereo mini x1 AUDIO IN2Stereo mini x1 AUDIO IN3 (R, L) RCA x2 AUDIO OUT (R, L) RCA x2</p> <p>Others USB TYPE A USB-A x1 USB TYPE B USB-B x1 CONTROL D-sub 9 pin x1 LAN RJ45 x1 MIC Mono mini x1</p>

Specifications

Specifications (continued)

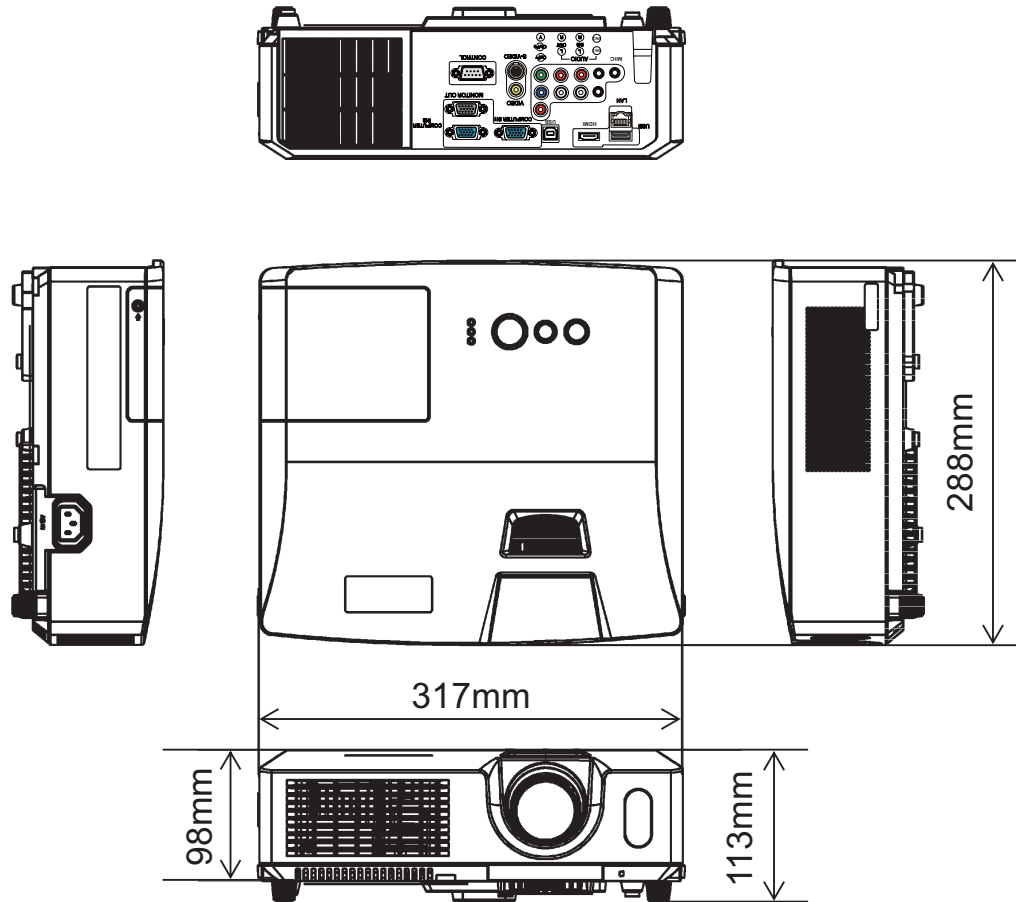

[unit: mm]

End User License Agreement for the Projector Software

- Software in the projector consists of the plural number of independent software modules and there exist our copyright or/and third party copyrights for each of such software modules.
- Be sure to read “End User license Agreement for the Projector Software” which is separated document. (in the CD)

Important Notice

All statements, technical information, and recommendations related to 3M's products are based on information believed to be reliable, but the accuracy or completeness is not guaranteed. Before using this product, you must evaluate it and determine if it is suitable for your intended application. You assume all risks and liability associated with such use. Any statements related to the product which are not contained in 3M's current publication, or any contrary statements contained on your purchase order shall have no force or effect unless expressly agreed upon, in writing, by an authorized officer of 3M.

Warranty

3M warrants that when the 3M Product is used according to 3M's Intended Use Statement (www.3m.com/meetings), it will perform satisfactorily for the warranted durability period as stated in the applicable 3M Product Manual in effect at the time of purchase. The warranties stated in the applicable 3M Product Manuals are exclusive and are made in place of any and all express or implied warranties or conditions, including any implied warranty of merchantability or fitness for a particular purpose, or any industry practice or custom or trade usage.

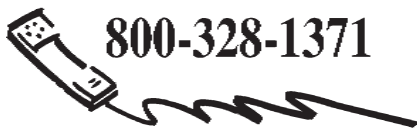

<http://www.3m.com/meetings>
e-mail: meetings@mmm.com

3M Austin Center
Building A147-5N-01
6801 River Place Blvd.
Austin, TX 78726-9000

3M Canada
P.O. Box 5757
London, Ontario
N6A 4T1

3M Mexico, S.A. de C.V.
Apartado Postal 14-139
Mexico, D.F. 07000
Mexico

3M Europe
Boulevard de l'Oise
95006 Cergy Pontoise Cedex
France

Litho in China
© 3M 2010. All Rights Reserved.
78-6971-1550-5 Rev. A