



Super Close Projection System SCP725

Operator's Guide



Contents

Introduction

Thank You for Choosing 3M Equipment	5
Trademarks	5
Important Notice	5
Warranty; Limited Remedy; Limited Liability	5
Product Patents	7
Regulatory Notices	7

Safety Information

Intended Use	9
Safety Labels	12

Contents of Shipping Box

Keep Your Packing Materials	13
What's Next?	13

Product Description

Machine Characteristics	14
Dimensions	14
Projector Distance from Screen and Image Size	15
Vertical Lens Shift	15
Parts Identification	16
Projector Terminal Connections	16
I/O Module Control Panel (optional accessory)	17
Top Terminal Panel on I/O Module	17
Bottom Terminal Panel on I/O Module	18
Remote Control Functions	19
Installing Batteries in Remote Control	20
Setup and System Configuration	20

Operating Instructions

Projector Start Up	21
Stand By Mode	21

Menu Navigation

Main Menu.....	22
Input Menu.....	23
Picture Menu.....	24
Advanced Picture Menu	25
Audio Menu	26
Setup Menu.....	27
Advanced Setup Menu.....	28
Information Menu.....	29

Machine Specifications**Maintenance**

Lamp Replacement	31
Cleaning the Air Vents.....	32
Cleaning the Lamp Module and Lamp Compartment.....	33

Troubleshooting

Identifying an Expired Lamp Module.....	35
I/O Module Troubleshooting	36
Projector Troubleshooting	36
Projector Indicator Lights.....	39
I/O Module Indicator Lights.....	39

Replacement Parts and Accessories

Replacement Parts	40
Optional Accessories (not shown).....	40

Introduction

Thank You for Choosing 3M Equipment

This product has been produced in accordance with 3M's quality and safety standards to provide smooth and trouble free use in the years to come. For optimum performance, please follow the operating instructions carefully. We hope you will enjoy using this high performance product in your classroom, meetings, presentations, and training sessions. This product is Class A and can not be sold into the home market.

Trademarks

The 3M logo and 3M are registered trademarks of 3M Company. Vikuiti is a trademark of 3M Company. Digital Light Processing is a trademark or registered trademark of Texas Instruments. All other trademarks or registered trademarks are property of their respective companies. HDMI, the HDMI Logo and High-Definition Multimedia Interface are trademarks or registered trademarks of HDMI Licensing LLC.

Important Notice

All statements, technical information, and recommendations related to 3M's products are based on information believed to be reliable, but the accuracy or completeness is not guaranteed. Before using this product, you must evaluate it and determine if it is suitable for your intended application. You assume all risks and liability associated with such use. Any statements related to the product which are not contained in 3M's current publications, or any contrary statements contained on your purchase order shall have no force or effect unless expressly set forth in a written agreement signed by an authorized officer of 3M.

Warranty; Limited Remedy; Limited Liability

This warranty applies to the continental US only. The warranty terms, conditions, remedy and limitation may vary in other countries. Contact your local 3M Company for warranty information.

The 3M SCP700 Series projector (the "3M Product") is warranted to be free from defects in material or manufacture for a period of three (3) years from the date of purchase or 4,000 hours of usage, whichever occurs first.

All other accessories of the 3M Product (those in the applicable modular configurations), excluding the projector lamps, but including the wall mounts, ceiling mounts, digital annotation sensors, and input/output devices are warranted to be free from defects in material or manufacture for a period of one (1) year from the date of purchase.

The lamp component of the 3M Product is warranted to be free from defects in material and manufacture for a period of ninety (90) days after the date of purchase of the 3M Product or 180 hours of lamp usage, whichever occurs first. This warranty is for parts only and in the case of an approved warranty claim for a lamp; your exclusive remedy will be for a replacement product shipped to your location.

Optional product upgrades and/or accessories that are not sold as part of any modular configuration are subject to individual warranties.

THE WARRANTIES STATED ABOVE ARE EXCLUSIVE AND ARE MADE IN PLACE OF ANY AND ALL WARRANTIES, EXPRESS OR IMPLIED WARRANTIES OR CONDITIONS, INCLUDING ANY IMPLIED WARRANTY OF MERCHANTABILITY OR FITNESS FOR A PARTICULAR PURPOSE, OR ANY INDUSTRY PRACTICE OR CUSTOM OR TRADE USAGE.

In the event the 3M Product fails to conform to the above stated warranties within the applicable warranty period, your exclusive remedy shall be, at 3M's option, to replace or repair the 3M Product or to refund the purchase price of the 3M Product. All replaced parts or products become property of 3M. If the product is repaired, 3M will repair the defective part(s) with a new or used part(s). If the 3M Product is replaced, 3M will replace the 3M Product with the same or equivalent model and with a new or refurbished 3M Product. In the case of an approved warranty claim, the replacement 3M Product will carry only the remaining term of the

ENGLISH

original 3M Product's warranty period as stated above. **For warranty service, you must provide proof of the date of the original purchase else the manufacturing code date will be used to establish the start date of the warranty.** The following are exclusions to the above listed warranty:

- a. This warranty does not cover 3M Product that is modified or damaged through improper storage, misuse, abuse, accident, vandalism, improper installation, neglect, improper shipping, damage caused by acts of war, disasters such as fire, flood, and lightning, improper electrical current, software problems, interaction with non-3M products, or service other than by a 3M Authorized Service Provider, neglect or mishandling by any person. Normal wear and tear is not covered under warranty.
- b. 3M Product is designed to operate in the typical indoor environment. This warranty does not cover 3M Product used outside of the following circumstances:
 - 100V-240V AC, 50/60 Hz
 - Office (or similar) Environments with low levels of smoke or air born particulates.

Altitude	Temperature	Humidity
0-4000 ft (normal fan speed)	5°C - 35°C (41°F - 95°F)	25% to 80% (non-condensing)
4000-6000 ft (high fan speed)	5°C - 35°C (41°F - 95°F)	

- Storage conditions: -20°C to 60°C, maximum 40,000 ft.
- c. The Air Intake and Exhaust Vent must be clear of obstructions, including any potential blockage or obstructions caused from a ceiling or other mount. Inadequate air ventilation will cause the 3M Product to malfunction or will cause damage to the 3M Product which will void the warranty.
- d. This warranty does not cover any additional costs including, but not limited to, those associated with removal, cleaning or installation of the 3M Product, adjustments, (mechanical or electronic) made to the 3M Product or replacing customer replaceable parts like lamps and air filters.
- e. This warranty covers only normal use of the product. 24-hour-per-day or other excessive continual use causes strain and is not considered normal use.
- f. This warranty does not cover consumables (e.g., fuses), other than lamps and only as set forth below.
- g. This warranty is not transferable.
- h. 3M is not responsible for warranty service should the 3M label or logo or the rating label or serial number be removed unless otherwise stated in writing for the purpose of private labeling for partnership requirements.
- i. This warranty does not cover postage, insurance, or shipping costs incurred in presenting your 3M Product for warranty service. Said costs are the customer's responsibility. If a claimed defect cannot be identified or reproduced in service, the customer may be held responsible for cost incurred. Should your warranty upgrade include a "change out" service and the claimed defect cannot be identified or reproduced by the technician, the customer will be responsible for call out costs.

FAILURE TO FOLLOW THE INSTRUCTIONS CONTAINED IN THE APPROPRIATE 3M PRODUCT MANUAL OR FAILURE TO USE THE 3M PRODUCT IN ACCORDANCE WITH 3M'S INTENDED USE STATEMENT, WILL VOID ALL WARRANTIES AND LIMITED REMEDIES.

EXCEPT AS SPECIFICALLY STATED IN THE APPLICABLE 3M PRODUCT MANUAL, 3M SHALL NOT BE LIABLE FOR ANY INDIRECT, INCIDENTAL, SPECIAL OR CONSEQUENTIAL DAMAGES (INCLUDING, BUT NOT LIMITED TO, LOSS OF PROFITS, REVENUE OR BUSINESS) RESULTING FROM, OR IN ANY WAY RELATED TO PERFORMANCE, USE OR INABILITY TO USE ANY OF THE 3M PRODUCT. This limitation applies regardless of the legal theory upon which damages are sought.

For warranty support, please call or write your local 3M office or a 3M Authorized Service Provider to obtain RMA # (Return Material Authorization Number) before returning the product. If you are inside the Continental United States of America, please contact 3M Customer Service at 800-328-1371 or email meetings@mmm.com.

What 3M Will Do To Correct Problems:

- If your 3M Product requires service, 3M will ask you to bring or send the 3M Product, securely packaged in its original container or equivalent, along with proof of the date of original purchase, to your 3M Service Dealer or 3M Service Center.
- 3M will, at its option, repair or replace the defective unit without charge for parts or labor. Return of the 3M Product will be at 3M's expense.
- When warranty service involves the exchange of the 3M Product or of a part, the item replaced becomes 3M property.
- The exchanged 3M Product or part may be new or previously refurbished to the 3M standard of quality, and at 3M's option, the replacement may be another model of like kind and quality.
- 3M's liability for replacement of the warranted 3M Product or part will not exceed the original retail selling price of the 3M Product. Exchange or replacement products or parts assume the remaining warranty period of the product covered by this limited warranty. However, each replacement lamp carries the limited 90-day warranty stated above.

Product Patents

This product is covered by one or more of the following patents:

U.S. Patent Number D555,184

U.S. Patent Number 7,123,426

U.S. Patent Number 7,126,767

U.S. Patent Number 7,271,964

Regulatory Notices

Video signal cables: Only use cables delivered by the manufacturer.

FCC STATEMENT - CLASS A: This device complies with Part 15 of the FCC Rules. Operation is subject to the following two conditions:

- (1) this device may not cause harmful interference, and
- (2) this device must accept any interference received, including interference that may cause undesired operation.

Instructions to Users: This equipment has been tested and found to comply with the limits for a Class A digital device, pursuant to Part 15 of the FCC Rules. These limits are designed to provide a reasonable protection against harmful interference when the equipment is operated in a commercial environment. This equipment generates, uses, and can radiate radio frequency energy and, if not installed and used in accordance with the instruction manual, may cause harmful interference to radio communications.

Operation of this equipment in a residential area is likely to cause harmful interference in which case the user will be required to correct the interference at his own expense.

Notice: This Class A digital apparatus meets all requirements of the Canadian Interference-Causing Equipment Regulations.

Cet appareil numérique de la classe A respecte toutes les exigences du Règlement sur le matériel brouilleur du Canada.

Instructions to Users: This equipment complies with the requirements of FCC equipment provided that the following conditions are met. The cables may have to be used with the core set to the projector side. Use the cables which are included with the projector or specified.

Note: Changes or modifications not expressly approved by the party responsible for compliance could void the user's authority to operate the equipment.

CE STATEMENT

Electromagnetic Compatibility Statement: Meets 2004/108/EC Directive

Low Voltage Directive: Meets 2006-95-EC Directive.

WEEE STATEMENT: The following information is only for EU-members States: The mark shown to the right is in compliance with Waste Electrical and Electronic Equipment Directive 2002/96/EC (WEEE). The mark indicates the requirement NOT to dispose the equipment as unsorted municipal waste, but use the return and collection systems according to local law.



RoHS STATEMENT: 3M Projection Systems can provide RoHS certification for products meeting the RoHS directive.¹

European (EU) Restriction of Hazardous Substances (RoHS) Directive, 2002/95/EC.

¹ RoHS compliant means that the product or part does not contain any of the substances in excess of the following maximum concentration values in any homogeneous material, unless the substance is in an application that is exempt under RoHS, as amended: (a) 0.1% (by weight) for lead, mercury, hexavalent chromium, polybrominated biphenyls or polybrominated diphenyl ethers; or (b) 0.01% (by weight) for cadmium. This information represents 3M's knowledge and belief, which may be based on information provided by third party suppliers to 3M.

Safety Information

Please read, understand, and follow all safety information contained in these instructions prior to the use of this projector. Retain these instructions for future reference.

Intended Use

Before operating the machine, please read the entire manual thoroughly. This product was designed, built and tested for use indoors, using 3M lamps and hardware. The use of other replacement lamps, outdoor operation or different voltages has not been tested and could damage the projector or peripheral equipment and/or create a potentially unsafe operating condition.

This projector is designed to operate in a normal office/classroom environment.

Altitude	Temperature	Humidity
0-4000 ft (normal fan speed)	5°C - 35°C (41°F - 95°F)	25% to 80% (non-condensing)
4000-6000 ft (high fan speed)	5°C - 35°C (41°F - 95°F)	

The ambient operating environment should be free of airborne smoke, grease, oil and other contaminants that can affect the operation or performance of the projector.

Use of this product in adverse conditions will void the product warranty.

Explanation of Signal Words and Symbols in Safety Labels and Instructions

WARNING: Indicates a potentially hazardous situation, which if not avoided, could result in death or serious injury and/or property damage.

CAUTION: Indicates a potentially hazardous situation, which if not avoided, may result in minor or moderate injury and/or property damage.



Warning: Hazardous Voltage



Warning: Hot Surface – High Temperature Lamp



Warning: High Pressure



Attention: Read Accompanying Documentation

⚠ WARNING**To reduce the risk associated with hazardous voltage:**

- Do not operate this projector in wet environments or outdoors.
- Do not modify this projector or power cord.
- Do not remove any screws other than those specified in the lamp replacement instructions.
- Do not attempt to service the projector other than the lamp cartridge. There are no user serviceable parts inside the projector.
- Contact a 3M authorized service provider for service.
- Disconnect power cord when the projector is not in use for extended periods of time, during lamp replacement, and while cleaning.
- Do not allow water or other liquids to enter the projector.

To reduce the risk associated with hazardous voltage and/or fire:

- Replace power cord if damaged.
- Contact a 3M authorized service provider if the projector becomes damaged.
- Use a grounded extension cord with a rating at least equal to that of the projector.
- Connect this projector to a grounded outlet.

To reduce the risk associated with choking:

- Keep the battery and battery cover away from children and pets.

To reduce the risk associated with hazardous voltage, impact, tripping, or intense visible light:

- Do not use this projector around unsupervised children.

To reduce the risk associated with sharp objects, premature lamp failure, exposure to mercury:

- Always handle the fragile lamp module with care.
- Replace the lamp module when the lamp replacement message appears.
- Never replace the lamp module with a previously used lamp module.
- Remove the projector from the ceiling or wall mount before replacing the lamp.

To reduce the risk associated with permanent vision impairment:

- Do not allow a child under the age of 8 years to view 3D images.

⚠ CAUTION**To reduce the risk associated with eye strain, nausea, dizziness, headache:**

- Take a break every hour for 15 minutes.
- Do not view 3D images or 3D full motion videos while standing or walking.
- Only use 3D Active Glasses for viewing field sequential 3D projected images.
- View 3D image from at least 2 m (7 feet) or greater distance.
- Make sure the right-eye and left-eye images are properly synchronized using the 3D menu of the projector.

To reduce the risk associated with falling:

- Do not view 3D images or 3D full motion videos while standing or walking.
- Do not allow anyone with a history of photosensitive diseases like epilepsy to wear 3D glasses or view field-sequential 3D projected images.
- Do not wear 3D Active Glasses while walking or standing.

To reduce the risk associated with intense visible light:

- Avoid looking directly into the projector lens while the lamp is on.

To reduce the risk associated with impact of a falling projector:

- Use only the 3M brand wall/ceiling mounting hardware kit if wall or ceiling mounting is desired.
- Installation of the 3M brand wall/ceiling kit must only be performed by qualified personnel.
- Adhere strictly to the proper installation procedure as outlined in the installation instructions when installing the 3M wall/ceiling kit.
- When not mounted, always operate the unit on a flat and sturdy surface.

To reduce the risk associated with explosion, and/or chemicals from leaking battery:

- Use only with battery type AAA.
- Orient the battery's plus (+) and minus (-) terminals according to the markings found on the remote control.
- Do not leave the battery in the remote for an extended period of time.
- Do not heat, disassemble, short, recharge, or expose the batteries to fire or high temperature.
- Do not carry batteries loose in your pocket or purse.
- Avoid eye and skin contact in the event that battery would leak.
- Do not mix used and new batteries.

To reduce the risk associated with tripping, and/or impact:

- Position the power cord and cables so that they can not be tripped over.

To reduce the risk associated with environmental contamination:

- Dispose of mercury lamp, exhausted batteries, and other electronic components in accordance with applicable federal, state and local regulations.

To reduce the risk associated with lamp rupture related hazards:

- In event of lamp rupture, call 3M authorized service provider for repair. Ruptured lamp repair is not user serviceable.
- Wash your hands thoroughly if contact with ruptured lamp debris has taken place.
- Ventilate the area where the lamp rupture occurs. The lamp operates at high temperature.

To reduce the risk associated with hot surface of lamp cartridge:

- Before replacing the lamp, allow the lamp to cool for 60 minutes and then unplug the projector from the electrical outlet.

To reduce the risk associated with environmental contamination due to mercury:

- Hg: Lamp contains mercury. Don't throw in trash. Dispose according to local, state, or federal laws. See www.lamprecycle.org or call 1-800-328-1371.

SAVE THESE INSTRUCTIONS

Safety Labels

The following safety labels are used on this product.

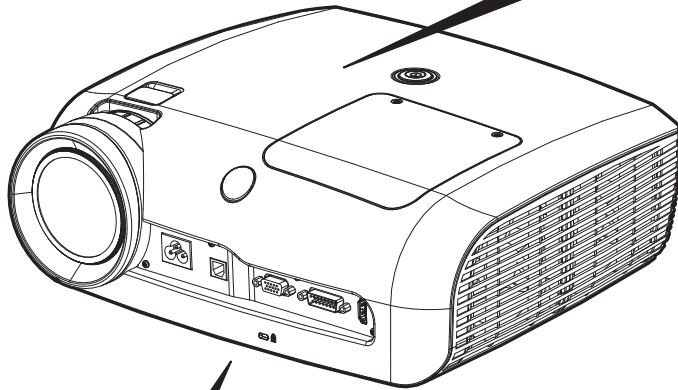

Warning: Read Manual Before replacing Lamp.

ADVERTENCIA: Lea el manual antes de cambiar la lámpara.

AVIS: Lire le manuel avant de remplacer la lampe.

WARNUNG: Lesen Sie im Handbuch nach, bevor Sie die Lampe ersetzen.

AVVERTENZA: Leggere il manuale prima di sostituire la lampada.

警告：ランプを交換する前に説明書を読んでください。

警告：在更換投影燈之前，請閱讀產品手冊。

警告：更換投影燈之前，請閱讀產品手冊。

경고：램프를 교체하기 전에 매뉴얼을 읽으십시오。



WARNING :

- BEFORE OPERATING, PLEASE READ OWNER'S MANUAL.
- DO NOT REMOVE SCREWS EXCEPT LAMP COVER SCREWS.
- DO NOT BLOCK VENTING OPENINGS.

AVIS :

- VEUILLEZ LIRE LE MODE D'EMPLOI AVANT L'USAGE.
- NE PAS RETIRER LES VIS A L'EXCEPTION DES VIS DU COUVERCLE DE LAMPE.
- NE BOUCHEZ PAS LES ORIFICES DE VENTILATION.

WARNUNG :

- VOR DEM EINSATZ DIE BETRIEBUNGSANLEITUNG LESEN.
- KEINE SCHRAUBEN AUSSER DEN LAMPENDECKELSCHRAUBEN ENTFERNEN.
- LUFTÜNGSÖFFNUNGEN NICHT BLOCKIEREN.

警告 :

- ご使用になる前に、取扱説明書をお読みください。
- ランプカバー以外のネジを取り外さないでください。
- 通気孔をふさがらないでください。

LAMP REPLACEMENT CAUTION

BEFORE REMOVING THE SCREWS, DISCONNECT POWER CABLE. HOT SURFACE INSIDE ALLOW 1 HOUR TO COOL BEFORE REPLACING THE LAMP. HANDLE WITH CARE, RISK OF EXPLOSION. SEE OWNER'S MANUAL.

PRECAUTIONS LORS DU REMPLACEMENT DE LA LAMPE

DEBRANCHER LE CABLE D'ALIMENTATION AVANT DE RETIRER LES VIS. L'INTERIEUR DU BOITIER ETANT EXTREMEMENT CHAUD, ATTENDRE 1 HEURE AVANT DE PROCEDER AU REMPLACEMENT DE LA LAMPE. A MANIPULER AVEC PRECAUTION. RISQUE D'EXPLOSION. SE REPORTER AU MODE D'EMPLOI.

ACHTUNG BEIM LAMPENAUSTAUSCH

VOR DEM ENTFERNEN DER SCHRAUBEN DAS NETZKABEL ABTRENNEN. HEISSE OBERFLÄCHEN IM INNEREN BENÖTIGEN 1 STUNDE ZUM ABKÜHLEN, BEVOR DIE LAMPE ERSETZT WERDEN KANN. VORSICHT BEIM UMGANG. EXPLOSIONSGEFAHR. SIEHE BETRIEBUNGSANLEITUNG.

ランプ交換の注意

ランプ交換をおこなう前に、必ず電源プラグをコンセントから抜いてください。内部は高温ですので、1時間以上放置してください。ランプは使用中に、まれに割れる場合があります。ランプ交換の際、ガラスの破片だけがをしないよう注意してください。詳しくは取扱説明書をご覧ください。

Hg: LAMP CONTAINS MERCURY. Don't throw in trash.
 Dispose according to local, state, or federal laws. See www.lamprecycle.org or call 1-800-328-1371.

Contents of Shipping Box

This projector is shipped with the necessary cables required for standard DVD player, PC or laptop computer connections. Carefully unpack and verify that you have all of the items shown below. If any of these items are missing, please contact your place of purchase.

The shipping carton contains the following items illustrated below. If any of these items are missing, please contact your place of purchase.

1. Projector
2. Remote Control Transmitter (AAA batteries included)
3. VGA to VGA cable, 1.8m (15-pin Male)
4. Power cord
5. Operator's Guide CD
6. USB A-B cable, 1.8m (not shown)

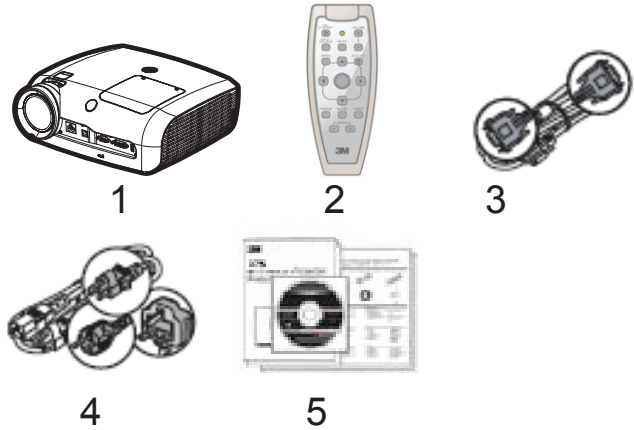

Keep Your Packing Materials

Save the shipping box and packing materials in the event this product should require shipping to a 3M Service Center for repair. Use packing material to protect projector.

What's Next?

Take a few minutes to review the machine characteristics before you setup and operate the projector. We hope you will enjoy using this high performance product in your classrooms, presentations and training sessions. This product has been produced in accordance with 3M's highest quality and safety standards to provide smooth and trouble-free use in the years to come.

Product Description

The 3M SCP725 integrates short-arc lamp and Digital Light Processing™ (DLP) technology. It accepts input from computer and/or video sources and projects a bright image through 3M™ Vikuiti™ Super Close Projection technology.

Machine Characteristics

The 3M SCP725 offers the following features:

- Native Resolution 1024x768 XGA
- On-screen menu with 9 languages (English, French, Deutsch, Spanish, Italian, Japanese, Chinese Traditional, Chinese Simplified, Korean)
- Lamp Life of 5000 hours (ECO mode)
- Lamp Life of 3000 hours (Bright mode)
- Image size: 30" to 150" diagonal
- Aspect Ratio: 4:3
- Digital keystone correction
- Vertical Lens Shift
- RS232 Control capable
- 3M Super Close Projection technology

Dimensions

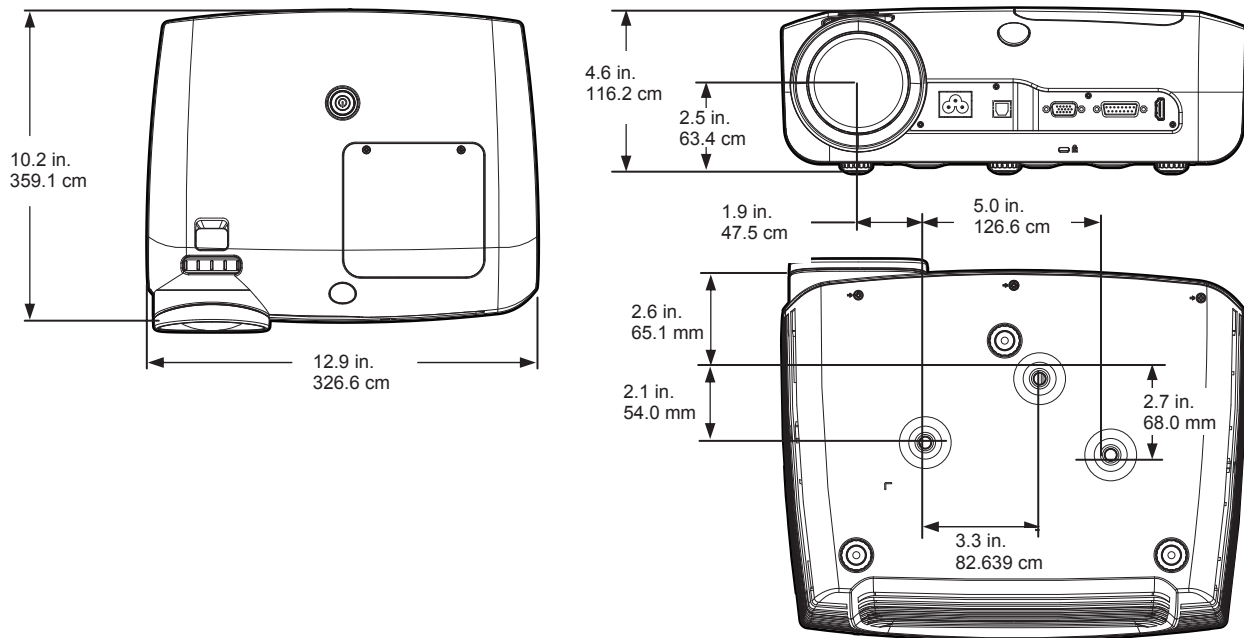

Projector Distance from Screen and Image Size

Refer to the chart below for the projector-to-screen distance and corresponding projected image size values.

Image Size			Distance (D)		Offset Min (S)		Offset Max (S)	
Diagonal	Width	Height (H)	in	mm	in	mm	in	mm
50	40	30	24 3/4	629	2 3/8	61	5 1/2	137
60	48	36	29 3/4	755	3	73	6 1/2	165
70	56	42	34 5/8	880	3 1/4	85	7 1/2	192
75	60	45	37 1/8	943	3 1/2	91	8	206
80	64	48	39 5/8	1006	3 3/4	98	8 3/4	219
90	72	54	44 1/2	1132	4 1/4	110	9 3/4	247
100	80	60	49 1/2	1258	4 3/4	122	10 3/4	274
150	120	90	74 1/4	1886	7 1/4	183	16 1/4	411

Vertical Lens Shift

The lens-shift feature will vertically offset the picture from 1 1/4 in. (30 mm) up to 4 1/2 in. (117 mm) depending on the projector-to-screen distance and size of the projected image. This adjustment is typically used with wall mount applications as a fine-adjustment to the vertical position of the projected image. Turn the adjustment screw to vertically raise or lower the physical position of the lens. Refer to the chart above for the offset values.

Note: The Lens-Shift adjustment screw does not adjust or change any keystone properties.

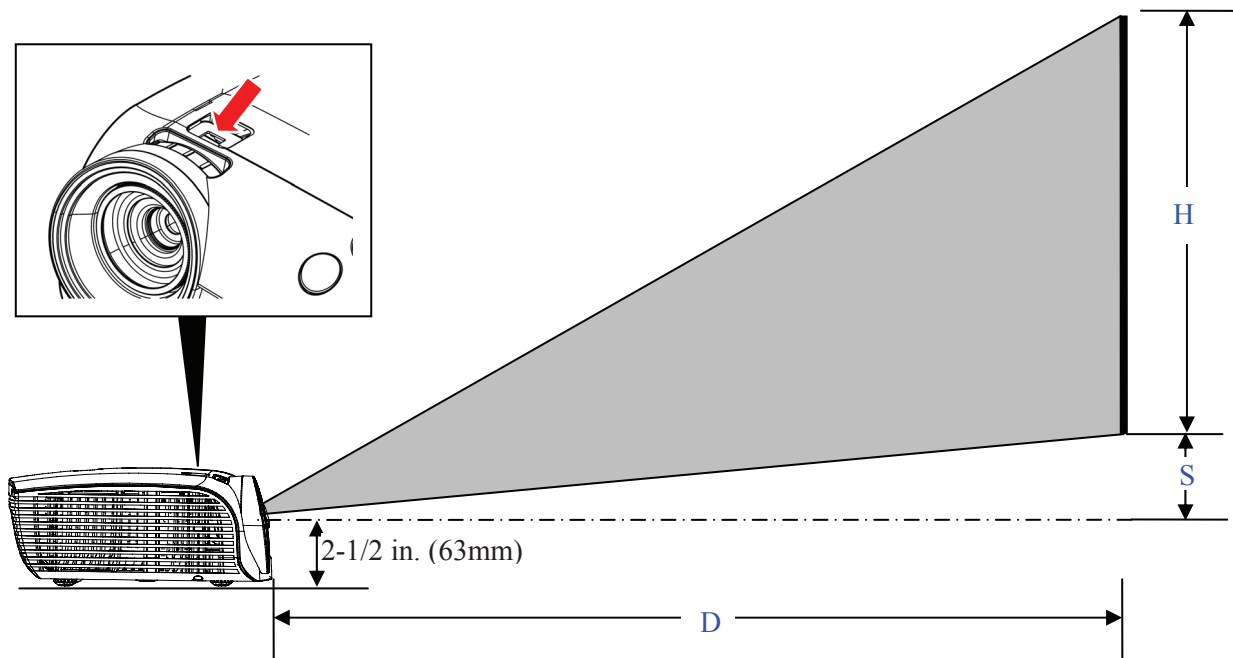

ENGLISH

Parts Identification

1. Super Close Projection Lens
2. Focus Adjustment
3. Lens-shift
4. Remote Control IR Sensor
5. Status Indicator Light
6. Standby/On Button
7. Lamp Cover
8. Ventilation Slots
9. HDMI Port
10. Control Input
11. Computer/Component Input
12. Slot for Kensington™ Lock
13. USB Port (For remote mouse functionality)
14. AC Power Cord Connection
15. Height Adjustment Foot

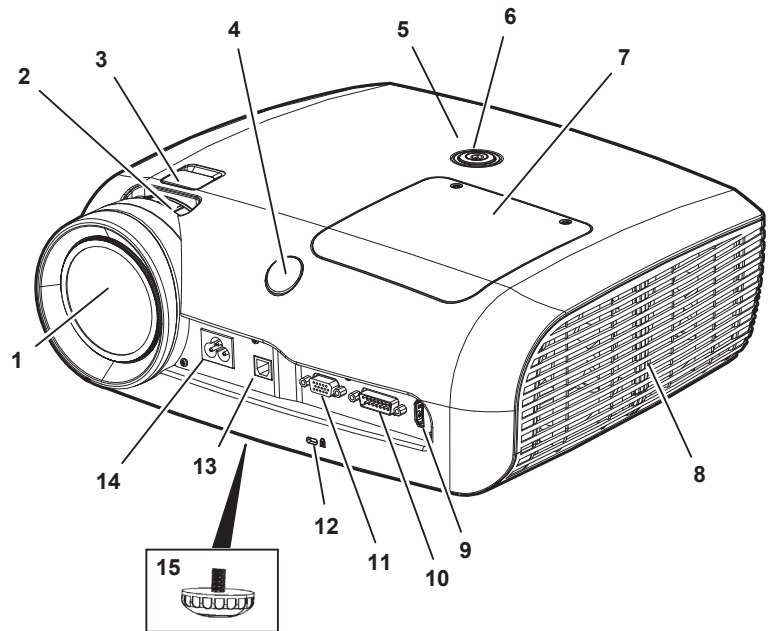

Projector Terminal Connections

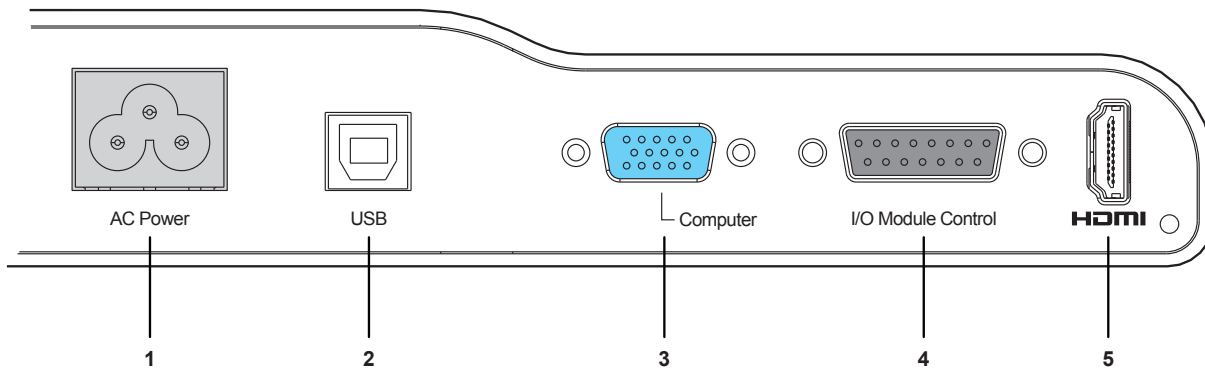

#	Projector Panel	Function
1	A/C Power	Connect AC power cord to projector.
2	USB	Connect projector USB (B-type) to computer USB port to control computer pointer with remote control.
3	COMPUTER	Input VIDEO signal from a computer source.
4	I/O Module Control	Connect projector control port to computer serial port with RS232 adapter or the 3M I/O Module and control the projector.
5	HDMI	Connect the projector a HDMI video source or DVI-D video source. The SCP725 does not connect audio through the HDMI port.

I/O Module Control Panel (optional accessory)

If your projector has the optional I/O Module installed, the projector functions can be operated from the I/O Module Control Panel.

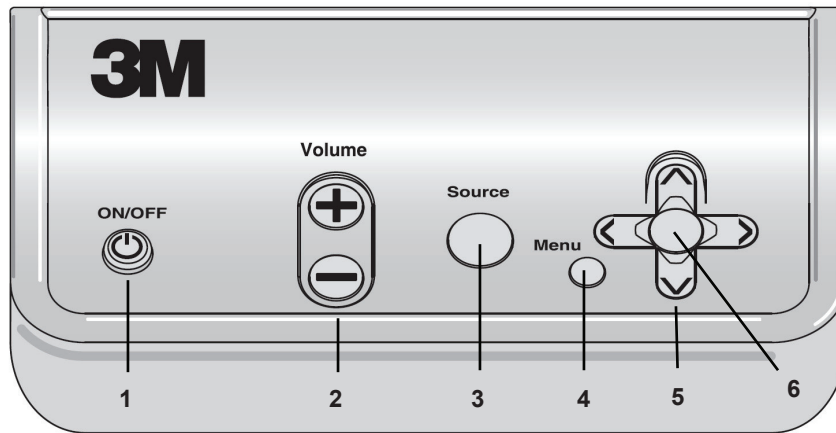

#	I/O Module Control Panel	Function
1	ON/OFF	Turns the projector on and off
2	Volume +/-	Increases (+) or decreases (-) audio level
3	Source	Switches the displayed input source. Switching order: Computer 1 => Computer 2 => S-Video => Video
4	Menu	Displays the projector's menu system.
5	Arrow Buttons	Navigate up/down or left/right through projector's Menu system.
6	ENTER (Center of Arrow buttons)	Select menu item and confirm menu selections

Top Terminal Panel on I/O Module

Use the Top Terminal Panel to connect the projector to the I/O Module box.

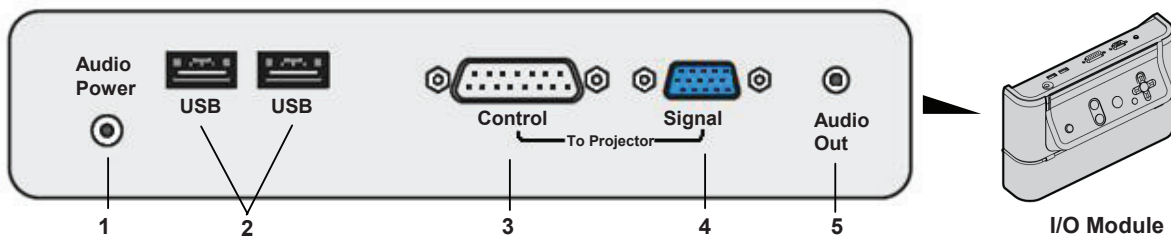

#	Top Terminal Panel	Function
1	Audio Power	Relay Audio power (from bottom terminal) through to speaker amplifier.
2	USB (Hub)	Connect two USB devices (like the projector's remote mouse) to a single USB port on computer connected to the I/O Module's bottom terminal panel.
3	CONTROL	Connect IO/Module to projector I/O Module CONTROL terminal.
4	Signal	Connect I/O Module to projector COMPUTER port.
5	Audio Out	Connect IO/Module to external speakers or speakers in 3M Folding Wall Mount FWMSV2.

ENGLISH

Bottom Terminal Panel on I/O Module

Use the Bottom Terminal Panel to connect the I/O Module box to the Computer/Video source.

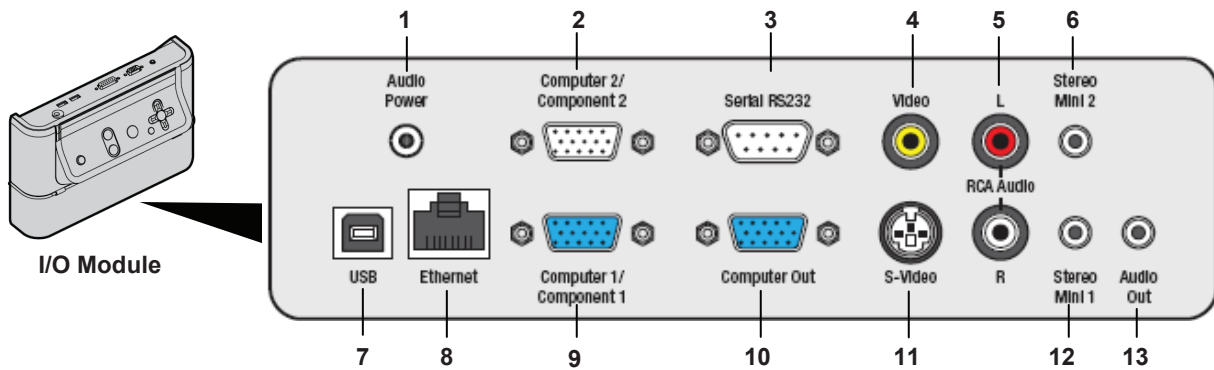

#	Bottom Terminal Panel	Function
1	Audio Power	Supplies power to 3M Folding Wall Mount speakers from the power supply included with the 3M Folding Wall Mount.
2	Computer2/Component2	Input for computer or component video device.
3	Serial RS-232	Passes control commands from a computer or control system to the projector.
4	Video	Input for composite video devices.
5	RCA Input R/L	Right and Left Channel Audio Input.
6	Stereo Mini 2	Stereo Audio input for Computer2.
7	USB	Connects the two devices connected to the top terminal panel USB ports to a computer.
8	Ethernet	Allow access to the projector control webpage and control command over a network remote monitoring & control.
9	Computer1/ Component1	Input for computer or component video device.
10	Computer Out	Output the signal from the Computer 1 port.
11	S-Video	Video device input for S-video
12	Stereo Mini 1	Stereo Audio input
13	Audio Out	Connects selected audio input to active speakers or audio amplifier.

Remote Control Functions

Use a USB cable to connect from the PC to the SCP725 or SCP I/O Module (*if equipped*) and aim the remote control toward the projection screen or at the IR sensor on the projector. Press desired remote control button to send a signal to the projector.

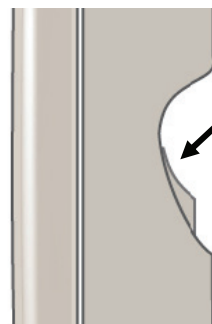
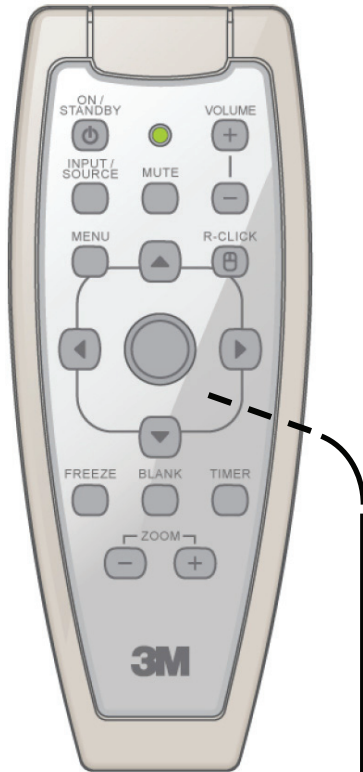

Trigger button is bottom of remote

ON/STANDBY	ON: Press to turn projector ON. OFF: Press to display confirmation message, press again to switch projector to Standby mode. Note: The confirmation message displays to ensure unit does not get turned off accidentally.
INPUT/ SOURCE	Press for current input source. Press again to select different computer/video input. Computer 1/Component 1 → Computer 2/Component 2 → RCA Composite Video → S-Video → HDMI]
Volume +:	Press to increase speaker volume.
Volume -:	Press to decrease speaker volume.
Mute:	Press to switch the audio sound ON or OFF.
Menu:	Press to display the Main Menu. When a menu is open, press to exit menu.
R-Click	Performs remote Right Mouse click function (when USB is connected to projector USB).
Up Arrow	Moves cursor upward through menu items.
Down Arrow	Moves cursor downward through menu items.
Left Arrow	Moves cursor left through menu items. Moves .ppt slides backwards.
Right Arrow	Moves cursor to right through menu items. Moves .ppt slides forward.
Mouse Pad (between arrows)	Allows remote mouse functions. Allows Pan function when in Zoom mode.
Blank:	Press to replace projected image with black image. Press again to return projection image.
Freeze:	Press to temporarily freeze movement on current image in motion. Press again to return to active image. <i>Note: This function is intended for a few minutes only.</i>
Timer:	Press to initiate a 10:00 minute digital timer. Press up/down arrows to change timer clock by 1 minute intervals up to 99:00.
Zoom +:	Press and hold to increase the size of the displayed image up to 200 percent.
Zoom -:	Press and hold to decrease size of the displayed image down to 100 percent
Bottom Trigger	Pull trigger for remote LEFT mouse button functions. In menu mode, use for remote Enter / Select functions.

ENGLISH

Installing Batteries in Remote Control

1. Push down on cover to unlatch it. Slide cover off.
2. Install new AAA batteries with the correct polarities.
3. Reinstall battery cover.

Note: Verify the battery cover is fully latched before using the remote control.

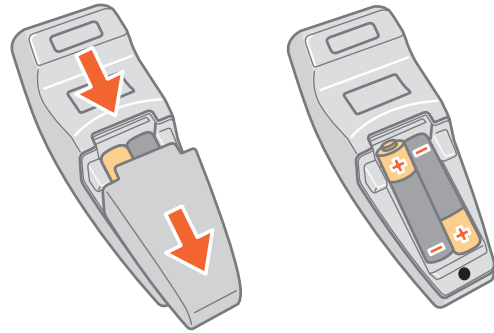

Setup and System Configuration

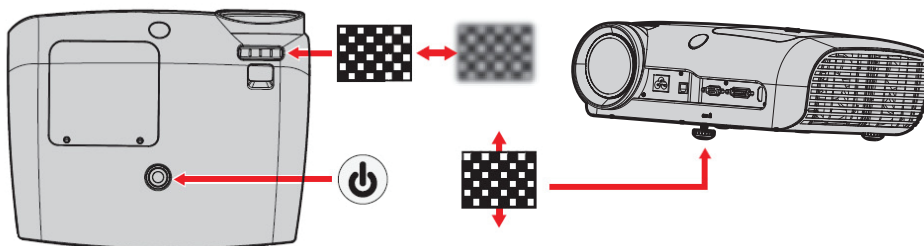
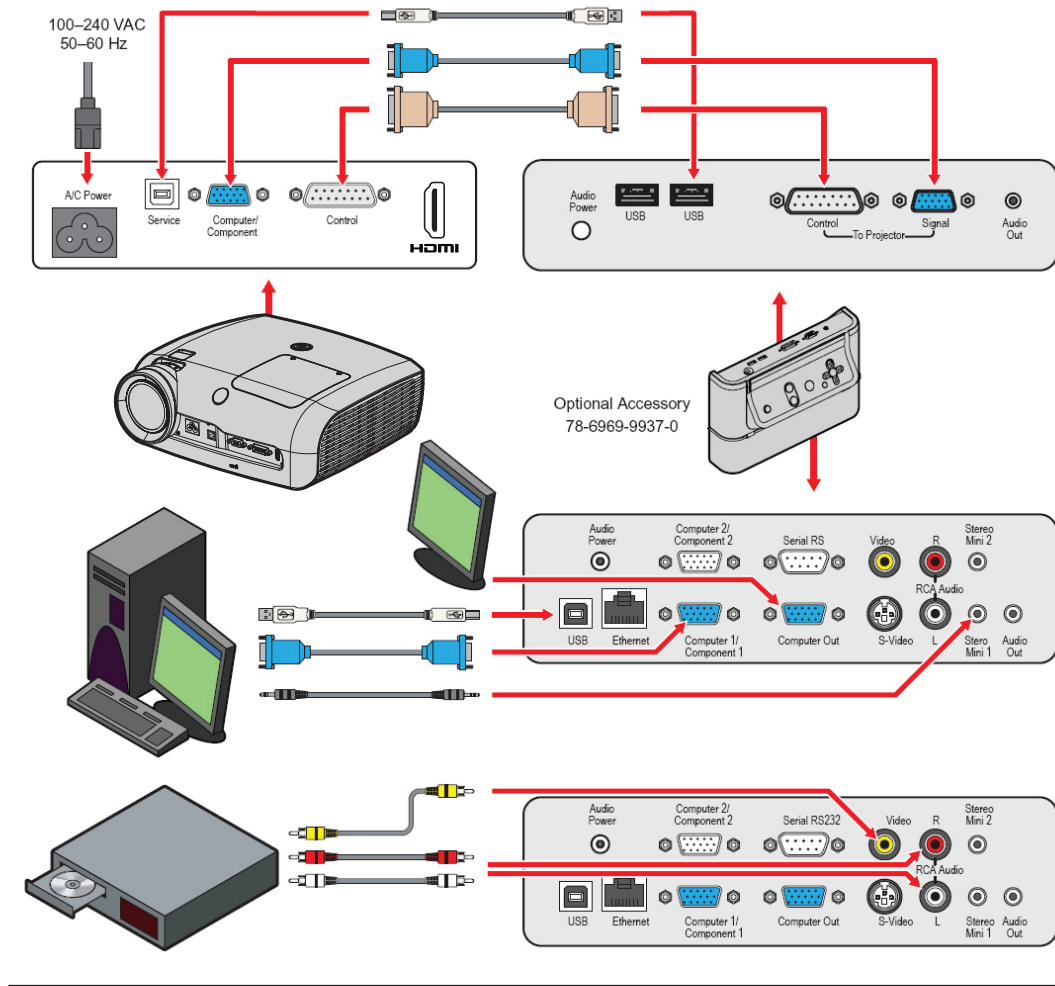

Operating Instructions

Projector Start Up

Read the Important Safeguards before operating the SCP725. After all cable connections have been completed, refer to Setup and Configuration, the projector can be powered up.

For best results, please observe the following start up sequence.

1. Power ON all of the connected equipment.
2. Plug the supplied power cord into the AC inlet of the projector.
3. Press the On/Standby button on the projector or remote control. The lamp will turn on and an image will appear and grow brighter on the screen.
4. If the security feature is activated, enter the 4-digit PIN code.
 - a. Press the left/right arrow to move the cursor through each PIN field.
 - b. Press the up/down arrows to change the value in each field.
 - c. Press the Trigger button on the remote to enter the PIN access code.
5. Check all ventilation slots and clear away any obstructions.
6. Extend or retract front adjustment foot to obtain best image height.



Note: Rotate foot for fine adjustment.

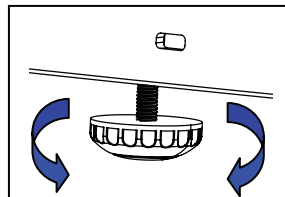

7. Turn the focus adjustment (top of projector) to obtain the best image sharpness.

Stand By Mode

When an image is not being projected, place the unit into standby mode.

1. Press the On/Standby button on the Remote Control or the On/Off button on the I/O Box. When the message "Press the power button to turn the unit off" displays, press the On/Standby button again.
2. The lamp will switch off and the power button will first turn red indicating the unit is in lockout and then after 90 seconds the button turns amber to indicate the unit is in standby mode.

Note: In standby mode, the cooling fans will continue to run for 5 minutes and then turn off.

Menu Navigation

To display the on screen menus, press the MENU button on the remote control or I/O Module. Use the remote control Up/Down ARROW buttons to select the desired menu (see table below), then pull the TRIGGER button (bottom of remote control) to display it.

Use the remote control ARROW buttons within a submenu to select the various options displayed on the screen, then pull the TRIGGER button to initiate that option or setting.

To exit an on-screen submenu, press the MENU button.

Main Menu

The main menu is the first system menu to display when the MENU button is pressed. Click on the menu icons to display the desired submenu.

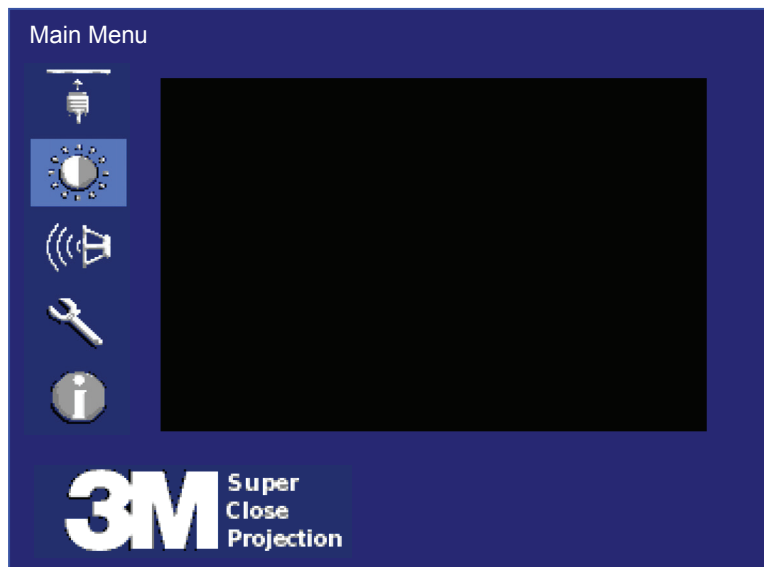

Menu Icon	Menu Description
	Input Menu – Select the desired computer or video input source.
	Picture Menu – Adjust the following picture features: mode, brightness, contrast, color intensity, tint, sharpness, video noise reduction, aspect ratio, and menu reset. Note: Displays only when input source is connected.
 Advanced	Advanced Picture Menu – Adjust the following settings for the detected signal source: over scan, brightness/color, horizontal position, vertical position, frequency, phase, & menu reset.
	Audio Menu – Adjust the following audio settings: volume, mute, audio input (stereo mini-1, stereo mini-2, RCA), menu reset.
	Setup Menu – Select or adjust the following settings: menu languages, auto shutoff timer, keystone, lamp hours, lamp mode, fan mode, projection mode, factory reset, PIN code and menu reset.
	Information Menu – Display the current system information: input resolution, H/V frequency, lamp hours, system hours, IP address/net mask/gateway for I/O module Ethernet interface, user revision.

Input Menu

The Input Menu, shown below, is used to select the desired computer or video input source to be displayed on the projector.

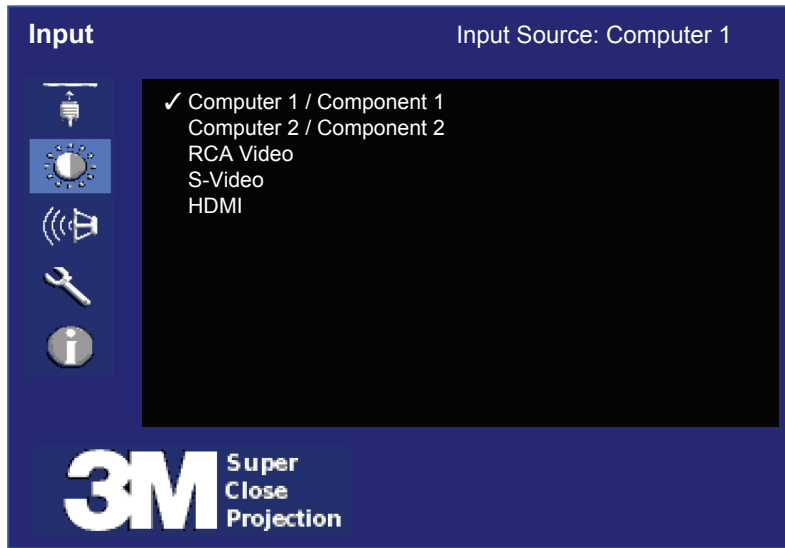

ENGLISH

Feature	Description
Main Input	Select the Input source to be displayed on the projector.
	1. Computer 1 / Component 2 [Computer 1 = default]
	2. Computer 2 / Component 2 [Displays only when I/O module is connected]
	3. RCA Video (Composite video)
	4. S-Video
	5. HDMI

Picture Menu

The Picture Menu, shown below, is used to adjust the picture settings to display the best possible image.

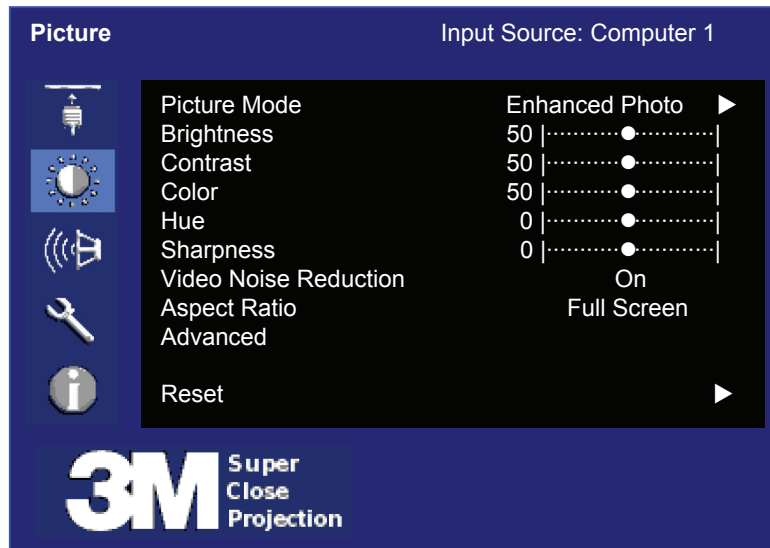

Feature	Description	Range	Default
Picture Mode	Select the best mode to optimize the projector image. 1. Max Brightness 2. Enhanced Photo 3. Enhanced 4. Photo	N/A	VGA-Max Brightness Video-Enhanced Photo
Brightness	Adjust brightness (low to high) of displayed image	0–100	50
Contrast	Adjust the contrast (dark to light) in the displayed image	0–100	50
Color * (see note)	Adjust the intensity of color in the displayed image	0–100	50
Hue * (see note)	Adjust the balance of red (-) to green (+) for video signals.	-15–+15	0
Sharpness	Adjust the displayed image to look sharper or softer	-15–+15	0
Video Noise Reduction	Turn noise reduction ON or OFF	N/A	Off
Aspect Ratio	Set aspect ratio to: [Full Screen or 16:9 or Native]	N/A	Full Screen
Advanced	Navigate to the Advanced picture setting menu. This option is for Computer/Component input and only displays when the I/O Module is connected.	N/A	N/A
Reset	Reset values in this menu only	N/A	N/A

* Note: Tint/Hue can only be adjusted for S-Video and RCA video input signals

Advanced Picture Menu

The Picture Menu with the Advanced option selected, shown below, is used to adjust the projected image for Computer and Component inputs only.

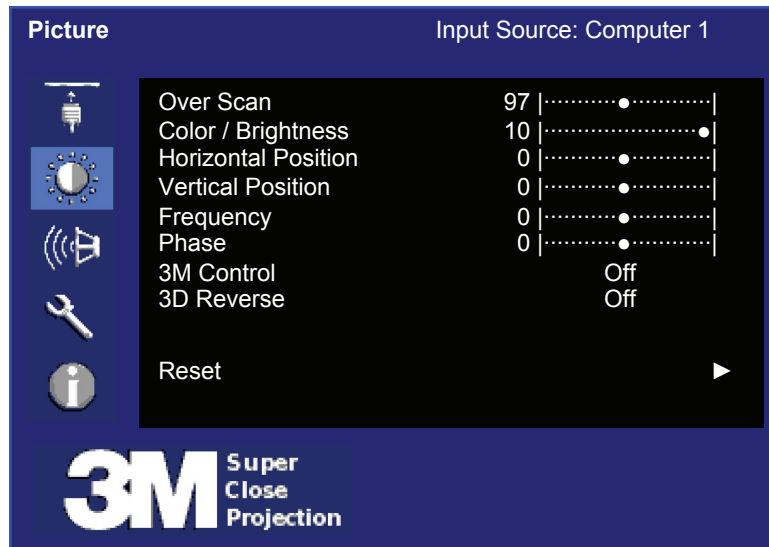

Feature	Description	Range	Default
Over Scan	Adjust cropping of image boundaries from 90th to 100th percentile (increments of 1 percent).	90–100	Video = 97 VGA = 100
Brightness / Color	Adjust the white peaking value of the DMD. (0 = lowest white peaking value, 10 = highest value)	0–10	Computer = 10 Video = 3
Horizontal Position	Adjust horizontal position of projected image. (Only for Computer 1 or Computer 2 input source)	N/A	0
Vertical Position	Adjust vertical position of projected image. (Only for Computer 1 or Computer 2 input source)	N/A	0
Frequency	Adjust the horizontal width of the projected image. (Only for Computer 1 or Computer 2 input source)	-50–+50	0
Phase	Adjust clock phase to reduce image distortion. (Only for Computer 1 or Computer 2 input source)	-15–+15	0
3D Control	Turns on or off TI 3D DLP-Link. On reverts to Off but Always On is not affected when the projector is removed from its power source.	On / Off / Always On	N/A
3D Reverse	Turn on 3D Reverse. 3D Reverse flips the order of the left and right image for the eyes in the event they are out of sync. The left and right image are out of sync when the images in the background appear closer than the image in the foreground. On reverts to Off but Always On is not affected when the projector is removed from its power source.	On / Off / Always On	N/A
Reset	Reset values in this menu only	N/A	N/A

Audio Menu

(Menu displays only if I/O Module is connected)

The Audio Menu, shown below, is used to adjust the audio settings and select the audio input source to play through the projector.

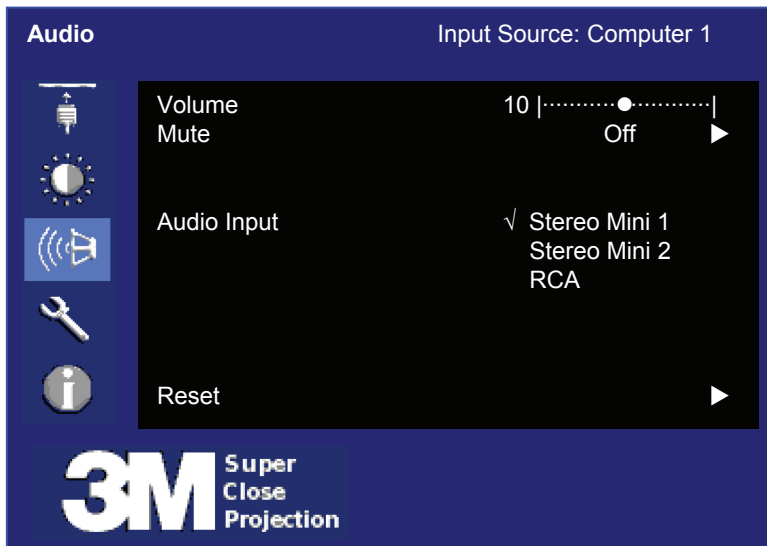

Feature	Description	Range	Default
Volume	Adjust volume level (0 = muted, 20 = full volume)	0–20	10
Mute	Turn mute mode ON and OFF	N/A	OFF
Audio Input	Select the audio input source to process. Stereo Mini 1 – VGA/Component Stereo Mini 2 – VGA2/Component RCA – S-Video/Component	N/A	PC
Reset	Reset values in this menu only	N/A	N/A

ENGLISH

Setup Menu

The Setup Menu, shown below, is used to configure the basic projector operating parameters.

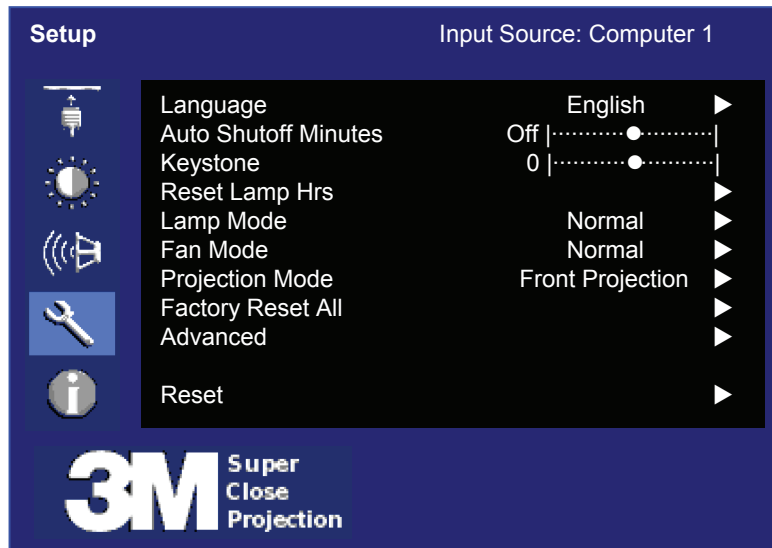

Feature	Description	Range	Default
Language	Select the language for menu displays [1-English, 2-French, 3-Spanish, 4-German, 5-Italian, 6-Japanese, 7-Chinese Traditional, 8-Chinese Simplified, 9-Korean]	N/A	English
Auto Shutoff Minutes	Set the number of idle minutes (no input source detected and no commands issued) before the projector will automatically shut off.	0–60	10
Keystone	Vertical keystone adjustment.	-40 – +40	0
Reset Lamp Hours	Reset lamp hour status indicator. <i>See Information Menu.</i>	N/A	N/A
Lamp Mode	Bright, Normal, ECO	N/A	Normal
Fan Mode	Normal, High	N/A	Normal
Projection Mode	1-Front Projection, 2-Rear Projection, 3-Front Ceiling, 4-Rear Ceiling	N/A	Front Projection
Factory Reset	Reset all menu items to FACTORY DEFAULT settings	N/A	N/A
Advanced	Select the Advanced Setup Menu.	N/A	N/A
Reset	Reset values in this menu only	N/A	N/A

Advanced Setup Menu

The Advanced Setup Menu, shown below, is used to initiate the PIN code feature (turn On/Off) and set the PIN code.

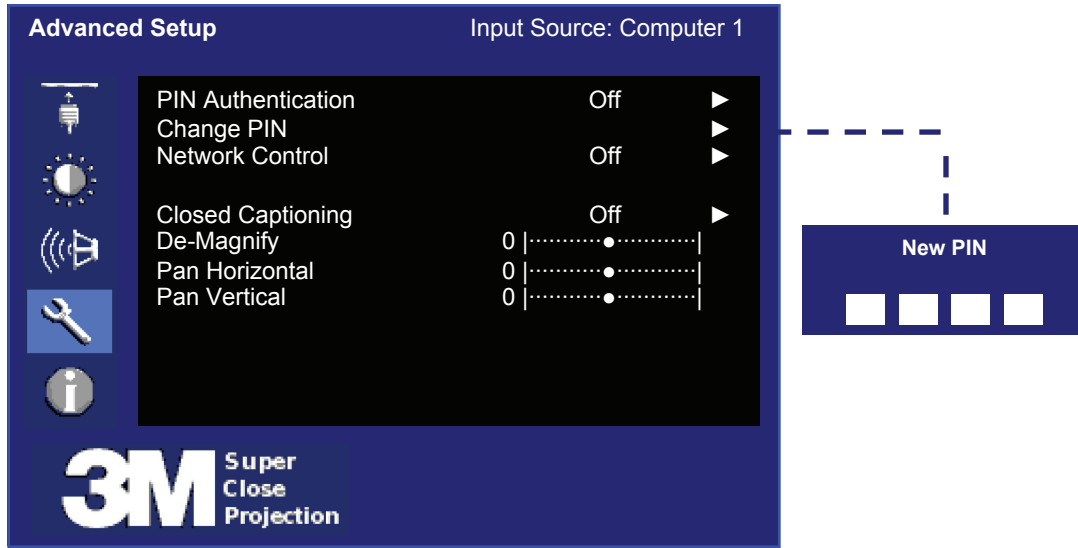

ENGLISH

Feature	Description	Range	Default
PIN Authentication	Turn the PIN code security feature On or Off.	N/A	Off
Set PIN code	Change the 4-digit PIN access code as desired. <i>Note: When PIN security is enabled, the PIN access code will automatically set to the default value 3349.</i>	0-9	3349
Network Control	Turns the network control function on and off. The network control feature allows a computer to open the control web page on I/O module and control the projector. To view the control web page, connect the I/O module into the local area network and type the I/O module's IP address into the address bar of a web browser. (The IP address can be found in the projector's information menu. See the next page.) The control web page will display. A RS-232 and network control guide is available at www.mmm.com/meetings in the Technical Documents section.	On/Off	On
Closed Captioning	Turns on Closed Captioning. CC1, CC2, CC3, and CC4 are the different Close Caption channels. CC1 is the primary channel for most content. The content on CC2, CC3, and CC4 may vary on video source.	Off / CC1 / CC2 / CC3 / CC4	Off
De-Magnify	Reduces the image size from 100% to 50% of the projected image size.	50 to 100	100
Pan Horizontal	Positions the image horizontally	-5 to +5	0
Pan Vertical	Positions the image vertically	-5 to +5	0
Reset	Reset setting to factory default.		

Information Menu

The Information Menu, shown below, is used to display current projector configuration settings.

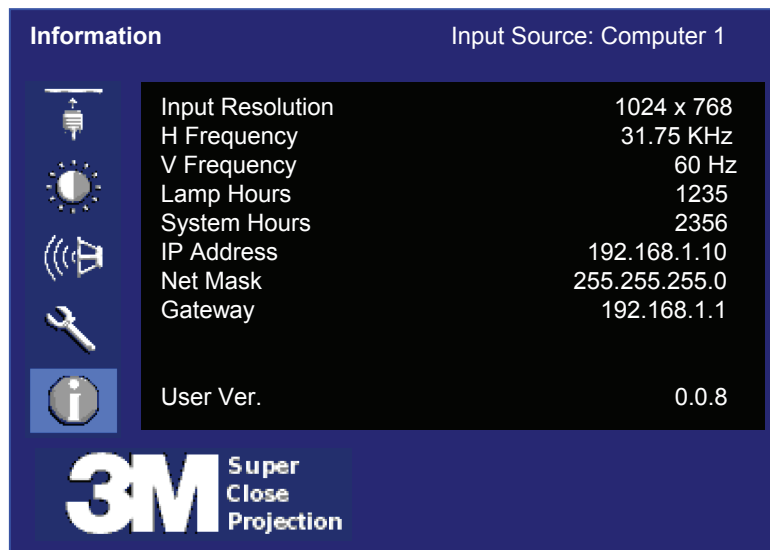

Feature	Description
Input Resolution	Displays the current input Resolution
H Frequency	Displays the current input H-Frequency
V Frequency	Displays the current input V-Frequency
Lamp Hours	Displays the current lamp operating hours for the installed lamp
System Hours	Displays the current total system time accumulated
IP Address * (see note)	Displays the current IP Address for the I/O module Ethernet interface
Net Mask * (see note)	Displays the current Net Mask for the I/O module Ethernet interface
Gateway * (see note)	Displays the current gateway for the I/O module Ethernet interface
User Revision	Displays the current User Version

*** Note:** This field displays only when the I/O Module is connected.

Machine Specifications

Item	Specification
Acoustic Noise Level	Bright Mode: Typical 34 dB(A) Normal Mode: Typical 32 dB(A) ECO Mode: Typical 28.5 dB(A)
Auto Detect & Install	Automatically recognizes the connection of I/O module Automatically saves user adjustments
Computer Compatibility	Horizontal Sync: 69 kHz Vertical Sync: 85 Hz
Conditions for usage environment	Rel Humidity: 10-80% Altitude: 0-2286m (0-6000ft) Temperature: /10-35C (50-95F)
Dimensions	328.94 x 264.0 x 116.43 mm (13.2 x 10.6 x 4.7 inches)
DMD Native Resolution	1024x768 (XGA)
Focus	Manual Adjustment
Input / Output Terminals	HDMI connector VGA (mini D-sub 15-pin) connector Control connector USB (A-B) AC power outlet
Input rating	100-240V AC, 50-60 Hz, 4.0A
Lamp Life	3000 hrs at 230W Bright mode 5000 hrs at 180W ECO mode
Languages	English, French, Spanish, Deutsch, Italian, Japanese, Chinese Traditional, Chinese Simplified, Korean
Lens	Focal Length = 8.9 mm
Power Consumption	300W normal operation, 5W standby mode
Video Compatibility	NTSC: M, N, 3.58Mz, 4.43 MHz PAL: B, D, G, H, I, M, N SECAM
Wall/Ceiling Mount capability	Three screw holes
Weight	4.5kg (10 lbs)

Note: Designs and specifications are subject to change without notice.

Maintenance

Lamp Replacement

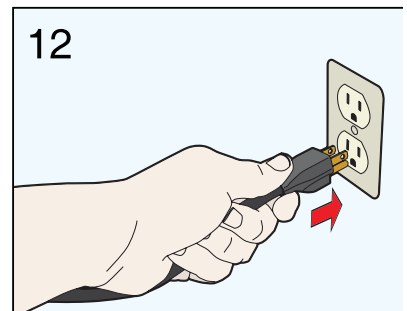
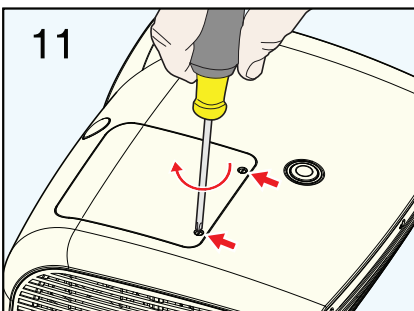
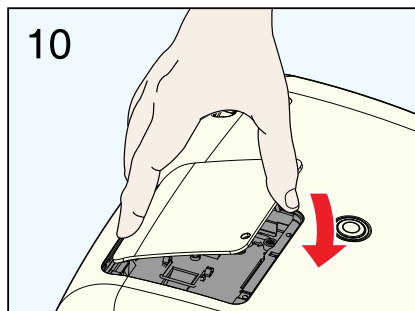
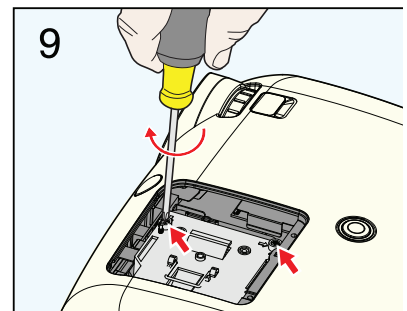
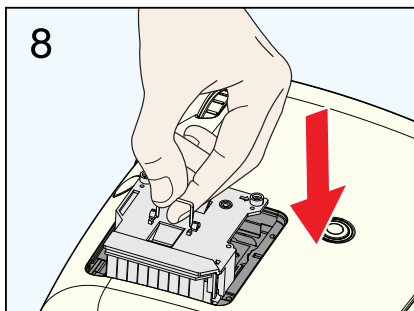
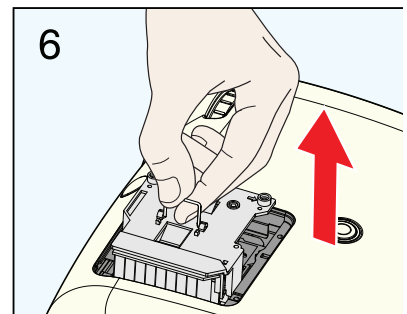
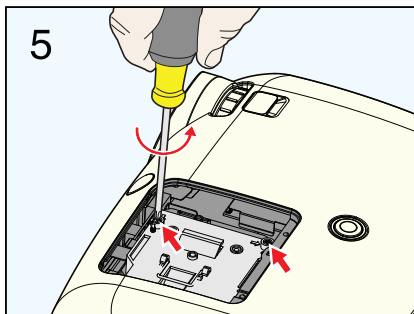
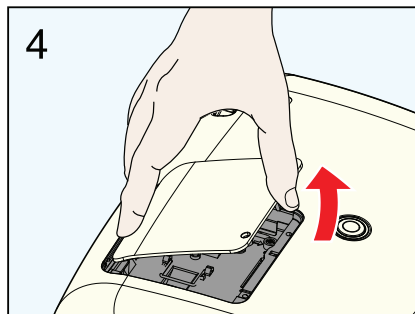
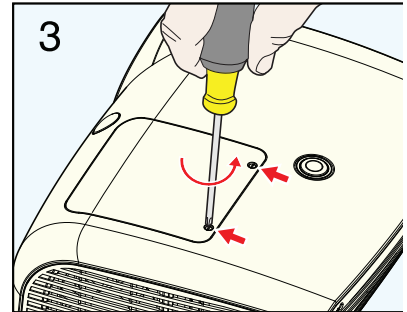
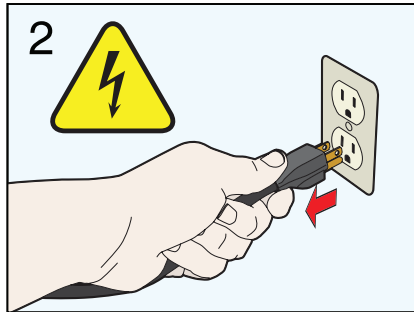
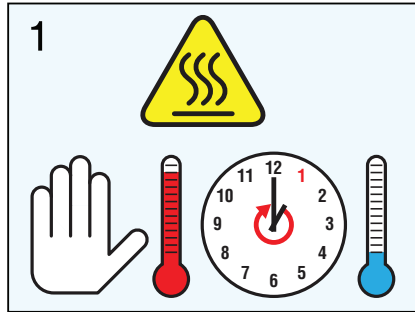

Note: Refer to the Setup Menu to reset the lamp hour timer after replacing the lamp.

ENGLISH

Cleaning the Air Vents

For best performance, 3M recommends that you periodically dust the projector and vacuum all air vents on the projector.

Follow the procedures below.

1. Return projector to standby mode. After the Standby button turns amber and the fan stops, unplug the power cord from the wall outlet.

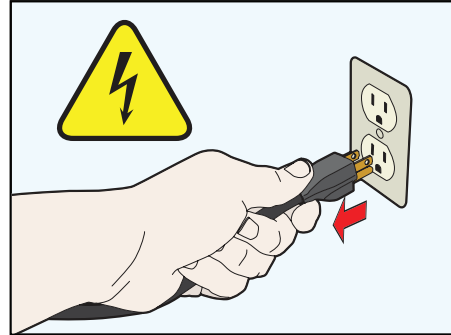

2. When dust or dirt appears on the projector's top surface or around the air vents, clean these areas before operating the projector.
 - a. Wipe the top surface with a clean/dry cloth or use a vacuum cleaner.
 - b. Vacuum the intake air vent while gently tapping on the vent slots to dislodge any dirt.
 - c. Vacuum the exhaust air vent while gently tapping on the vent slots to dislodge any dirt.

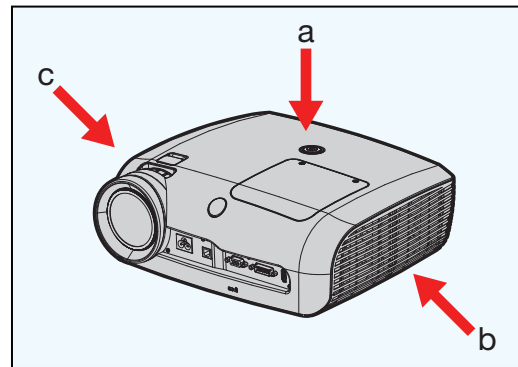

3. Plug in the power cord and press the standby button to power on projector. Test unit to verify it operates correctly.

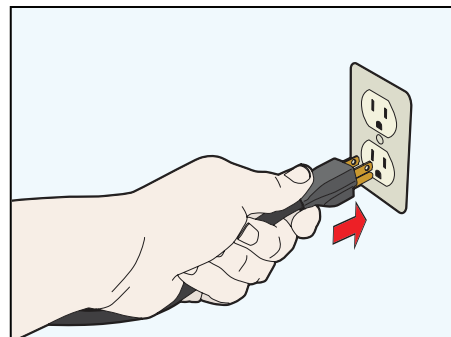

Cleaning the Lamp Module and Lamp Compartment

For best lamp performance, there must be adequate air flow through and around the lamp module. A build up of dust or dirt will reduce the air flow and shorten lamp life and lamp performance. 3M recommends at every lamp change or at least once a year that air vents, lamp module and lamp compartment be cleaned with a vacuum.

Follow the procedure below.

1. Unscrew lamp module retaining screws and carefully remove lamp module.

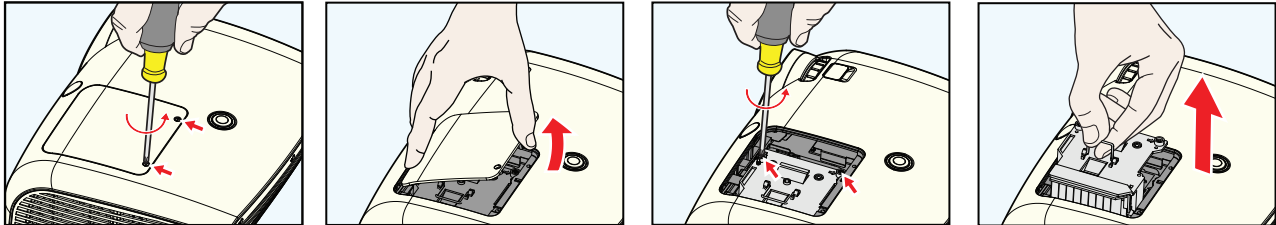

2. Vacuum the lamp cavity to remove all dislodged dust.

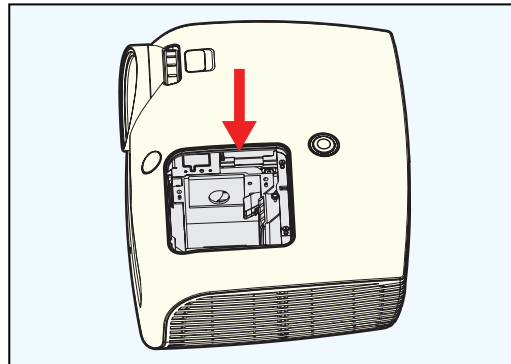

3. Vacuum the lamp inlet and exhaust vents to clear any dust or dirt build up.

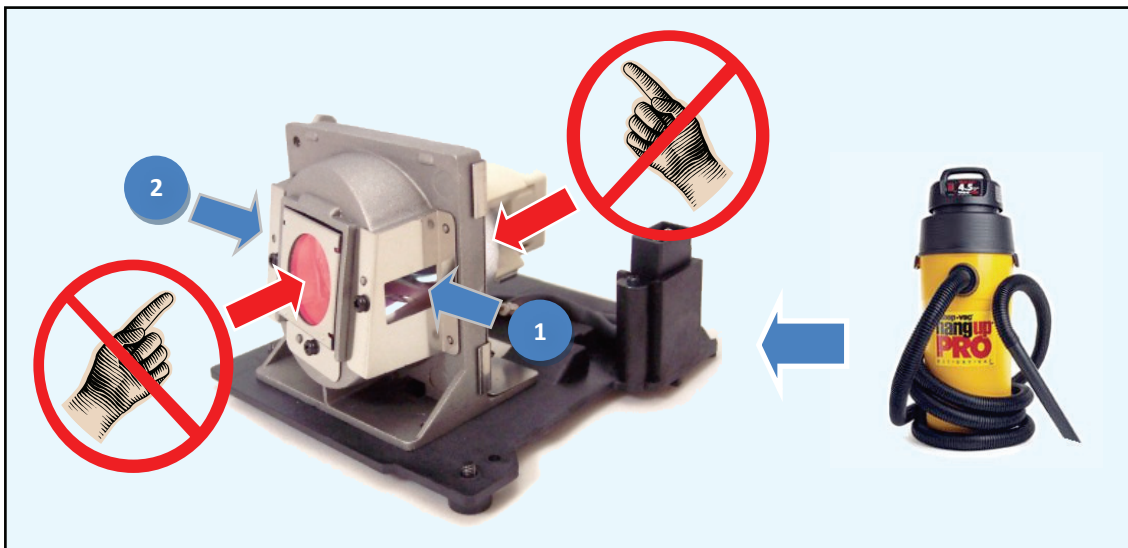

Important Note: Do not touch the glass reflector or the bulb. If oils from your skin transfer to the glass it will weaken the heat resistant properties of the reflector/bulb and significantly shorten the lamp's life.

4. Install the lamp taking care to seat it fully into the lamp socket connection and tighten the lamp retaining screws.

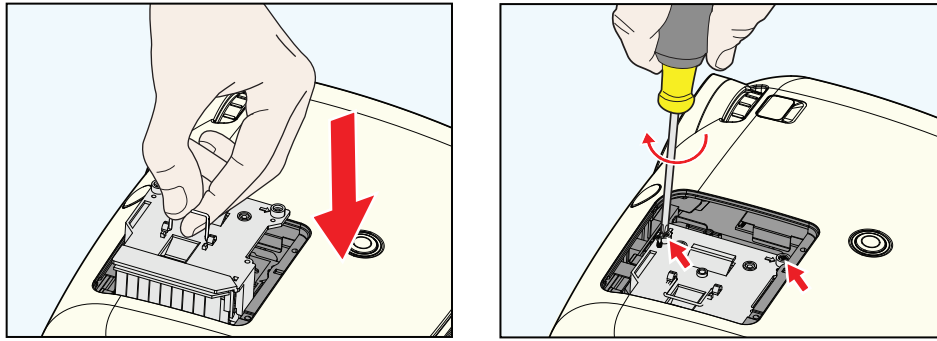

5. Replace the lamp door and secure it with the retaining screws.

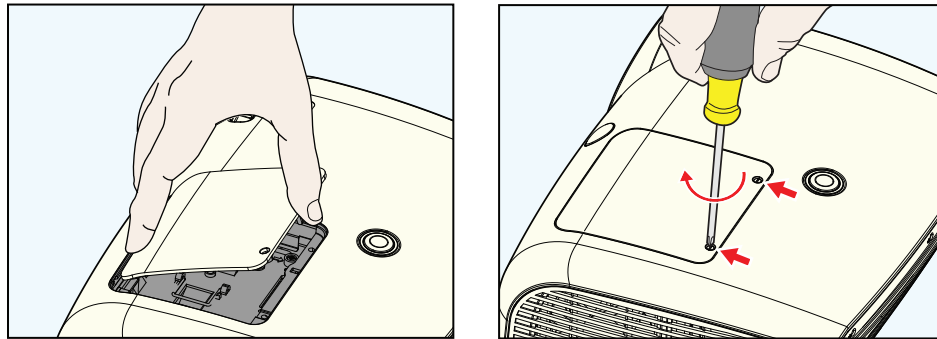

6. Verify the projector operates correctly. Plug in power cord and press the standby button to power on projector.
Note: If the lamp door is not installed correctly, the projector will not power on.

Troubleshooting

Identifying an Expired Lamp Module

Lamp Module Parts

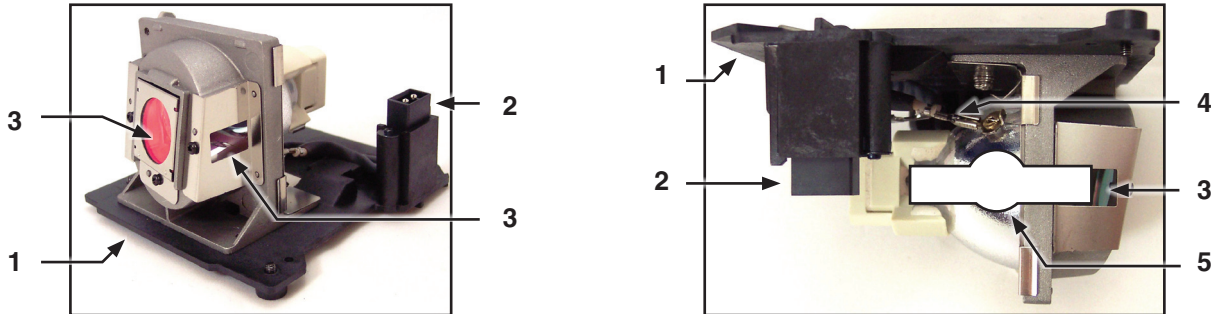

1. Top of Lamp Module
2. Lamp Connector
3. Air Vents
4. Lamp Wires
5. Bulb Envelope - This is the shape of the bulb inside the lamp module.

Visible Indications of an Expired Lamp

The following five visible indicators help you recognize an expired lamp.

1. Cloudy Bulb – A cloudy bulb may reduce the image brightness. The lamp will appear to have white or black deposits on the inside of the bulb. These deposits are a sign of normal wear and tear. Replace the lamp if the brightness is inadequate.
2. Disconnected or broken wires – If the lamp wires are broken, the lamp will not ignite. Replace the lamp if the lamp wires are broken
3. Deformed Bulb – A deformed bulb will reduce the image brightness. A bulb is deformed when the bulb envelope expands into an irregular, round shape. Replace the bulb if it becomes deformed.
4. Debris on Bulb End – If the lamp will not ignite, the bulb seal may have broken. When bulb seal is broken, debris from the bulb will form at the break. Most of the times, this is at the bulb tip.
5. Broken Bulb – The lamp will not ignite if it is broken. Sometimes you will hear an abnormal sound when you try to start the projector. Please refer to the Safety Instructions for more information about handling broken bulbs.

I/O Module Troubleshooting

Symptom	Possible Cause	Solution
The Standby button on the I/O module does not light while the projector is powered on.	The communication cable is not connected or is damaged.	Connect a communication cable (15 pin to 15 pin) from the projector to the I/O module.
	The projector does not have power.	See projector troubleshooting

Projector Troubleshooting

Symptom	Standby Button State	Possible Cause	Action
The projector will not turn on	Off	The power cord is not connected to projector and an electrical outlet.	Insert the power cord into electrical outlet.
		The lamp door is not installed, or is not properly fastened down.	Make sure the lamp door is in place and fastened down as shown in the lamp replacement instruction. See page 31.
		The projector has overheated and has automatically shut down.	Allow the projector cool down. Once cooled down, the projector will regain power and the standby button will light up. Clean the projector's air vents as mention the maintenance section.
		The electrical outlet does not have power	Connect the projector to an electric outlet that has power. You can the test the outlet using another electrical appliance to confirm that it has power.
		The projector's power unit has stopped working	Contact 3M for service.

Symptom	Standby Button State	Possible Cause	Action
The lamp will not ignite	Red	The projector is cooling down.	Wait until the projector completes its cooling cycle. Once the Standby button turns amber, you can press the Standby button again.
	Orange	The lamp has expired	Replace the Lamp and press the Standby button to start the projector.
		The lamp ballast may have stopped functioning.	Contact 3M for service.
	Flashes RED once every second	There is a problem with one of the cooling fans.	Follow the maintenance procedure on page 31 and try starting the projector again. If cleaning does not resolve the problem, contact 3M for service.
The lamp will not ignite or has turned off.	Flashes RED twice every second	The projector has overheated due to elevated ambient temperature or altitude, or blocked air vents.	Follow the maintenance procedure on page 31. Unplug the power cord and reconnect and then try again. If cleaning does not resolve the problem, contact 3M for service.
	Flashes RED four times every second	The projector's processor had a communication error due to electromagnetic interference on the communication cable connecting the Control port on the projector and I/O module or poor quality communication cable.	Make sure the cable connecting the Control Port on the projector to the I/O module does not cross power cables or other communication cables. If it does, reroute the cables so that they do not cross. If the communication cable between the projector and the I/O module is longer than 4m (13 ft), consider using the 3M I/O Module Cable Extender P/N: 78-6972-0027-3.

Symptom	Standby Button State	Possible Cause	Action
No image	Green	The desired input source is not selected.	Press the remote control Input button to select a desired input source.
		The cables from the input source are not connected.	Connect the cable to correct input source.
		The input source is not turned on or not displaying an image. (e.g. If a notebook computer, the external monitor port is not turned on).	Turn on input source.
Noise in the image	Green	The video cable adds noise to the signal because it is not properly terminated, too long or lacks adequate electromagnetic shielding.	Shorten the cable between the video source and the system or add a video amplifier between the video source and the long cable.
Noise in the computer image	Green	The projector's Frequency and Phase settings are not properly set.	Adjust Frequency and Phase setting in the Advanced Picture Menu until noise is reduced or eliminated.
No audio from speakers	Green	The projector does not have speakers.	
		The audio cable is connected to the wrong audio input.	Connect the audio cable to correct input source or change audio/video input assignment settings in the projector's Audio menu
		The audio amplified in the 3M Folding Wall Mount is not connected to a power supply.	The I/O Module does not supply power for audio. The power adapter included with the folding wall mount must be connected to the Audio Power port on the bottom of the I/O Module and a cable from the Audio Power port on the top of the I/O Module to the power input on the folding wall mount.
		The audio source or the speakers are muted	Turn off mute on the audio source
The image is dark or dim	Green	The brightness setting is too low.	Adjust the brightness
		The lamp needs to be replaced.	Replace lamp.

Symptom	Standby Button State	Possible Cause	Action
Desired input source cannot be detected		The input source is not active. A signal must be present for the input to be selected.	Connect an active input source to unit.
		The input device (e.g. computer, DVD player, etc.) is not turned on.	Turn on input source.
The remote control does not work		The remote control is not facing the remote control sensor.	Face the remote control toward the remote control sensor.
		The remote control is too far from the sensor	Operate the remote control within 5 meters.
		An obstruction is between the remote control and the sensor.	Remove obstacle.
		The remote control's batteries are exhausted or inserted wrong.	Correctly insert batteries.

Projector Indicator Lights

Mode	Indicator Signal on Projector
Stand by	Orange LED (always ON)
Lamp Strike	Orange LED (Flashing)
Normal Operations	Green LED (always ON)
Fan Error	Red LED (One flash every second) (• • •)
Thermal Error	Red LED (Two flashes every second) (•• ••)
Communication Error	Red LED (Four flashes every second) (•••• •••• ••••)
Cooling (Lock Out)	Red LED (Solid light)

I/O Module Indicator Lights

Mode	Indicator Signals on I/O Model Box
Stand by	Orange LED (always ON)
Normal Operations	Green LED (always ON)
Cooling (Lock Out)	Red LED (Solid light)

Replacement Parts and Accessories

Replacement Parts

Name of Part	3M Part Number
VGA Cable, 1.8 m	78-8134-7029-7
Remote Control	78-8134-7200-4
SCP725/SCP725W Lamp Replacement	78-6969-9996-6

Optional Accessories (not shown)

Name of Part	3M Part Number
3M Fixed Wall Mount SCPFXW.V2	78-6969-9986-7
3M Folding Wall Mount with Speakers SCPWMS.V2	78-6969-9988-3
3M I/O Module V3	78-6972-0012-5
RS232 Adapter for projector control without the I/O Module	78-6969-9934-7
3M Security Kit	78-6969-9961-0
Wall Mount Bracket for Block and Stud Walls	78-6969-9962-8
VGA Cable, 3.5 m (11.5 ft)	78-8134-7218-6
USB Cable, 3.5 m (11.5 ft)	78-8134-7219-4
Control Cable 15 pin DB, 3.5 m (11.5 ft)	78-8134-7220-2

ENGLISH

Important Notice

All statements, technical information, and recommendations related to 3M's products are based on information believed to be reliable, but the accuracy or completeness is not guaranteed. Before using this product, you must evaluate it and determine if it is suitable for your intended application. You assume all risks and liability associated with such use. Any statements related to the product which are not contained in 3M's current publications, or any contrary statements contained on your purchase order shall have no force or effect unless expressly set forth in a written agreement signed by an authorized officer of 3M.

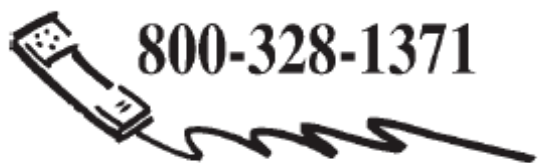
Technical Support Contact:**800-328-1371****<http://www.3m.com/meetings>
e-mail: meetings@mmm.com****3M Austin Center**

Building A145-5N-01
6801 River Place Blvd.
Austin, TX 78726-9000

3M Canada

P.O. box 5757
London, Ontario
N6A 4T1

3M Mexico, S.a. de C.V.

Apartado Postal 14-139
Mexico, D.F. 07000
Mexico

3M Europe

Boulevard de l'Oise
95006 Cerge Pontoise Cedex
France

*Please recycle.*

Litho in USA
@3M 2011