

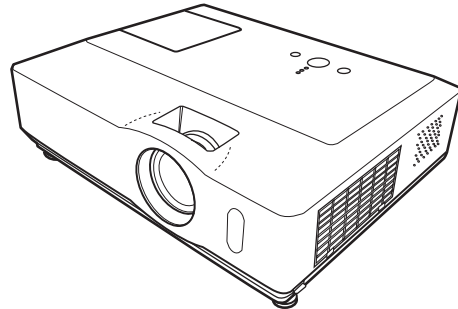

# Digital Projector

## X64

### Operator's Guide



Thank you for purchasing this projector.

**⚠ WARNING** ▶ Before using this product, please read all manuals for this product. Be sure to read "Product Safety Guide" first. After reading them, store them in a safe place for future reference.

#### About this manual

Various symbols are used in this manual. The meanings of these symbols are described below.

**⚠ WARNING** This symbol indicates information that, if ignored, could possibly result in personal injury or even death due to incorrect handling.

**⚠ CAUTION** This symbol indicates information that, if ignored, could possibly result in personal injury or physical damage due to incorrect handling.

 Please refer to the pages written following this symbol.

**NOTE** • The information in this manual is subject to change without notice.

- The manufacturer assumes no responsibility for any errors that may appear in this manual.
- The reproduction, transfer or copy of all or any part of this document is not permitted without express written consent.

#### Trademark acknowledgment

- Mac is registered trademarks of Apple Computer, Inc.
- VESA and SVGA are trademarks of the Video Electronics Standard Association.
- Windows is a registered trademark of Microsoft Corporation.

All other trademarks are the properties of their respective owners.

## Content

## Content

<b>About this manual</b> . . . . .	<b>1</b>		<b>EASY MENU</b> . . . . .	<b>24</b>	
<b>Content</b> . . . . .	<b>2</b>		ASPECT, AUTO KEYSTONE  EXECUTE,		
<b>Projector features</b> . . . . .	<b>3</b>		KEYSTONE  , PICTURE MODE, BRIGHTNESS,		
<b>Preparations</b> . . . . .	<b>3</b>		CONTRAST, COLOR, TINT, SHARPNESS,		
Contents of package . . . . .	3		WHISPER, MIRROR, RESET, FILTER TIME,		
Fastening the lens cover . . . . .	3		LANGUAGE, Go to Advanced Menu...		
<b>Part names</b> . . . . .	<b>4</b>		<b>PICTURE menu</b> . . . . .	<b>26</b>	
Projector . . . . .	4		BRIGHTNESS, CONTRAST, GAMMA, COLOR TEMP,		
Control panel . . . . .	5		COLOR, TINT, SHARPNESS, MY MEMORY		
Rear panel . . . . .	5		<b>IMAGE menu</b> . . . . .	<b>29</b>	
Remote control . . . . .	6		ASPECT, OVER SCAN, V POSITION, H POSITION,		
<b>Setting up</b> . . . . .	<b>7</b>		H PHASE, H SIZE, AUTO ADJUST EXECUTE		
Arrangement . . . . .	7		<b>INPUT menu</b> . . . . .	<b>31</b>	
Connecting your devices . . . . .	10		PROGRESSIVE, VIDEO NR, COLOR SPACE,		
Connecting power supply . . . . .	12		COMPONENT, VIDEO FORMAT,		
Using the security bar and slot . . . . .	12		FRAME LOCK, COMPUTER IN,		
<b>Remote control</b> . . . . .	<b>13</b>		RESOLUTION		
Putting batteries . . . . .	13		<b>SETUP menu</b> . . . . .	<b>34</b>	
About the remote control signal . . . . .	13		AUTO KEYSTONE  EXECUTE, KEYSTONE  ,		
Changing the frequency of remote control signal . . . . .	14		WHISPER, MIRROR, VOLUME,		
Using as a simple PC mouse & keyboard . . . . .	14		SPEAKER, AUDIO		
<b>Power on/off</b> . . . . .	<b>15</b>		<b>SCREEN menu</b> . . . . .	<b>36</b>	
Turning on the power . . . . .	15		LANGUAGE, MENU POSITION, BLANK,		
Turning off the power . . . . .	15		START UP, MyScreen, MyScreen Lock,		
<b>Operating</b> . . . . .	<b>16</b>		MESSAGE, SOURCE NAME		
Adjusting the volume . . . . .	16		<b>OPTION menu</b> . . . . .	<b>40</b>	
Temporarily muting the sound . . . . .	16		AUTO SEARCH, AUTO KEYSTONE  ,		
Selecting an input signal . . . . .	16		AUTO ON, AUTO OFF, LAMP TIME,		
Searching an input signal . . . . .	17		FILTER TIME, MY BUTTON, SERVICE,		
Selecting an aspect ratio . . . . .	17		SECURITY		
Adjusting the projector's elevator . . . . .	18		<b>Maintenance</b> . . . . .	<b>51</b>	
Adjusting the zoom and focus . . . . .	18		Lamp . . . . .	51	
Using the automatic adjustment feature . . . . .	19		Air filter . . . . .	53	
Adjusting the position . . . . .	19		Other care . . . . .	54	
Correcting the keystone distortions . . . . .	20		<b>Troubleshooting</b> . . . . .	<b>55</b>	
Using the magnify feature . . . . .	20		Related messages . . . . .	55	
Freezing the screen . . . . .	21		Regarding the indicator lamps . . . . .	56	
Temporarily blanking the screen . . . . .	21		Shutting the projector down . . . . .	57	
Using the menu function . . . . .	22		Resetting all settings . . . . .	57	
			Phenomena that may be easy to be mistaken for machine defects . . . . .	58	
			<b>Specifications</b> . . . . .	<b>60</b>	

**Technical (English only)**

(Please see the end of this book, although only in English.)

## Projector features

This projector has a capability to project various picture signals onto a screen. This projector requires only a minimal amount of space for installation and can produce a large projected image from even a short distance. This projector boasts a variety of I/O ports and low noise. These features provide you with the broad use of this projector.

## Preparations

### Contents of package

Your projector should come with the items shown below. Contact immediately your dealer if anything is missing.

**NOTE** • Keep the original packing materials for future reshipment. For moving the projector, be sure to use the original packing materials. Use special caution for the lens part.

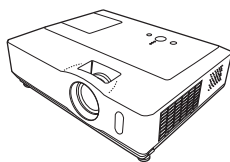

Projector

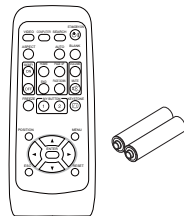
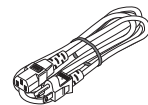
Remote control  
(with two AA batteries)

Power cord

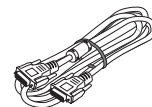

VGA cable

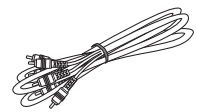
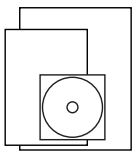
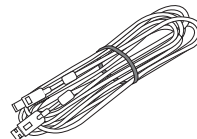
RCA  
Video/Audio cableOperator's Guide  
Product Safety Guide  
Quick Start Guide  
Warranty and  
Warranty Registration  
WEEE Statement

USB cable

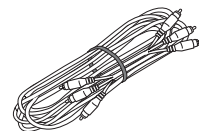
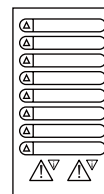
RCA  
Component cableLens cover and Strap  
Lens cover is attached to  
the projector.

Security Label

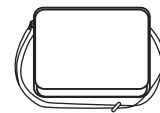

Soft case

### Fastening the lens cover

To avoid losing the lens cover, please fasten the lens cover to the projector using the enclosed strap.

1. Fix the strap to the strap hole of the lens cover.
  - Thread one end of the strap through the strap hole of the lens cover and make the loop at the end, and let the other end of the strap through the loop. Not have a knot in the strap at either end.
2. Fix the strap to the strap hole of the projector.
  - Thread the other end of the strap through the strap hole of the projector and make the loop there. Let the lens cover with the one end of strap through the loop.

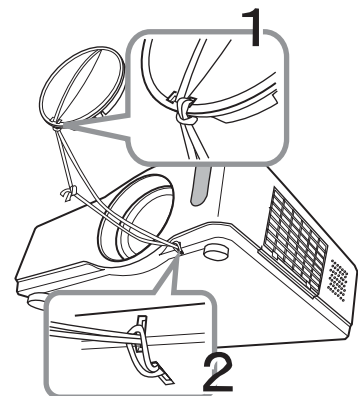

## Part names

## Part names

## Projector

- (1) Lamp door (📖51)  
The lamp unit is inside.
- (2) Focus ring (📖18)
- (3) Zoom ring (📖18)
- (4) Control panel (📖5)
- (5) Elevator buttons (x 2) (📖18)
- (6) Elevator feet (x 2) (📖18)
- (7) Remote sensor (📖13)
- (8) Lens (📖18, 54)
- (9) Lens cover (📖3)
- (10) Intake vents
- (11) Filter cover (📖53)  
The air filter and intake vent are inside.
- (12) Speaker (📖35)
- (13) Exhaust vent
- (14) AC inlet (📖12)
- (15) Power switch (📖15)
- (16) Rear panel (📖5)
- (17) Security bar (📖12)
- (18) Security slot (📖12)

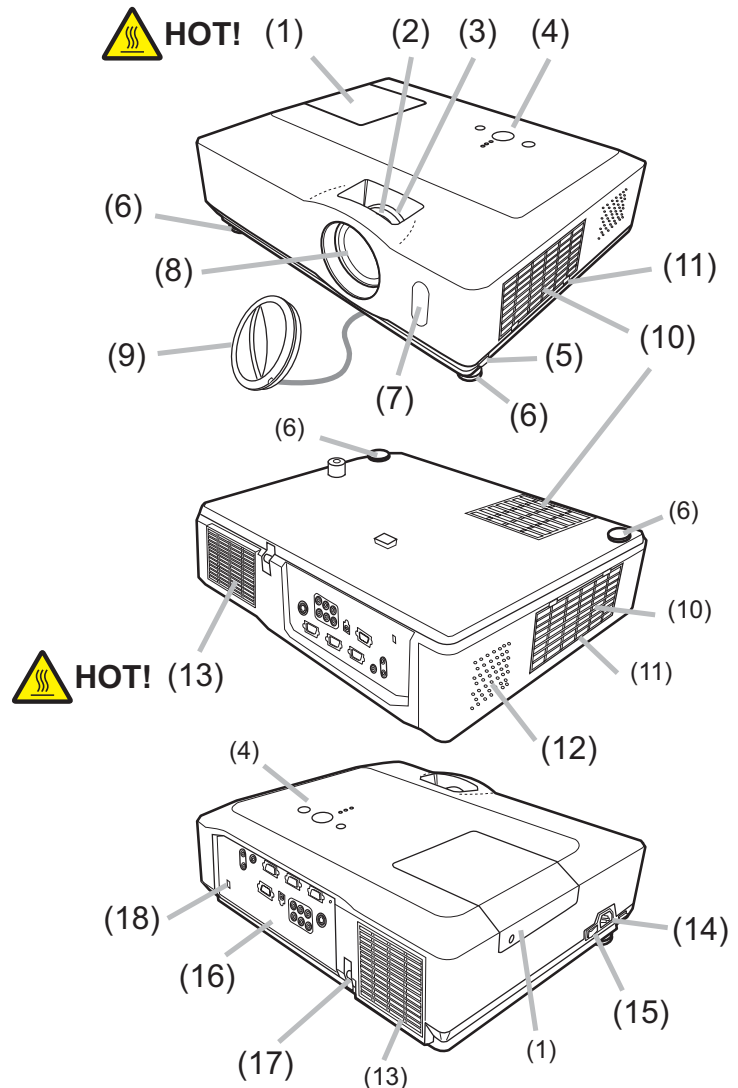

**⚠️ WARNING ► HOT! :** Do not touch around the lamp door and the exhaust vents during use or just after use, since it is too hot.

**⚠️ CAUTION ►** Maintain normal ventilation to prevent the projector from heating up. Do not cover, block or plug up the vents. Do not place anything that can stick or be sucked to the vents, around the intake vents. Clean the air filter periodically.

► Do not handle the elevator buttons without holding the projector, since the projector may drop down.

► Do not look into the lens or vents while the lamp is on, since the strong light is not good for your eyes.

## Control panel

- (1) STANDBY/ON button (📖15)
- (2) INPUT button (📖16, 22)
- (3) MENU button (📖22)

It consists of four cursor buttons.

- (4) POWER indicator (📖15, 56)
- (5) TEMP indicator (📖56)
- (6) LAMP indicator (📖56)

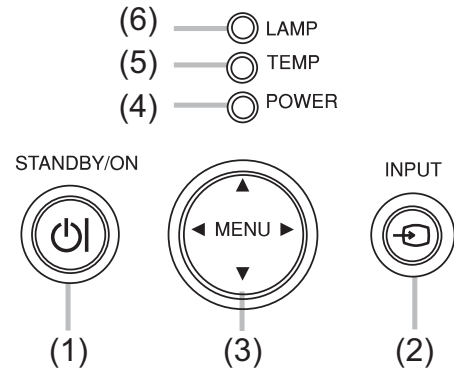

## Rear panel

- (1) AUDIO IN1 port (📖10)
- (2) AUDIO IN2 port (📖10)
- (3) AUDIO OUT port (📖10)
- (4) COMPUTER IN1 port (📖10)
- (5) COMPUTER IN2 port (📖10)
- (6) MONITOR OUT port (📖10)
- (7) Shutdown switch (📖57)
- (8) CONTROL port (📖10)
- (9) USB port (📖10)
- (10) COMPONENT (Y, Cb/Pb, Cr/Pr) port (📖10)
- (11) VIDEO port (📖10)
- (12) S-VIDEO port (📖10)
- (13) AUDIO IN3 (L,R) ports (📖10)

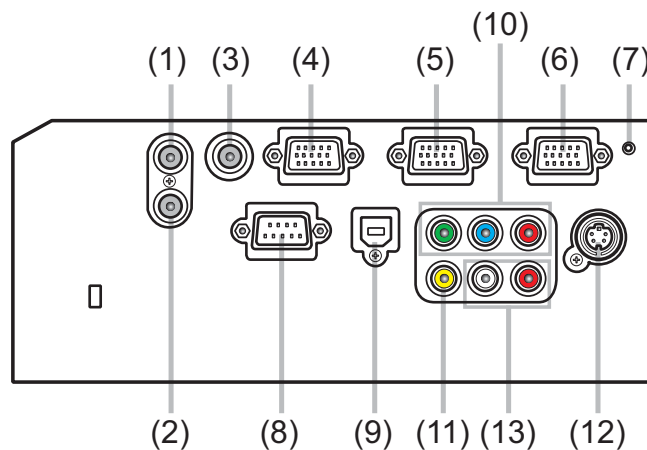

**⚠ CAUTION** ▶ Do not use the security bar and slot to prevent the projector from falling down, since it is not designed for it.

▶ Use the shutdown switch only when the projector is not turned off by normal procedure, since pushing this switch stops operation of the projector without cooling it down.

## Part names

## Remote control

- (1) VIDEO button (📖17)
- (2) COMPUTER button (📖16)
- (3) SEARCH button (📖17)
- (4) STANDBY/ON button (📖15)
- (5) ASPECT button (📖17)
- (6) AUTO button (📖19)
- (7) BLANK button (📖21)
- (8) MAGNIFY - ON button (📖20)
- (9) MAGNIFY - OFF button (📖14, 20)
- (10) HOME button (📖14)
- (11) END button (📖14)
- (12) PAGE UP button (📖14)
- (13) PAGE DOWN button (📖14)
- (14) VOLUME button (📖16)
- (15) MUTE button (📖14, 16)
- (16) FREEZE button (📖21)
- (17) MY BUTTON - 1 button (📖42)
- (18) MY BUTTON - 2 button (📖42)
- (19) KEYSTONE button (📖20)
- (20) POSITION button (📖19, 22)
- (21) MENU button (📖22)
- (22) ▲/▼/◀/▶ cursor buttons (📖14, 22, 23)
- (23) ENTER button (📖14, 22, 23)
- (24) ESC button (📖14, 22)
- (25) RESET button (📖14, 22, 23)
- (26) Battery cover (📖13)

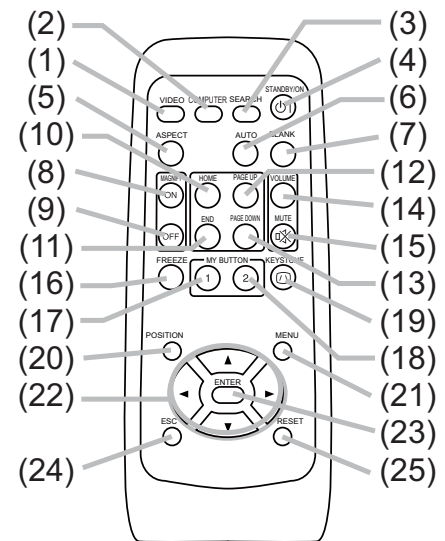

Back of  
the remote control

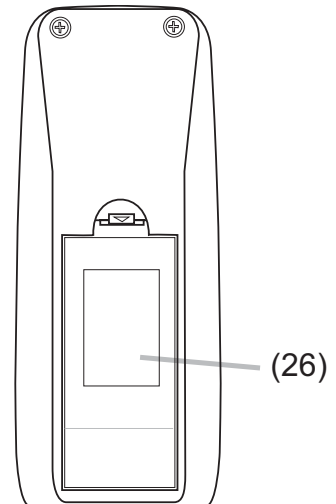

## Setting up

Install the projector according to the environment and manner the projector will be used in.

### Arrangement

Refer to the illustrations and tables below to determine screen size and projection distance.

The values shown in the table are calculated for a full size screen: 1024×768.

- (a) Screen size (diagonal)
- (b) Projection distance (±10%)
- (c1), (c2) Screen height (±10%)

#### On a horizontal surface

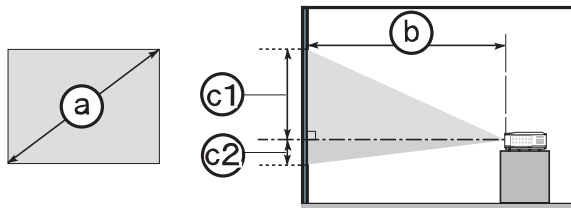

#### Suspended from the ceiling

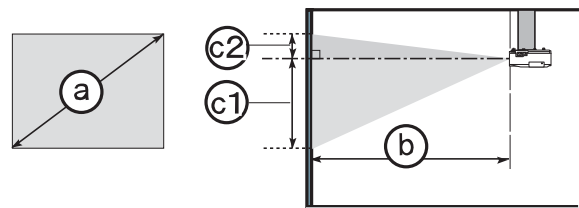

Ⓐ Screen size (diagonal)		4 : 3 screen								16 : 9 screen							
		Ⓑ Projection distance				Ⓒ1 Screen height		Ⓒ2 Screen height		Ⓑ Projection distance				Ⓒ1 Screen height		Ⓒ2 Screen height	
		min.		max.						min.		max.					
inch	m	m	inch	m	inch	cm	inch	cm	inch	m	inch	m	inch	cm	inch	cm	inch
30	0.8	0.9	35	1.1	43	41	16	5	2	1.0	39	1.2	47	39	15	-1	0
40	1.0	1.2	47	1.4	57	55	22	6	2	1.3	52	1.6	62	51	20	-2	-1
50	1.3	1.5	59	1.8	71	69	27	8	3	1.6	65	2.0	78	64	25	-2	-1
60	1.5	1.8	71	2.2	86	82	32	9	4	2.0	78	2.4	94	77	30	-2	-1
70	1.8	2.1	83	2.5	100	96	38	11	4	2.3	91	2.8	109	90	35	-3	-1
80	2.0	2.4	95	2.9	115	110	43	12	5	2.6	104	3.2	125	103	41	-3	-1
90	2.3	2.7	107	3.3	129	123	49	14	5	3.0	117	3.6	141	116	46	-4	-1
100	2.5	3.0	119	3.6	144	137	54	15	6	3.3	130	4.0	156	129	51	-4	-2
120	3.0	3.6	143	4.4	172	165	65	18	7	4.0	156	4.8	188	154	61	-5	-2
150	3.8	4.6	179	5.5	216	206	81	23	9	4.9	195	6.0	235	193	76	-6	-2
200	5.1	6.1	239	7.3	288	274	108	30	12	6.6	261	8.0	314	257	101	-8	-3
250	6.4	7.6	299	9.1	360	343	135	38	15	8.3	326	10.0	392	322	127	-10	-4
300	7.6	9.1	359	11.0	432	411	162	46	18	9.9	391	12.0	471	386	152	-12	-5

## Setting up

### Arrangement (continued)

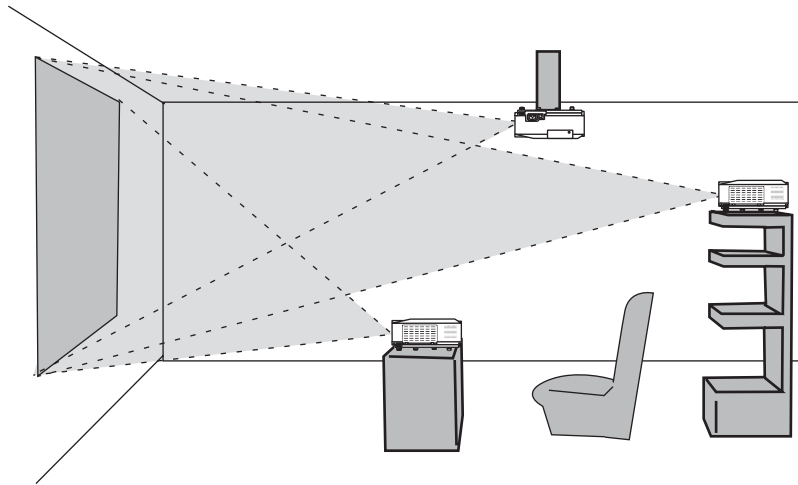

- Keep a space of 30 cm or more between the sides of the projector and other objects such as walls.
- Consult with your dealer before a special installation such as suspending from a ceiling.



**⚠ WARNING** ► Place the projector in a stable horizontal position. If the projector falls or is knocked over it could cause injury and/or damage to the projector. Using a damaged projector could then result in fire and/or electric shock.

- Do not place the projector on an unstable, slanted or vibrational surface such as a wobbly or inclined stand.
- Do not place the projector on its side, front or rear position.
- Consult with your dealer before a special installation such as suspending from a ceiling.

► Place the projector in a cool place, and ensure that there is sufficient ventilation. The high temperature of the projector could cause fire, burns and/or malfunction of the projector.

- Do not stop-up, block or otherwise cover the projector's vents.
- Keep a space of 30 cm or more between the sides of the projector and other objects such as walls.
- Do not place the projector on metallic thing or anything weak in heat.
- Do not place the projector on carpet, cushions or bedding.
- Do not place the projector in direct sunlight or near hot objects such as heaters.
- Do not anything near the projector lens or vents, or on top of the projector.
- Do not place anything that may be sucked into or stick to the vents on the bottom of the projector. This projector has some intake vents also on the bottom.

► Do not place the projector anyplace where it may get wet. Getting the projector wet or inserting liquid into the projector could cause fire, electric shock and/or malfunction of the projector.

- Do not place the projector in a bathroom or the outdoors.
- Do not place anything containing liquid near the projector.

**⚠ CAUTION** ► Avoid placing the projector in smoky, humid or dusty place. Placing the projector in such places could cause fire, electric shock and/or malfunction of the projector.

- Do not place the projector near humidifiers, smoking spaces or a kitchen.
- Position the projector to prevent light from directly hitting the projector's remote sensor.

## Setting up

### Connecting your devices

Be sure to read the manuals for devices before connecting them to the projector. Make sure that all the devices are suitable to be connected with this product, and prepare the cables required to connect.

Please refer to the following illustrations to connect them.

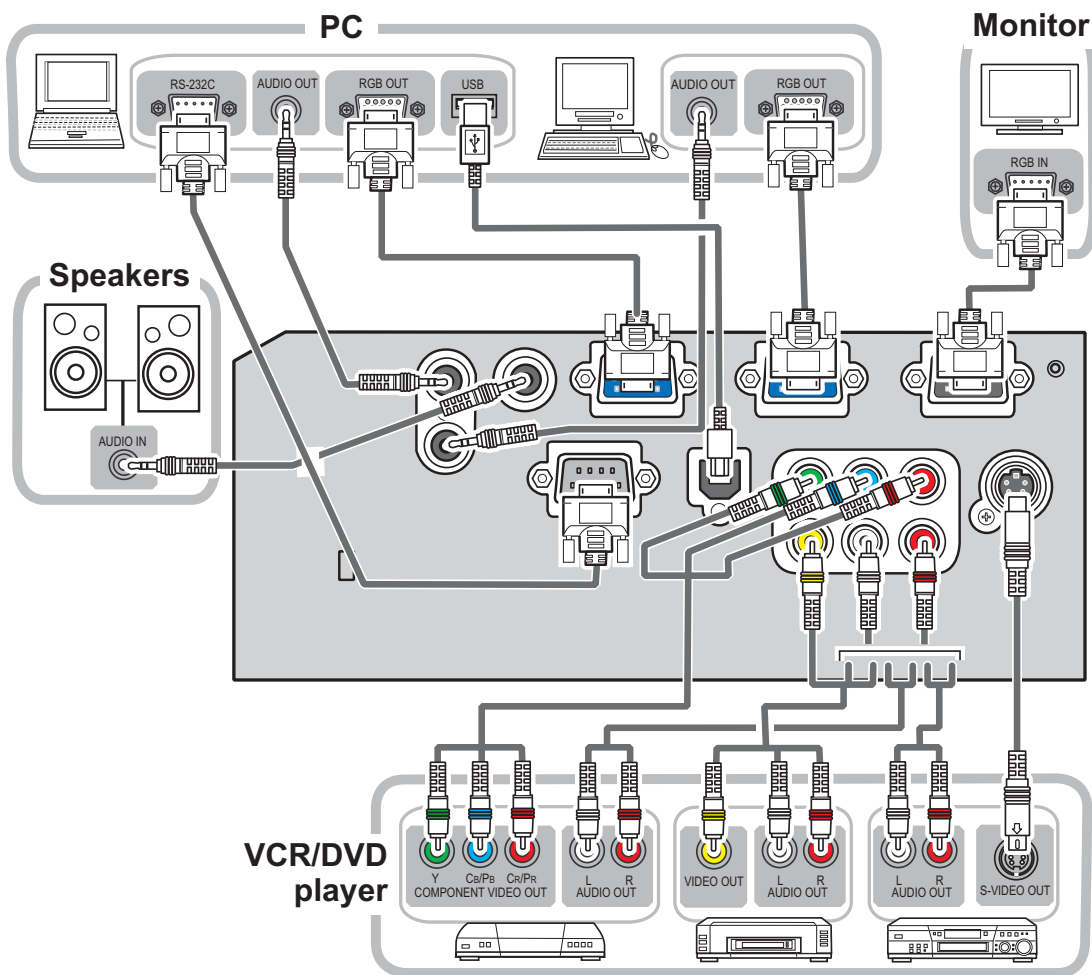

**⚠ WARNING** ► Do not disassemble or modify the projector and accessories.

► Be careful not to damage the cables, and do not use damaged cables.

**⚠ CAUTION** ► Turn off all devices and unplug their power cords prior to connecting them to projector. Connecting a live device to the projector may generate extremely loud noises or other abnormalities that may result in malfunction or damage to the device and the projector.

► Use appropriate accessory or otherwise designed cables. Ask your dealer about non-accessory cables which may have to be of a specific length or equipped with a core. For cables with a core only at one end, connect the end with the core to the projector.

► Make sure that devices are connected to the correct ports. An incorrect connection may result in malfunction or damage to the device and the projector.

## Connecting your devices (continued)

**NOTE** • Be sure to read the manuals for devices before connecting them to the projector, and make sure that all the devices are suitable to be connected with this product. Before connecting to a PC, check the signal level, the signal timing, and the resolution.

- Some signal may need an adapter to input this projector.
- Some PCs have multiple screen display modes that may include some signals which are not supported by this projector.
- Although the projector can display signals with resolution up to UXGA (1600X1200), the signal will be converted to the projector's panel resolution before being displayed. The best display performance will be achieved if the resolutions of the input signal and the projector panel are identical.
- While connecting, make sure that the shape of the cable's connector fits the port to connect with. And be sure to tighten the screws on connectors with screws.
- When connecting a laptop PC to the projector, be sure to activate the PC's external RGB output. (Set the laptop PC to CRT display or to simultaneous LCD and CRT display.) For details on how this is done, please refer to the instruction manual of the corresponding laptop PC.
- When the picture resolution is changed on a pc depending on an input, automatic adjustment function may take some time and may not be completed. In this case, you may not be able to see a check box to select "Yes/No" for the new resolution on Windows. Then the resolution will go back to the original. It might be recommended to use other CRT or LCD monitors to change the resolution.
- In some cases, this projector may not display a proper picture or display any picture on screen. For example, automatic adjustment may not function correctly with some input signals. An input signal of composite sync or sync on G may confuse this projector, so the projector may not display a proper picture.

### **About Plug-and-Play capability**

Plug-and-Play is a system composed of a PC, its operating system and peripheral equipment (i.e. display devices). This projector is VESA DDC 2B compatible. Plug-and-Play can be used by connecting this projector to a pc that is VESA DDC (display data channel) compatible.

- Take advantage of this feature by connecting an RGB cable to the COMPUTER IN1 port (DDC 2B compatible). Plug-and-Play may not work properly if any other type of connection is attempted.
- Please use the standard drivers in your pc as this projector is a Plug-and-Play monitor.

## Setting up

### Connecting power supply

At first, make sure that the power switch of the projector is set to OFF position (marked "O").

1. Put the connector of the power cord into the AC inlet of the projector.
2. Firmly plug the power cord's plug into the outlet.

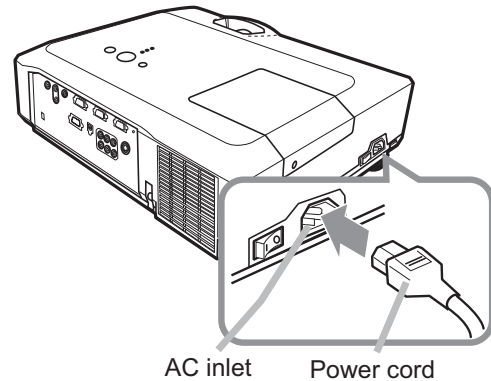

**⚠ WARNING** ► Please use extra caution when connecting the power cord, as incorrect or faulty connections may result in fire and/or electrical shock.

- Only use the power cord that came with the projector. If it is damaged, contact your dealer to newly get correct one.
- Only plug the power cord into an outlet rated for use with the power cord's specified voltage range. The power outlet should be close to the projector and easily accessible. Remove the power cord for complete separation.
- Never modify the power cord.

### Using the security bar and slot

A commercial anti-theft chain or wire up to 10 mm in diameter can be attached to the security bar on the projector.

Also this product has the security slot for the Kensington lock.

For details, see the manual of the security tool.

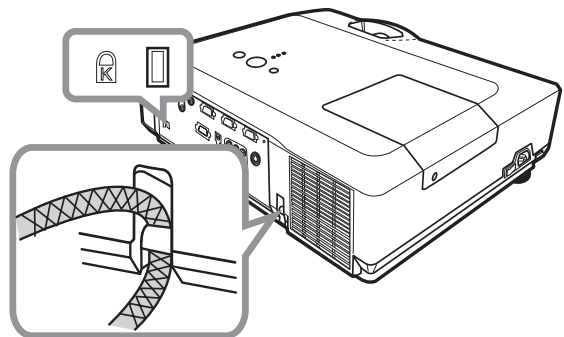

**⚠ CAUTION** ► Do not use the security bar and slot to prevent the projector from falling down, since it is not designed for it.

► Do not place anti-theft chain or wire near the exhaust vents. It may become too hot.

**NOTE** • The security bar and slot is not comprehensive theft prevention measures. It is intended to be used as supplemental theft prevention measure.

## Remote control

### Putting batteries

Please set the batteries to the remote control before using it. If the remote control starts to malfunction, try to replace the batteries. If you will not use the remote control for long period, remove the batteries from the remote control and store them in a safe place.

1. Holding the hook part of the battery cover, remove it.
2. Align and insert the two AA batteries according to their plus and minus terminals as indicated in the remote control.
3. Replace the battery cover in the direction of the arrow and snap it back into place.

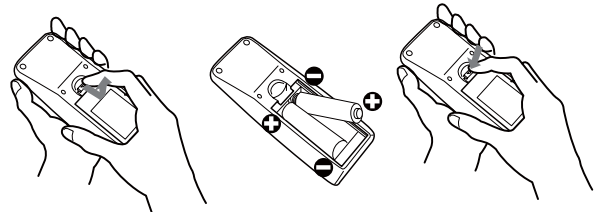

**⚠ WARNING** ► Always handle the batteries with care and use them only as directed. Improper use may result in battery explosion, cracking or leakage, which could result in fire, injury and/or pollution of the surrounding environment.

- Be sure to use only the batteries specified. Do not use batteries of different types at the same time. Do not mix a new battery with used one.
- Make sure the plus and minus terminals are correctly aligned when loading a battery.
- Keep a battery away from children and pets.
- Do not recharge, short circuit, solder or disassemble a battery.
- Do not allow a battery in a fire or water. Keep batteries in a dark, cool and dry place.
- If you observe battery leakage, wipe out the leakage and then replace a battery. If the leakage adheres to your body or clothes, rinse well with water immediately.
- Obey the local laws on disposing the battery.

### About the remote control signal

The remote control works with the projector's remote sensor. This projector has a remote sensor on the front.

The sensor senses the signal within the following range when the sensor is active:

60 degrees (30 degrees to the left and right of the sensor) within 3 meters about.

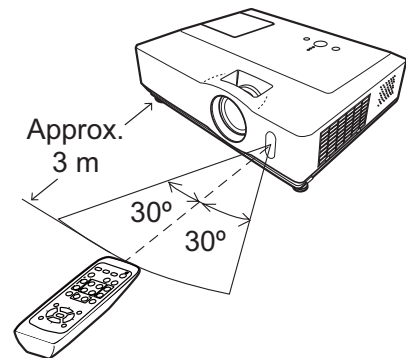

**NOTE** • The remote control signal reflected in the screen or the like may be available. If it is difficult to send the signal to the sensor directly, attempt to make the signal reflect.

- The remote control uses infrared light to send signals to the projector (Class 1 LED), so be sure to use the remote control in an area free from obstacles that could block the remote control's signal to the projector.
- The remote control may not work correctly if strong light (such as direct sun light) or light from an extremely close range (such as from an inverter fluorescent lamp) shines on the remote sensor of the projector. Adjust the position of projector avoiding those lights.

## Remote control

### Changing the frequency of remote control signal

The accessory remote control has the two choices on signal frequency Mode 1:NORMAL and Mode 2:HIGH. If the remote control does not function properly, attempt to change the signal frequency.

In order to set the Mode, please keep pressing the combination of two buttons listed below simultaneously for about 3 seconds.

(1) Set to Mode 1:NORMAL... MUTE and RESET buttons

(2) Set to Mode 2:HIGH... MAGNIFY OFF and ESC buttons

Please remember that the REMOTE FREQ. in the SERVICE item of the OPTION menu (  44) of the projector to be controlled should be set to the same mode as the remote control.

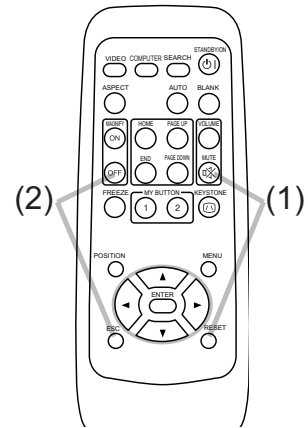

### Using as a simple PC mouse & keyboard

The enclosed remote control works as a simple mouse and keyboard of the PC, when the projector's USB port (B type) connects with the PC's USB port (A type) port via a mouse cable.

- (1) **HOME key:** Press HOME button.
- (2) **END key:** Press END button.
- (3) **PAGE UP key:** Press PAGE UP button.
- (4) **PAGE DOWN key:** Press PAGE DOWN button.
- (5) **Mouse left button:** Press ENTER button.
- (6) **Move pointer:** Use the cursor buttons ▲, ▼, ◀ and ▶.
- (7) **ESC key:** Press ESC button.
- (8) **Mouse right button:** Press RESET button.

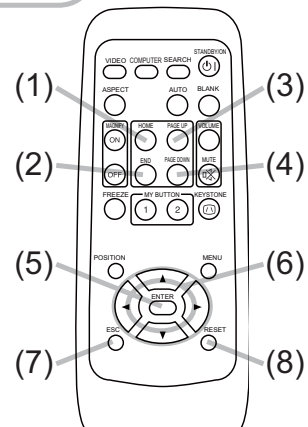
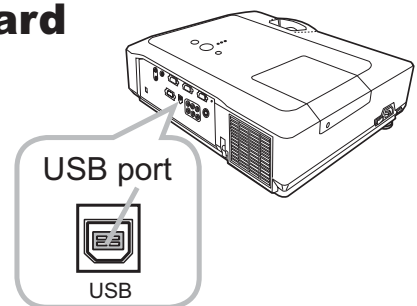

**⚠ CAUTION** ▶ Improper use of the simple mouse & keyboard function could damage your equipment. While using this function, please connect this product only to a PC. Be sure to check your PC's manuals before connecting this product to the PC.

**NOTE** • When the simple mouse & keyboard function of this product does not work correctly, please check the following.

- When the mouse cable connects this projector with a PC having a built-in pointing device (e.g. track ball) like a notebook PC, open BIOS setup menu, then select the external mouse and disable the built-in pointing device, because the built-in pointing device may have priority to this function.
- Windows 95 OSR 2.1 or higher is required for this function. And also this function may not work depending on the PC's configurations and mouse drivers.
- You cannot do things like press two buttons at once (for instance, pressing two buttons at the same time to move the mouse pointer diagonally).
- This function is activated only when the projector is working properly. This function is not available while the lamp is warming up (the POWER indicator blinks green), and while adjusting the volume and display, correcting for keystone, zooming in on the screen, using the BLANK function, or displaying the menu screen.

## Power on/off

### Turning on the power

1. Make sure that the power cord is firmly and correctly connected to the projector and the outlet.
2. Remove the lens cover, and set the power switch to ON position (marked "I").  
The POWER indicator will light up in steady orange (📖56). Then wait several seconds because the buttons may not function for these several seconds.
3. Press STANDBY/ON button on the projector or the remote control.  
The projection lamp will light up and POWER indicator will begin blinking in green. When the power is completely on, the indicator will stop blinking and light in steady green (📖56).

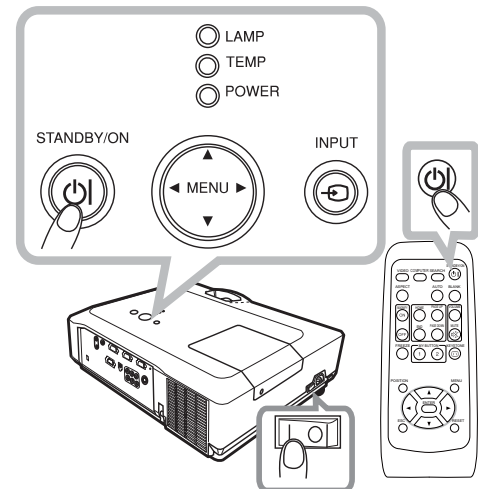

To display the picture, select an input signal according to the section "Selecting an input signal" (📖16).

### Turning off the power

1. Press the STANDBY/ON button on the projector or the remote control. The message "Power off?" will appear on the screen for about 5 seconds.
2. Press the STANDBY/ON button again while the message appears.  
The projector lamp will go off, and the POWER indicator will begin blinking in orange. Then POWER indicator will stop blinking and light in steady orange when the lamp cooling is complete(📖56).
3. Make sure that POWER indicator lights in steady orange, and set the power switch to OFF position (marked "O").  
POWER indicator will go off. Attach the lens cover.



Do not turn the projector on for about 10 minutes or more after turning it off. Turning the projector on again too soon could shorten the lifetime of some consumable parts of the projector.

**⚠ CAUTION** ▶ A strong light is emitted when the projector's power is on. Do not look into the lens of the projector or look inside of the projector through any of the projector's openings.  
▶ Do not touch around the lamp door and the exhaust vents during use or just after use, since it is too hot.

**NOTE** • Turn the power on/off in right order. Please power on the projector prior to the connected devices. Power off the projector after all of connected devices are powered off.  
• The projector has the AUTO ON function, which can make the projector automatically turn on. For more information, please see AUTO ON item of OPTION menu (📖40).  
• Use the shutdown switch (📖57) only when the projector is not turned off by normal procedure.

**Operating**

**Operating**

**Adjusting the volume**

1. Press VOLUME button on the remote control.
    - A dialog will appear on the screen to aid you in adjusting the volume.
  2. Use the ▲/▼ cursor buttons to adjust the volume.
    - To close the dialog and complete the operation, press the VOLUME button again. Even if you do not do anything, the dialog will automatically disappear after a few seconds.
- When ~~X~~ is selected for current picture input port, the volume adjustment is disable. Please see AUDIO item of SETUP menu (📖35).

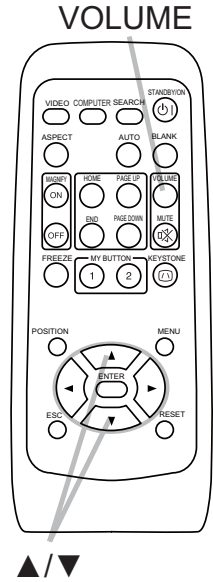

**Temporarily muting the sound**

1. Press MUTE button on the remote control.
    - A dialog will appear on the screen indicating that you have muted the sound. To restore the sound, press the MUTE or VOLUME button. Even if you do not do anything, the dialog will automatically disappear after a few seconds.
- When ~~X~~ is selected for current picture input port, the sound is always muted. Please see AUDIO item of SETUP menu (📖35).

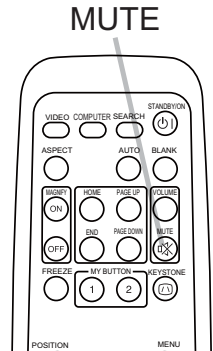

**Selecting an input signal**

1. Press INPUT button on the projector.
  - Each time you press the button, the projector switches its input port as below.



1. Press COMPUTER button on the remote control.
  - Each time you press the button, the projector switches its input port as below.

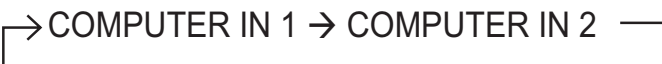

- If COMPUTER button is pushed to switch from a signal from VIDEO, S-VIDEO or COMPONENT port, when TURN ON is selected for AUTO SEARCH item in OPTION menu (📖40), the projector will check COMPUTER IN1 port first. If no input is detected at the port, the projector will check COMPUTER IN2 port.

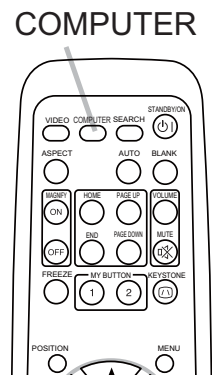
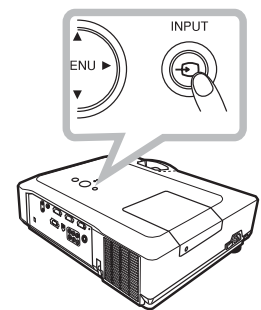

(continued on next page)



## Selecting an input signal (continued)

- Press VIDEO button on the remote control.
  - Each time you press the button, the projector switches its input port as below.

→ COMPONENT(Y, Cb/Pb, Cr/Pr) → S-VIDEO → VIDEO →

- If VIDEO button is pushed to switch from a signal from COMPUTER IN1 or 2 port, when TURN ON is selected for AUTO SEARCH item in OPTION menu (40), the projector will check COMPONENT port first. If no input is detected at the port, the projector will check the other port in above order.

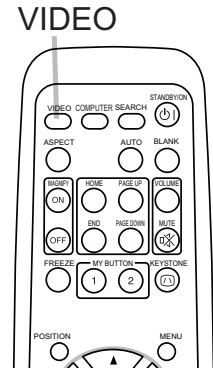

## Searching an input signal

- Press SEARCH button on the remote control.
  - The projector will start to check its input ports in order to find any input signals. When an input is found, the projector will stop searching and display the image. If no signal is found, the projector will return to the state selected before the operation.

→ COMPUTER IN 1 → COMPUTER IN 2 →  
VIDEO ← S-VIDEO ← COMPONENT (Y, Cb/Pb, Cr/Pr) ←

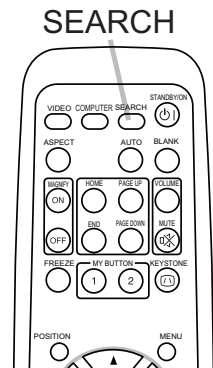

## Selecting an aspect ratio

- Press ASPECT button on the remote control.
    - Each time you press the button, the projector switches the mode for aspect ratio in turn.
      - For a computer signal**  
NORMAL → 4:3 → 16:9 → SMALL
      - For a video signal, s-video signal or component video signal**  
4:3 → 16:9 → 14:9 → SMALL
      - For no signal**  
4:3 (fixed)
- ASPECT button does not work when no proper signal is inputted.
  - NORMAL mode keeps the original aspect ratio setting.

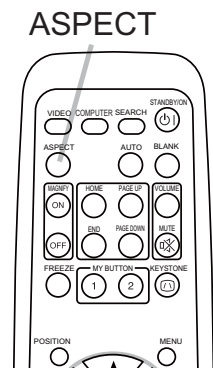

## Operating

### Adjusting the projector's elevator

When the place to put the projector is slightly uneven to the left or right, use the elevator feet to place the projector horizontally.

Using the feet can also tilt the projector in order to project at a suitable angle to the screen, elevating the front side of the projector within 10 degrees.

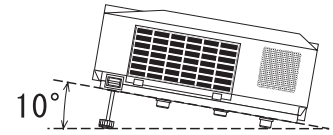

This projector has 2 elevator feet and 2 elevator buttons. An elevator foot is adjustable while pushing the elevator button on the same side as it.

1. Holding the projector, push the elevator buttons to loose the elevator feet.
2. Position the front side of the projector to the desired height.
3. Release the elevator buttons in order to lock the elevator feet.
4. After making sure that the elevator feet are locked, put the projector gently.
5. If necessary, the elevator feet can be manually twisted to make more precise adjustments. Hold the projector when twisting the feet.

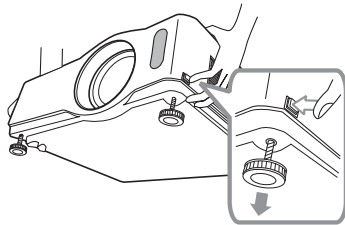

To loose an elevator foot, push the elevator button on the same side as it.

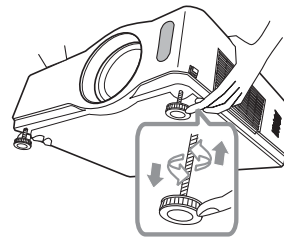

To finely adjust, twist the foot.

**⚠ CAUTION** ▶ Do not handle the elevator buttons without holding the projector, since the projector may drop down.

▶ Do not tilt the projector other than it elevating its front within 10 degrees using the adjuster feet. A tilt of the projector exceeding the restriction could cause malfunction or shortening the lifetime of consumables, or the projector itself.

### Adjusting the zoom and focus

1. Use the zoom ring to adjust the screen size.
2. Use the focus ring to focus the picture.

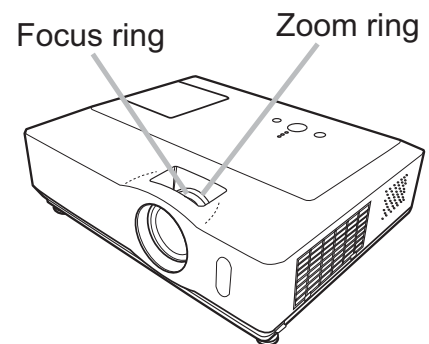

## Using the automatic adjustment feature

1. Press AUTO button on the remote control.
  - Pressing this button performs the following.

- **For a computer signal**

The vertical position, the horizontal position and the horizontal phase will be automatically adjusted. And the horizontal size will be automatically set to the default.

Make sure that the application window is set to its maximum size prior to attempting to use this feature. A dark picture may still be incorrectly adjusted. Use a bright picture when adjusting.

- **For a video signal, s-video signal or component video signal**

The video format best suited for the respective input signal will be selected automatically. This function is available only when AUTO is selected for VIDEO FORMAT item in INPUT menu (📖32).

The vertical position and horizontal position will be automatically set to the default. For a component video signal, also the horizontal phase will be automatically set to the default.

- The automatic adjustment operation requires several seconds. Also please note that it may not function correctly with some input. When this function is performed for a video signal, a certain extra such as a line may appear outside a picture.
- The items adjusted by this function may vary when FINE or DISABLE is selected for AUTO ADJUST item of SERVICE item in OPTION menu (📖43).

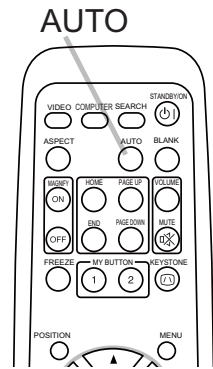

## Adjusting the position

1. Press POSITION button on the remote control when no menu is indicated.

The “POSITION” indication will appear on the screen.

2. Use the ▲/▼/◀/▶ cursor buttons to adjust the picture position.

When you want to reset the operation, press RESET button on the remote control during the operation.

To complete this operation, press POSITION button again. Even if you do not do anything, the dialog will automatically disappear after a few seconds.

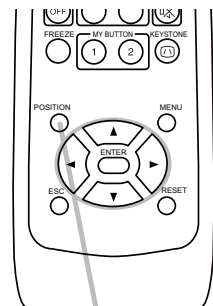

POSITION

- When this function is performed on a video signal, s-video signal or component video signal, some image such as an extra-line may appear at outside of the picture.
- When this function is performed on a video signal, s-video signal or component video signal, the range of this adjustment depends on OVER SCAN in IMAGE menu (📖29) setting. It is not possible to adjust when OVER SCAN is set to 10.
- If POSITION button is pressed when a menu is indicated on screen, the displayed picture does not move its position but the menu does.

## Operating

### Correcting the keystone distortions

1. Press KEYSTONE button on the remote control. A dialog will appear on the screen to aid you in correcting the distortion.
2. Use the ▲/▼ cursor buttons to select AUTO or MANUAL operation, and press the ► button to perform the following.
  - (1) AUTO executes automatic vertical keystone correction.
  - (2) MANUAL displays a dialog for keystone correction. Use the ▲/▼ buttons for adjustment.

To close the dialog and complete this operation, press KEYSTONE button again. Even if you do not do anything, the dialog will automatically disappear after a few seconds.

- The adjustable range of this correction will vary among inputs. For some input, this function may not work well.
- When V:INVERT or H&V:INVERT is selected for MIRROR item in SETUP menu, if the projector screen is inclined or angled downward, this function may not work correctly.
- When the zoom adjustment is set to TELE (telephoto focus), the automatic keystone distortion correction may be excessive. This function should be used when the zoom adjustment is set to the full WIDE (wide-angle focus) whenever possible.
- When the projector is placed on the level (about  $\pm 0^\circ$ ), the automatic keystone distortion correction may not work.
- When the projector is inclined to near  $\pm 30$  degree or over, this function may not work well.
- This function will be unavailable when Transition Detector is on (📖 49).

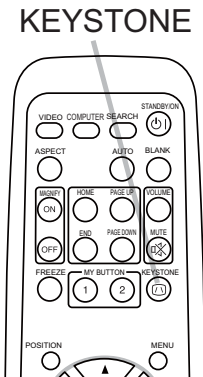

### Using the magnify feature

1. Press the ON button of MAGNIFY on the remote control.
  - The “MAGNIFY” indication will appear on the screen and the projector will go into the MAGNIFY mode. The indication will disappear in several seconds with no operation.
2. Use the ▲/▼ cursor buttons to adjust the zoom level. To move the zoom area, press POSITION button in the MAGNIFY mode, then use the ▲/▼/◀/▶ cursor buttons to move the area. And to finalize the zoom area, press POSITION button again.

To exit from the MAGNIFY mode and restore the screen to normal, press the OFF button of MAGNIFY on the remote control.

- The projector automatically exits from the MAGNIFY mode when the input signal is changed or when the display condition is changed.
- In the MAGNIFY mode, the keystone distortion condition may vary, it will be restored when the projector exits from the MAGNIFY mode.

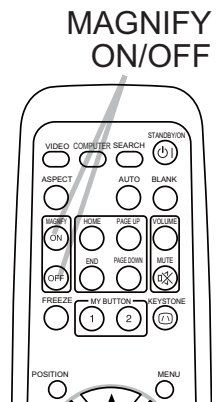

**NOTE** • The zoom level can be finely adjusted. Closely watch the screen to find the level you want.

## Freezing the screen

- 1 Press FREEZE button on the remote control.
    - The “FREEZE” indication will appear on the screen (however, the indication will not appear when TURN OFF is selected for MESSAGE item in SCREEN menu (📖39)), and the projector will go into the FREEZE mode.
- To exit the FREEZE mode and restore the screen to normal, press FREEZE button again.

- The projector automatically exits from the FREEZE mode when one of the projector’s buttons or remote control buttons of STANDBY/ON, SEARCH, COMPUTER, VIDEO, BLANK, AUTO, VOLUME, MUTE, KEYSTONE, MENU, MAGNIFY and MY BUTTON1/2(except MY MEMORY or PICTURE MODE is assigned to) (📖42) is pressed.
- If the projector continues projecting a still image for a long time, the LCD panel might possibly be burned in. Do not leave the projector in the FREEZE mode for too long.

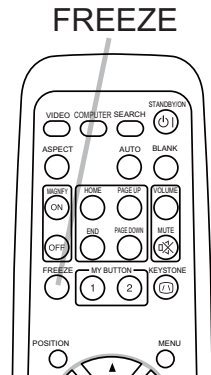

## Temporarily blanking the screen

- 1 Press BLANK button on the remote control.
  - The blank screen will be displayed instead of the screen of input signal. Please refer to BLANK item in SCREEN menu (📖36).

To exit from the blank screen and return to the input signal screen, press BLANK button again.

- The projector automatically returns to the input signal screen when one of the projector’s buttons or the remote control buttons (except ASPECT, POSITION, MAGNIFY or FREEZE button, also except MY BUTTON1/2 if AUTO KEYSTONE [▽] EXECUTE or MY MEMORY or PICTURE MODE is assigned to (📖42)) is pressed.

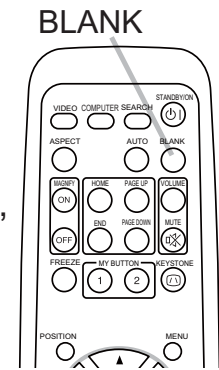

**NOTE** • The sound is not connected with the blank screen function. If necessary, set the volume or mute first.

## Operating

### Using the menu function

This projector has the following menus:

PICTURE, IMAGE, INPUT, SETUP, SCREEN, OPTION and EASY MENU.

EASY MENU consists of functions often used, and the other menus are classified into each purpose and brought together as Advanced Menu.

Each of these menus is operated using the same methods. The basic operations of these menus are as follows.

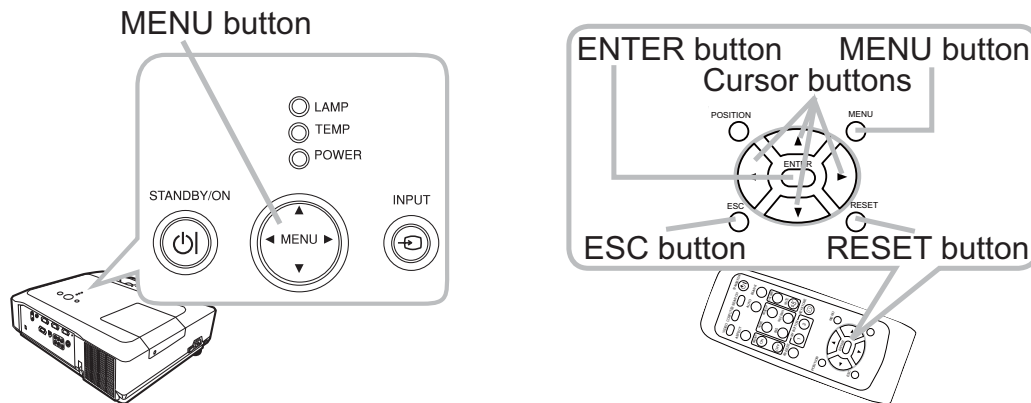

1. Press the MENU button on the remote control or the projector.
  - The Advanced Menu or EASY MENU, which has priority just after powered on will appear.

If you want to move the menu position, use the cursor buttons after pressing the POSITION button. While the projector is displaying any menu, MENU button on the projector works as the cursor buttons.

#### In the EASY MENU

2. If you want to change it to the Advanced Menu, select the “Go to Advanced Menu...”
3. Use the ▲/▼ cursor buttons to select an item to operate.
4. Use the ◀/▶ cursor buttons to operate the item.



EASY MENU

(continued on next page)

**Using the menu function (continued)****In the Advanced Menu**

2. Use the ▲/▼ cursor buttons to select a menu.
  - If you want to change it to the EASY MENU, select EASY MENU.
  - Then press the ► cursor button, or ENTER button to select an item. The lower layer menu of the selected item will appear.



Advanced Menu

3. Use the ▲/▼ cursor buttons to select an item to operate.
  - Then press the ► cursor button, or ENTER button to progress. The operation menu of the selected item will appear.
4. Use the ▲/▼ cursor buttons to operate the item.
  - Some functions cannot be performed when a certain input port is selected, or when a certain input signal is displayed.
  - When you want to reset the operation, press RESET button on the remote control during the operation. Note that some items (ex. LANGUAGE, H PHASE, VOLUME) cannot be reset.
  - In the Advanced Menu, when you want to return to the previous display, press the ◀ cursor button or ESC button on the remote control.
5. Press MENU button on the remote control again to close the menu and complete this operation. Even if you do not do anything, the dialog will automatically disappear after about 10 seconds.





## EASY MENU

## EASY MENU

From the EASY MENU, items shown in the table below can be performed.

Select an item using the ▲/▼ cursor buttons. Then perform it according to the following table.



Item	Description																								
<b>ASPECT</b>	Using the ◀/▶ buttons switches the mode for aspect ratio. See the ASPECT item in IMAGE menu (📖29).																								
<b>AUTO KEYSTONE EXECUTE</b> 	Using the ▶ button executes the auto keystone function. See AUTO KEYSTONE  EXECUTE item in SETUP menu (📖34).																								
<b>KEYSTONE</b> 	Using the ◀/▶ buttons corrects the vertical keystone distortion. See KEYSTONE  item in SETUP menu (📖34).																								
<b>PICTURE MODE</b>	<p>Using the ◀/▶ buttons switches the picture mode. The picture modes are combinations of GAMMA and COLOR TEMP settings. Choose a suitable mode according to the projected source.</p> <p>  </p> <table border="1"> <thead> <tr> <th></th> <th>COLOR TEMP</th> <th>GAMMA</th> </tr> </thead> <tbody> <tr> <td>NORMAL</td> <td>#2 MID DEFAULT</td> <td>#1 DEFAULT</td> </tr> <tr> <td>CINEMA</td> <td>#3 LOW DEFAULT</td> <td>#2 DEFAULT</td> </tr> <tr> <td>DYNAMIC</td> <td>#1 HIGH DEFAULT</td> <td>#3 DEFAULT</td> </tr> <tr> <td>BOARD(BLACK)</td> <td>#4 Hi-BRIGHT-1 DEFAULT</td> <td>#4 DEFAULT</td> </tr> <tr> <td>BOARD(GREEN)</td> <td>#5 Hi-BRIGHT-2 DEFAULT</td> <td>#4 DEFAULT</td> </tr> <tr> <td>WHITEBOARD</td> <td>#2 MID DEFAULT</td> <td>#5 DEFAULT</td> </tr> <tr> <td>DAYTIME</td> <td>#6 Hi-BRIGHT-3 DEFAULT</td> <td>#6 DEFAULT</td> </tr> </tbody> </table> <ul style="list-style-type: none"> <li>• When the combination of GAMMA and COLOR TEMP differs from pre-assigned modes above, the display on the menu for the PICTURE MODE is “CUSTOM”. Please refer to GAMMA (📖26) and COLOR TEMP (📖26) items in PICTURE menu.</li> <li>• When this function is performed, a certain extra such as a line may appear.</li> </ul>		COLOR TEMP	GAMMA	NORMAL	#2 MID DEFAULT	#1 DEFAULT	CINEMA	#3 LOW DEFAULT	#2 DEFAULT	DYNAMIC	#1 HIGH DEFAULT	#3 DEFAULT	BOARD(BLACK)	#4 Hi-BRIGHT-1 DEFAULT	#4 DEFAULT	BOARD(GREEN)	#5 Hi-BRIGHT-2 DEFAULT	#4 DEFAULT	WHITEBOARD	#2 MID DEFAULT	#5 DEFAULT	DAYTIME	#6 Hi-BRIGHT-3 DEFAULT	#6 DEFAULT
	COLOR TEMP	GAMMA																							
NORMAL	#2 MID DEFAULT	#1 DEFAULT																							
CINEMA	#3 LOW DEFAULT	#2 DEFAULT																							
DYNAMIC	#1 HIGH DEFAULT	#3 DEFAULT																							
BOARD(BLACK)	#4 Hi-BRIGHT-1 DEFAULT	#4 DEFAULT																							
BOARD(GREEN)	#5 Hi-BRIGHT-2 DEFAULT	#4 DEFAULT																							
WHITEBOARD	#2 MID DEFAULT	#5 DEFAULT																							
DAYTIME	#6 Hi-BRIGHT-3 DEFAULT	#6 DEFAULT																							

(continued on next page)



**EASY MENU (continued)**

Item	Description
<b>BRIGHTNESS</b>	Using the ◀/▶ buttons adjusts the brightness. See BRIGHTNESS item in PICTURE menu (📖26).
<b>CONTRAST</b>	Using the ◀/▶ buttons adjusts the contrast. See CONTRAST item in PICTURE menu (📖26).
<b>COLOR</b>	Using the ◀/▶ buttons adjusts the strength of whole color. See COLOR item in PICTURE menu (📖26).
<b>TINT</b>	Using the ◀/▶ buttons adjusts the tint. See TINT item in PICTURE menu (📖26).
<b>SHARPNESS</b>	Using the ◀/▶ buttons adjusts the sharpness. See SHARPNESS item in PICTURE menu (📖27).
<b>WHISPER</b>	Using the ◀/▶ buttons turns off/on the whisper mode. See WHISPER item in SETUP menu (📖35).
<b>MIRROR</b>	Using the ◀/▶ buttons switches the mode for mirror status. See MIRROR item in SETUP menu (📖35).
<b>RESET</b>	Performing this item resets all of EASY MENU items except FILTER TIME and LANGUAGE. A dialog is displayed for confirmation. Selecting RESET using the ▲ button performs resetting.
<b>FILTER TIME</b>	Performing this item resets the filter time which counts usage time of the air filter. A dialog is displayed for confirmation. Selecting RESET using the ▲ button performs resetting. See FILTER TIME item in OPTION menu (📖41).
<b>LANGUAGE</b>	Using the ◀/▶ buttons changes the display language. See LANGUAGE item in SCREEN menu (📖36).
<b>Go to Advanced Menu...</b>	Select “Go to Advanced Menu...” on the menu, and press the ▶ or ENTER button to use the menu of PICTURE, IMAGE, INPUT, SETUP, SCREEN or OPTION.

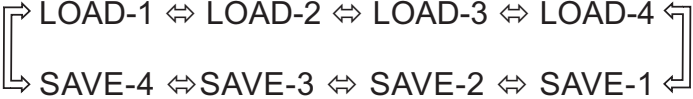

**PICTURE Menu (continued)**

Item	Description
<b>SHARPNESS</b>	<p>Using the ▲/▼ buttons adjusts the sharpness.</p> <p>Strong ⇔ Weak</p> <ul style="list-style-type: none"> <li>• There may be some noise and/or the screen may flicker for a moment when an adjustment is made. This is not a malfunction.</li> </ul>
<b>MY MEMORY</b>	<p>This projector has 4 memories for adjustment data (for all the items of PICTURE menu).</p> <p>Selecting a function using the ▲/▼ buttons and pressing the ► or ENTER button performs each function.</p> <div style="text-align: center;">  <p>LOAD-1 ⇔ LOAD-2 ⇔ LOAD-3 ⇔ LOAD-4</p> <p>SAVE-4 ⇔ SAVE-3 ⇔ SAVE-2 ⇔ SAVE-1</p> </div> <p><b><u>LOAD-1, LOAD-2, LOAD-3, LOAD-4</u></b></p> <p>Performing a LOAD function loads the data from the memory linked in the number included in the function's name, and adjusts the picture automatically depending on the data.</p> <ul style="list-style-type: none"> <li>• The LOAD functions whose linked memory has no data are skipped.</li> <li>• Remember that the current adjusted condition will be lost by loading data. If you want to keep the current adjustment, please save it before performing a LOAD function.</li> <li>• There may be some noise and the screen may flicker for a moment when loading data. This is not malfunction.</li> <li>• You can perform the LOAD function using MY BUTTONs. Please see MY BUTTON item in OPTION menu (📖42).</li> </ul> <p><b><u>SAVE-1, SAVE-2, SAVE-3, SAVE-4</u></b></p> <p>Performing a SAVE function saves the current adjustment data into the memory linked in the number included in the function's name.</p> <ul style="list-style-type: none"> <li>• Remember that the current data being stored of a memory will be lost by saving a new data into the memory.</li> </ul>

## PICTURE Menu

### PICTURE Menu (continued)

#### To adjust CUSTOM function in GAMMA and COLOR TEMP

Selecting a mode whose name includes CUSTOM in GAMMA or COLOR TEMP item and then pressing the ► button or ENTER button displays a dialog to aid you in adjusting the mode.

Choose an item using the ◀/▶ buttons, and adjust the level using the ▲/▼ buttons.

- When this function is performed, lines or other distortion may appear.

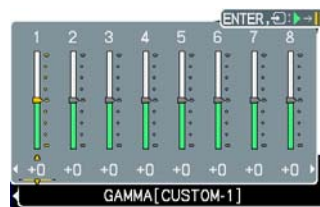

GAMMA

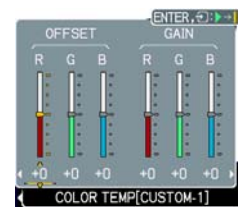

COLOR TEMP

You can display a test pattern on the top of the screen for checking the effect of your adjustment by pressing the ENTER button. Each time you press the ENTER button, the pattern changes as below.

No pattern ⇔ Gray scale of 9 steps



Ramp ⇔ Gray scale of 15 steps

- You can also adjust each function without displaying test patterns.

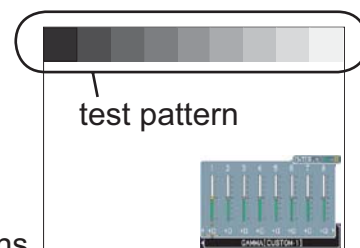

#### for adjusting GAMMA

You can change the brightness of particular tones.

The eight equalizing bars correspond to eight tone levels of the test pattern (Gray scale of 9 steps) except the darkest in the left end. If you want to adjust the 2nd tone from left end on the test pattern, use the equalizing adjustment bar "1". The darkest tone at the left end of the test pattern cannot be controlled with any of equalizing adjustment bar.

#### for adjusting COLOR TEMP

You can change the intensity of each of 3 colors (Red, Green, Blue).



OFFSET adjustments change the color intensity on the whole tones of the test pattern. GAIN adjustments mainly affect color intensity on the brighter tones of the test pattern.

## IMAGE Menu

From the IMAGE menu, items shown in the table below can be performed.

Select an item using the ▲/▼ cursor buttons, and press the ► cursor button or ENTER button to execute the item. Then perform it according to the following table.

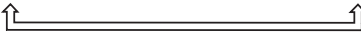
MENU (COMPUTER 1)		SELECT
PICTURE	ASPECT	4:3
IMAGE	OVER SCAN	5
INPUT	V POSITION	25
SETUP	H POSITION	142
SCREEN	H PHASE	16
OPTION	H SIZE	1344
EASY MENU	AUTO ADJUST EXECUTE	

Item	Description
<b>ASPECT</b>	<p>Using the ▲/▼ buttons switches the mode for aspect ratio.</p> <p><b>For a computer signal</b>            NORMAL ⇔ 4:3 ⇔ 16:9 ⇔ SMALL  </p> <p><b>For a video signal, s-video signal or component video signal</b>            4:3 ⇔ 16:9 ⇔ 14:9 ⇔ SMALL  </p> <p><b>For no signal</b>            4:3 (fixed)</p> <ul style="list-style-type: none"> <li>• This item can be selected only for a proper signal.</li> <li>• NORMAL mode keeps the original aspect ratio setting.</li> </ul>
<b>OVER SCAN</b>	<p>Using the ▲/▼ buttons adjusts the over-scan ratio.            Large (It reduces picture) ⇔ Small (It magnifies picture)</p> <ul style="list-style-type: none"> <li>• This item can be selected only for a video, s-video and component video signal.</li> <li>• When this adjustment is too large, certain degradation may appear at the frame area of the picture. In such a case, please adjust small.</li> </ul>
<b>V POSITION</b>	<p>Using the ▲/▼ buttons adjusts the vertical position.            Up ⇔ Down</p> <ul style="list-style-type: none"> <li>• Over-adjusting the vertical position may cause noise to appear on the screen. If this occurs please reset the vertical position to the default setting. Pressing RESET button when V POSITION is selected will reset V POSITION to the default setting.</li> <li>• When this function is performed on a video signal, s-video signal, or component video signal, the range of this adjustment depends on OVER SCAN (above) setting. It is not possible to adjust when OVER SCAN is set to 10.</li> </ul>
<b>H POSITION</b>	<p>Using the ▲/▼ buttons adjusts the horizontal position.            Left ⇔ Right</p> <ul style="list-style-type: none"> <li>• Over-adjusting the horizontal position may cause noise to appear on the screen. If this occurs please reset the horizontal position to the default setting. Pressing RESET button when H POSITION is selected will reset H POSITION to the default setting.</li> <li>• When this function is performed on a video signal, s-video signal, or component video signal, the range of this adjustment depends on OVER SCAN (above) setting. It is not possible to adjust when OVER SCAN is set to 10.</li> </ul>

(continued on next page)

## IMAGE Menu

**IMAGE Menu (continued)**

Item	Description
<b>H PHASE</b>	<p>Using the ▲/▼ buttons adjusts the horizontal phase to eliminate flicker. Right ⇔ Left</p> <ul style="list-style-type: none"> <li>• This item can be selected only for a computer signal or component video signal.</li> </ul>
<b>H SIZE</b>	<p>Using the ▲/▼ buttons adjusts the horizontal size. Large ⇔ Small</p> <ul style="list-style-type: none"> <li>• This item can be selected only for a computer signal.</li> <li>• When this adjustment is excessive, the picture may not be displayed correctly. In such a case, please reset the adjustment by pressing the RESET button during this operation.</li> </ul>
<b>AUTO ADJUST EXECUTE</b>	<p>Executing this item performs the automatic adjustment feature.</p> <p><b>For a computer signal</b> The vertical position, the horizontal position and the horizontal phase (📖43) will be automatically adjusted. And the horizontal size will be automatically set to the default. Make sure that the application window is set to its maximum size prior to attempting to use this feature. A dark picture may still be incorrectly adjusted. Use a bright picture when adjusting.</p> <p><b>For a video signal, s-video signal or component video signal</b> The video format best suited for the respective input signal will be selected automatically. This function is available only when the AUTO mode is selected to VIDEO FORMAT item in INPUT menu (📖32). The vertical position and horizontal position will be automatically set to the the default.</p> <p>For a component video signal, also the horizontal phase will be automatically set to the default.</p> <ul style="list-style-type: none"> <li>• The automatic adjustment operation requires several seconds. Also please note that it may not function correctly with some input. When this function is performed for a video signal, a certain extra such as a line may appear outside a picture.</li> <li>• The items adjusted by this function may vary when FINE or DISABLE is selected for AUTO ADJUST item of SERVICE item in OPTION menu (📖43).</li> </ul>

## INPUT Menu

From the INPUT menu, items shown in the table below can be performed.

Select an item using the ▲/▼ cursor buttons, and press the ► cursor button or ENTER button to execute the item. Then perform it according to the following table.



Item	Description
<b>PROGRESSIVE</b>	<p>Using the ▲/▼ buttons switches the progress mode. TV ⇔ FILM ⇔ TURN OFF</p> <ul style="list-style-type: none"> <li>• This function is performed only for an interlaced signal of a video, s-video or component video of 525i (480i) or 625i (576i) signal.</li> <li>• When TV or FILM is selected, the screen image will be sharp. FILM adapts to the 2-3 Pull-Down conversion system. But these may cause a certain defect (for example, jagged line) of the picture for a quick moving object. In such a case, please select TURN OFF, even though the screen image may lose the sharpness.</li> </ul>
<b>VIDEO NR</b>	<p>Using the ▲/▼ buttons switches the noise reduction mode. HIGH ⇔ MID ⇔ LOW</p> <ul style="list-style-type: none"> <li>• This function performs only for a video, s-video or component video of 525i(480i) or 625i(576i) signal.</li> <li>• When this function is excessive, it may cause a certain degradation of the picture.</li> </ul>
<b>COLOR SPACE</b>	<p>Using the ▲/▼ buttons switches the mode for color space. AUTO ⇔ RGB ⇔ SMPTE240 ⇔ REC709 ⇔ REC601</p> <p style="text-align: center;">↑—————↑</p> <ul style="list-style-type: none"> <li>• This item can be selected only for a computer signal or component video signal except SCART RGB signal.</li> <li>• The AUTO mode automatically selects the optimum mode.</li> <li>• The AUTO operation may not work well at some signals. In such a case, it might be good to select a suitable mode except AUTO.</li> </ul>
<b>COMPONENT</b>	<p>Using the ▲/▼ buttons switches the function of the COMPONENT (Y, Cb/Pb, Cr/Pr) port. COMPONENT ⇔ SCART RGB</p> <p>When the SCART RGB is selected, COMPONENT (Y, Cb/Pb, Cr/Pr) and VIDEO ports will function as a SCART RGB port. A SCART cable is required for a SCART RGB input to the projector. For your reference, see the TECHNICAL part.</p>

(continued on next page)

## INPUT Menu



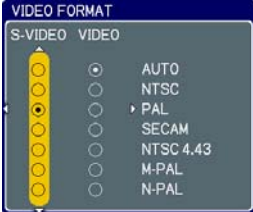
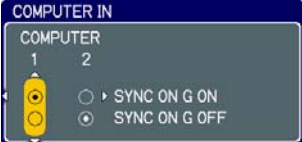

## INPUT Menu (continued)

Item	Description
<b>VIDEO FORMAT</b>	<p>The video format for S-VIDEO port and VIDEO port can be set.</p> <p>(1) Use the ◀/▶ buttons to select the input port.</p> <p>(2) Using the ▲/▼ buttons switches the mode for video format.</p> <p>AUTO ⇔ NTSC ⇔ PAL ⇔ SECAM          ↕ N-PAL ⇔ M-PAL ⇔ NTSC4.43 ↕</p> <ul style="list-style-type: none"> <li>• This item is performed only for a video signal from VIDEO port or S-VIDEO port.</li> <li>• The AUTO mode automatically selects the optimum mode.</li> <li>• The AUTO operation may not work well for some signals. If the picture becomes unstable (e.g. an irregular picture, lack of color), please select the mode according to the input signal.</li> </ul> 
<b>FRAME LOCK</b>	<p>Using the ▲/▼ buttons turns the frame lock function on/off.</p> <p>TURN ON ⇔ TURN OFF</p> <ul style="list-style-type: none"> <li>• This item can be performed only on a computer signal with a vertical frequency of 50 to 60 Hz.</li> <li>• When the TURN ON is selected, a moving pictures are displayed more smoothly.</li> <li>• This function may cause a certain degradation of the picture. In such a case, please select TURN OFF.</li> </ul>
<b>COMPUTER IN</b>	<p>The computer input signal type for COMPUTER IN1 and IN2 ports can be set.</p> <p>(1) Use the ◀/▶ buttons to select the input port to be set.</p> <p>COMPUTER (IN)1 ⇔ COMPUTER (IN)2</p> <p>(2) Use the ▲/▼ buttons to select the computer input signal type.</p> <p>SYNC ON G ON ⇔ SYNC ON G OFF</p> <p>Selecting SYNC ON G ON allows reception of sync on Green signal.</p> <ul style="list-style-type: none"> <li>• When SYNC ON G ON is selected, the picture may be distorted with certain input signals. In such a case, remove the signal connector first and select SYNC ON G OFF on the menu, and then reconnect the signal.</li> </ul> 

(continued on next page)

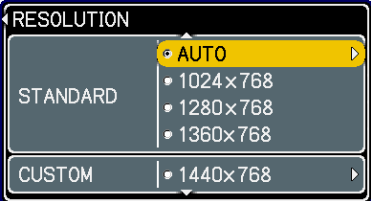

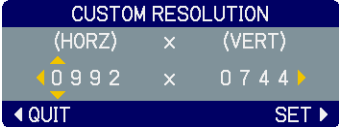
**INPUT Menu (continued)**

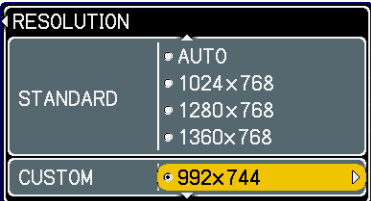
Item	Description
<b>RESOLUTION</b>	<p>The resolution for the COMPUTER IN1 and IN2 input signals can be set on this projector.</p> <p>(1) In INPUT menu select RESOLUTION using the ▲/▼ buttons and press the ► button. The RESOLUTION menu will be displayed.</p> <p>(2) In the RESOLUTION menu, select the resolution you wish to display using the ▲/▼ buttons. Selecting AUTO will set a resolution appropriate to the input signal.</p>  <p>(3) STANDARD Pressing the ► or ENTER button when selecting a STANDARD resolution will automatically adjust the horizontal and vertical positions, clock phase and horizontal size and automatically select an aspect ratio.</p>  <p>(3) CUSTOM (3)-1 To set a custom resolution use the ▲/▼ buttons to select the CUSTOM and the CUSTOM RESOLUTION box will be displayed. Set the horizontal (HORZ) and vertical (VERT) resolutions using the ▲/▼/◀/▶ buttons. Although not all resolutions are guaranteed.</p>  <p>(3)-2 To save the setting place the cursor on the right-most digit and press the ► button. The horizontal and vertical positions, clock phase and horizontal size will be automatically adjusted and an aspect ratio will be automatically selected.</p>  <p>(3)-3 To revert back to the previous resolution without saving changes place the cursor on the left-most digit and press the ◀ button. The screen will then return to the RESOLUTION menu displaying the previous resolution.</p>  <p>• For some pictures, this function may not work well.</p>



## SETUP Menu

### SETUP Menu

From the SETUP menu, items shown in the table below can be performed.

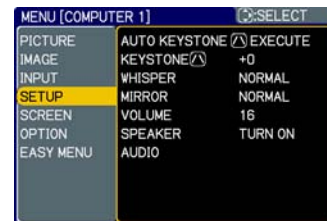



Select an item using the ▲/▼ cursor buttons, and press the ► cursor button or the ENTER button to execute the item. Then perform it according to the following table.



Item	Description
<b>AUTO KEYSTONE</b>  <b>EXECUTE</b>	<p>Selecting this item performs the automatic keystone distortion correction. Projector automatically corrects vertical keystone distortion due to the (forward/backward) setup angle by itself.</p> <p>This function will be executed only once when selected in the menu. When the slant of the projector is changed, execute this function again.</p> <ul style="list-style-type: none"> <li>• The adjustable range for correction will vary among inputs. For some input, this function may not work well.</li> <li>• When V:INVERT or H&amp;V:INVERT is selected to the MIRROR item in the SETUP menu, if the projector screen is inclined or angled downward, this function may not work correctly.</li> <li>• When the zoom adjustment is set to the TELE (telephoto focus), this function may be excessive. This function should be used when the zoom adjustment is set to the full WIDE (wide-angle focus) whenever possible.</li> <li>• When the projector is placed on the level (about <math>\pm 0^\circ</math>), this function may not work.</li> <li>• When the projector is inclined to near <math>\pm 30</math> degree or over, this function may not work well.</li> <li>• This function will be unavailable when the Transition Detector is on (<a href="#">49</a>).</li> </ul>
<b>KEYSTONE</b> 	<p>Using the ▲/▼ buttons corrects the vertical keystone distortion.</p> <p>Shrink the top of the image ⇔ Shrink the bottom of the image</p> <ul style="list-style-type: none"> <li>• The adjustable range of this function will vary with the type of input signal. For some input, this function may not work well.</li> <li>• This function will be unavailable when the Transition Detector is on (<a href="#">49</a>).</li> </ul>

(continued on next page)

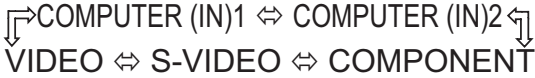
**SETUP Menu (continued)**

Item	Description																																								
<b>WHISPER</b>	Using the ▲/▼ buttons turns off/on the whisper mode. NORMAL ⇔ WHISPER • When WHISPER is selected, acoustic noise and screen brightness are reduced.																																								
<b>MIRROR</b>	Using the ▲/▼ buttons switches the mode for mirror status.  NORMAL ⇔ H:INVERT ⇔ V:INVERT ⇔ H&V:INVERT  If the Transition Detector is TURN ON and MIRROR status is changed, Transition Detector Alarm (🔊49) will be displayed when projector is restarted after the power switch is turned off.																																								
<b>VOLUME</b>	Using the ▲/▼ buttons adjusts the volume. High ⇔ Low																																								
<b>SPEAKER</b>	Using the ▲/▼ buttons turns on/off the built-in speaker. TURN ON ⇔ TURN OFF When TURN OFF is selected, the built-in speaker does not work.																																								
<b>AUDIO</b>	Allocates the audio ports. (1) Choose a picture input port using the ▲/▼ buttons.  (2) Select the audio port to be interlocked with the input port using the ◀/▶ buttons. 1 ⇔ 2 ⇔ 3 ⇔ <del>X</del>  When <del>X</del> is selected to an input port, any audio ports do not work interlocking with the input port, and any items in AUDIO menu are invalid. <div data-bbox="1101 1087 1422 1325" style="float: right; border: 1px solid black; padding: 5px; margin-top: 10px;"> <table border="1"> <thead> <tr> <th colspan="5">AUDIO</th> </tr> <tr> <th colspan="5">◀ QUIT</th> </tr> <tr> <th></th> <th>1</th> <th>2</th> <th>3</th> <th>🔊</th> </tr> </thead> <tbody> <tr> <td>COMPUTER 1</td> <td>●</td> <td>○</td> <td>○</td> <td>○</td> </tr> <tr> <td>COMPUTER 2</td> <td>○</td> <td>●</td> <td>○</td> <td>○</td> </tr> <tr> <td>COMPONENT</td> <td>○</td> <td>○</td> <td>●</td> <td>○</td> </tr> <tr> <td>S-VIDEO</td> <td>○</td> <td>○</td> <td>●</td> <td>○</td> </tr> <tr> <td>VIDEO</td> <td>○</td> <td>○</td> <td>●</td> <td>○</td> </tr> </tbody> </table> </div>	AUDIO					◀ QUIT						1	2	3	🔊	COMPUTER 1	●	○	○	○	COMPUTER 2	○	●	○	○	COMPONENT	○	○	●	○	S-VIDEO	○	○	●	○	VIDEO	○	○	●	○
AUDIO																																									
◀ QUIT																																									
	1	2	3	🔊																																					
COMPUTER 1	●	○	○	○																																					
COMPUTER 2	○	●	○	○																																					
COMPONENT	○	○	●	○																																					
S-VIDEO	○	○	●	○																																					
VIDEO	○	○	●	○																																					



**SCREEN Menu (continued)**

Item	Description								
<b>START UP</b>	<p>Using the ▲/▼ buttons switches the mode for the start-up screen. The start-up screen is a screen displayed when no signal or an unsuitable signal is detected.</p> <p style="text-align: center;">MyScreen ⇔ ORIGINAL ⇔ TURN OFF  </p> <table border="1" data-bbox="493 508 1414 695"> <thead> <tr> <th></th> <th>Feature</th> </tr> </thead> <tbody> <tr> <td>MyScreen</td> <td>Screen can be registered by the MyScreen item (<a href="#">📖 38</a>).</td> </tr> <tr> <td>ORIGINAL</td> <td>Screen preset as the standard screen.</td> </tr> <tr> <td>TURN OFF</td> <td>Plain black screen.</td> </tr> </tbody> </table> <ul style="list-style-type: none"> <li>• To avoid remaining as an afterimage, the MyScreen or ORIGINAL screen will change to the BLANK screen (<a href="#">📖 36</a>) after several minutes. If also the BLANK screen is the MyScreen or ORIGINAL, the plain black screen is instead used.</li> <li>• When the TURN ON is selected to the MyScreen PASSWORD of SECURITY item in OPTION menu (<a href="#">📖 46</a>), the START UP is fixed to MyScreen.</li> </ul>		Feature	MyScreen	Screen can be registered by the MyScreen item ( <a href="#">📖 38</a> ).	ORIGINAL	Screen preset as the standard screen.	TURN OFF	Plain black screen.
	Feature								
MyScreen	Screen can be registered by the MyScreen item ( <a href="#">📖 38</a> ).								
ORIGINAL	Screen preset as the standard screen.								
TURN OFF	Plain black screen.								





(continued on next page)

**SCREEN Menu (continued)**

Item	Description
<p><b>MyScreen</b></p>	<p>This item allows you to capture an image for use as a MyScreen image which can be used as the BLANK screen and START UP screen. Display the image you want to capture before executing the following procedure.</p> <ol style="list-style-type: none"> <li>1. Selecting this item displays a dialog titled “MyScreen”. It will ask you if you start capturing an image from the current screen.           <div data-bbox="1065 470 1427 548" data-label="Image"> </div> <p>Please wait for the target image to be displayed, and press the ENTER button when the image is displayed. The image will freeze and the frame for capturing will appear. To stop performing, press the RESET or ESC button.</p> </li> <li>2. Using the ▲/▼/◀/▶ buttons adjusts the frame position.           <div data-bbox="1065 758 1427 1031" data-label="Image"> </div> <p>Please move the frame to the position of the image which you want to use. The frame may not be able to be moved for some input signals. To start registration, press the ENTER button. To restore the screen and return to the previous dialog, press the RESET or ESC button. Registration takes several minutes. When the registration is completed, the registered screen and the following message are displayed for several seconds: <b>“MyScreen registration is finished.”</b> If the registration failed, the following message is displayed: <b>“A capturing error has occurred. Please try again.”</b></p> <ul style="list-style-type: none"> <li>• This function cannot be selected when the TURN ON is selected to the MyScreen Lock item (<a href="#">below</a>).</li> <li>• This function cannot be selected when TURN ON is selected to the MyScreen PASSWORD of SECURITY item in OPTION menu (<a href="#">46</a>).</li> </ul> </li> </ol>
<p><b>MyScreen Lock</b></p>	<p>Using the ▲/▼ buttons turns on/off the MyScreen lock function. TURN ON ⇔ TURN OFF</p> <p>When the TURN ON is selected, the MyScreen item is locked. Use this function for protecting the current MyScreen.</p> <ul style="list-style-type: none"> <li>• This function cannot be selected when TURN ON is selected to the MyScreen PASSWORD of SECURITY item in OPTION menu (<a href="#">46</a>).</li> </ul>

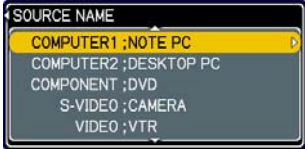
(continued on next page)

**SCREEN Menu (continued)**

Item	Description
<b>MESSAGE</b>	<p>Using the ▲/▼ buttons turns on/off the message function. TURN ON ⇔ TURN OFF</p> <p>When the TURN ON is selected, the following message function works. “AUTO IN PROGRESS” while automatically adjusting “NO INPUT IS DETECTED” “SYNC IS OUT OF RANGE” “Searching...” while searching for the input “Detecting...” while an input signal is detected The indication of the input signal displayed by changing The indication of the aspect ratio displayed by changing The indication of the PICTURE MODE displayed by changing The indication of the MY MEMORY displayed by changing The indication of “FREEZE” and “II” while freezing the screen by pressing FREEZE button.</p> <ul style="list-style-type: none"> <li>• When TURN OFF is selected, please remember if the picture is freezing. Do not mistake freezing for a malfunction (📖21).</li> </ul>
<b>SOURCE NAME</b>	<p>Each input port for this projector can have a name applied to it.</p> <p>(1) Use the ▲/▼ buttons on the SCREEN menu to select SOURCE NAME and press the ► button. The SOURCE NAME menu will be displayed.</p> <p>(2) Use the ▲/▼ buttons on the SOURCE NAME menu to select the port to be named and press the ► button. Right side of the menu is blank until a name is specified. The SOURCE NAME dialog will be displayed.</p> <p>(3) The current name will be displayed on the first line. Use the ▲/▼/◀/▶ buttons and the ENTER or INPUT button to select and enter characters. The RESET button can be used to erase 1 character at a time. The name can be a maximum of 16 characters.</p> <p>(4) To change an already inserted character, press the ▲ button while the cursor is on the [A-N] row to move the cursor to the name displayed on the first line and use the ◀/▶ buttons to select character to be changed. Once a character in the name is selected use the ▼ button to move the cursor back down to the character entry area to select and enter characters as described above.</p> <p>(5) Select  and press ENTER or INPUT buttons when finished entering text. To revert to the previous name without saving changes press the ESC or ◀ button and the INPUT button simultaneously.</p>    

## OPTION Menu

## OPTION Menu

From the OPTION menu, items shown in the table below can be performed.

Select an item using the ▲/▼ cursor buttons, and press the ► cursor button or ENTER button to execute the item, except for the items LAMP TIME and FILTER TIME. Then perform it according to the following table.

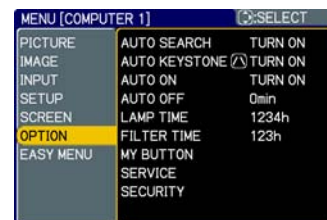



Item	Description
<b>AUTO SEARCH</b>	<p>Using the ▲/▼ buttons turns on/off the automatic signal search function. TURN ON ⇔ TURN OFF</p> <p>When the TURN ON is selected, detecting no signal automatically cycles through input ports in the following order. The search is started from the current port. Then when an input is found, the projector will stop searching and display the image.</p> <p> </p>
<b>AUTO KEYSTONE</b>	<p>Using the ▲/▼ buttons turns on/off the automatic keystone function. TURN ON ⇔ TURN OFF</p> <p>TURN ON : Automatic keystone distortion correction will be executed whenever changing the slant of the projector. TURN OFF : This function is disabled. Please execute the AUTO KEYSTONE  EXECUTE in the SETUP Menu for automatic keystone distortion correction.</p> <ul style="list-style-type: none"> <li>• When the projector is suspended from the ceiling this feature will not function properly so select the TURN OFF.</li> <li>• This function will be unavailable when the Transition Detector is on (<a href="#">49</a>).</li> </ul>
<b>AUTO ON</b>	<p>Using the ▲/▼ buttons turns on/off the AUTO ON function. TURN ON ⇔ TURN OFF</p> <p>When set to the TURN ON, the lamp in projector will be automatically turned on without the usual procedure (<a href="#">15</a>), only when the projector is supplied with the power after the power was cut while the lamp was on.</p> <ul style="list-style-type: none"> <li>• This function does not work as long as the power has been supplied to the projector while the lamp is off.</li> <li>• After turning the lamp on by the AUTO ON function, if neither input nor operation is detected for about 30 minutes, the projector is turned off, even though the AUTO OFF function (<a href="#">41</a>) is disabled.</li> </ul>

(continued on next page)





**OPTION Menu (continued)**

Item	Description
<b>AUTO OFF</b>	<p>Using the ▲/▼ buttons adjusts the time to count down to automatically turn the projector off.            Long (max. 99 minutes) ⇔ Short (min. 0 minute = DISABLE)</p> <div style="display: flex; justify-content: space-around; align-items: center;">   </div> <p>When the time is set to 0, the projector is not turned off automatically. When the time is set to 1 to 99, and when the passed time with no-signal or an unsuitable signal reaches at the set time, the projector lamp will be turned off.            If one of the projector's buttons or the remote control buttons is pressed or one of the commands (except get commands) is transmitted to the CONTROL port during the corresponding time, projector will not be turned off.            Please refer to the section "Turning off the power" (📖15).</p>
<b>LAMP TIME</b>	<p>The lamp time is the time counted after the last resetting. It is shown in OPTION menu as the usage time of the lamp.            Pressing RESET button or the ► button displays a dialog.            To reset the lamp time, select RESET using the ▲ button.            RESET ⇔ CANCEL</p> <ul style="list-style-type: none"> <li>• Please reset the lamp time only when you have replaced the lamp, for a suitable indication about the lamp.</li> <li>• For the lamp replacement, see the section "Lamp" (📖51).</li> </ul>
<b>FILTER TIME</b>	<p>The filter time is the time counted after the last resetting. It is shown in the OPTION menu as the usage time of the air filter.            Pressing the RESET button or the ► button displays a dialog.            To reset the filter time, select the RESET using the ▲ button.            RESET ⇔ CANCEL</p> <ul style="list-style-type: none"> <li>• Please reset the filter time only when you have cleaned or replaced the air filter, for a suitable indication about the air filter.</li> <li>• For the air filter cleaning, see the section "Air filter" (📖53).</li> </ul>

(continued on next page)

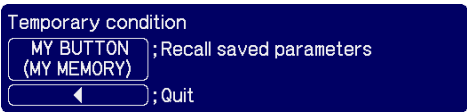

**OPTION Menu**

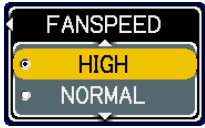
**OPTION Menu (continued)**

Item	Description
<p><b>MY BUTTON</b></p>	<p>This item is to assign one of the following functions to MY BUTTON 1 and 2 on the remote control (📖6). Choose 1 or 2 on the MY BUTTON menu using the ◀/▶ button first. Then using the ▲/▼ buttons sets one of the following functions to the chosen button.</p> <ul style="list-style-type: none"> <li>• COMPUTER1: Sets port to COMPUTER IN1.</li> <li>• COMPUTER2: Sets port to COMPUTER IN2.</li> <li>• COMPONENT: Sets port to COMPONENT(Y, Cb/Pb, Cr/Pr)</li> <li>• S-VIDEO: Sets port to S-VIDEO.</li> <li>• VIDEO: Sets port to VIDEO.</li> <li>• INFORMATION: Displays a dialog of INPUT INFORMATION (📖44).</li> <li>• AUTO KEYSTONE [ ] EXECUTE: Performs automatic keystone distortion correction (📖34).</li> <li>• MY MEMORY: Loads one of adjustment data stored (📖27).</li> </ul> <p>When the current adjustment is not saved to memory a dialog is displayed.</p> <p>When no data is saved in memory, a dialog is displayed.</p>   <p>If you want to keep the current adjustment, please press the ◀ button to quit. Otherwise the current adjusted condition will be lost by loading a data.</p> <ul style="list-style-type: none"> <li>• PICTURE MODE: Changes the PICTURE MODE (📖24).</li> <li>• FILTER RESET: Displays the filter time reset confirmation dialogue (📖41).</li> <li>• VOLUME+: Set the volume up.</li> <li>• VOLUME-: Set the volume down.</li> </ul>
<p><b>SERVICE</b></p>	<p>Selecting this item displays the SERVICE menu. Select an item using the ▲/▼ buttons, and press the ▶ button or the ENTER button to execute the item.</p> <p>FAN SPEED ⇄ AUTO ADJUST ⇄ GHOST ⇄ FILTER MESSAGE ⇄ KEY LOCK</p> <p>↑ ↓</p> <p>↙ ↘</p> <p>FACTORY RESET ⇄ I NFORMATION ⇄ REMOTE FREQ. ↙ ↘</p> <p><b>FAN SPEED</b></p> <p>Using the ▲/▼ buttons switches the rotation speed of the cooling fans. The HIGH is the mode for use at highlands etc. Note that the projector is noisier when the HIGH is selected.</p> <p>HIGH ⇄ NORMAL</p> 

(continued on next page)

**OPTION Menu (continued)**

Item	Description
<b>SERVICE</b> (continued)	<p><b>AUTO ADJUST</b></p> <p>Using the ▲/▼ buttons enables/disables the automatic adjustment. When DISABLE is selected, the automatic adjustment feature is disabled, although rough adjustment is automatically performed depending on the basic setting.</p> <p>FINE ⇔ FAST ⇔ DISABLE</p>  <p>FINE: Finer tuning including H.SIZE adjustment. FAST: Faster tuning, setting H.SIZE to prearranged data for the input signal.</p> <ul style="list-style-type: none"> <li>Depending on conditions, such as input image, signal cable to the projector, environment around the projector, etc., the automatic adjustment may not work correctly. In such a case, please choose DISABLE to disable the automatic adjustment, and make adjustment manually.</li> </ul>
	<p><b>GHOST</b></p> <ol style="list-style-type: none"> <li>Select a color element of ghost using the ◀/▶ buttons.</li> <li>Adjust the selected element using the ▲/▼ buttons to disappear ghost.</li> </ol>
	<p><b>FILTER MESSAGE</b></p> <p>Use the ▲/▼ button to set the timer for the interval to show the message for cleaning up the air filter.</p> <p>50h ⇔ 100h ⇔ 200h ⇔ 300h ⇔ 400h ⇔ 500h</p>  <p>TURN OFF ⇔ 800h ⇔ 700h ⇔ 600h</p> <p>After choosing a choice except “TURN OFF”, the message “REMINDER *** HRS PASSED AFTER THE LAST FILTER CHECK” will appear after the timer reaches the interval time set by this feature (📖55). When the “TURN OFF” is chosen, the message will not appear. Utilize this feature to keep the air filter clean, setting the suitable time according to your environment of this projector.</p> <ul style="list-style-type: none"> <li>Please check and clean the air filter periodically, even if there is no message. If the air filter becomes to be blocked by dust or others, the internal temperature will rise, which could cause malfunction, or reduce the lifetime of the projector.</li> <li>Please be careful with the operating environment of the projector and the condition of the air filter.</li> </ul>

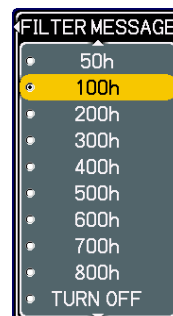
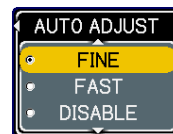





(continued on next page)

**OPTION Menu (continued)**

Item	Description
<b>SERVICE</b> (continued)	<p><b>KEY LOCK</b> Using the ▲/▼ buttons turns on/off the key lock feature. When TURN ON is selected, the buttons on the projector except the STANDBY/ON button are locked. TURN ON ⇔ TURN OFF</p> <ul style="list-style-type: none"> <li>• Please use to avoid a mischief and touching accidentally. This function does not have any effect on the remote control.</li> </ul> <p><b>REMOTE FREQ.</b> Use the ▲/▼ button to change the projector's remote sensor setting. 1:NORMAL ⇔ 2:HIGH</p> <p>Items with a checkmark are on. The factory default setting is for both 1:NORMAL and 2: HIGH to be on. If the remote control does not function correctly set this to either only 1 or only 2 (📖14). Neither can be turned off at the same time.</p>  <p><b>INPUT INFORMATION</b> Selecting this item displays a dialog titled "INPUT INFORMATION". It shows the information about the current input.</p> <div style="display: flex; justify-content: space-around; align-items: center;"> <div data-bbox="557 1068 761 1169" style="border: 1px solid black; padding: 5px; text-align: center;">       INPUT - INFORMATION - COMPUTER 1 1024x768 @60Hz FRAME LOCK     </div> <div data-bbox="855 1068 1060 1169" style="border: 1px solid black; padding: 5px; text-align: center;">       INPUT - INFORMATION - S-VIDEO PAL AUTO     </div> <div data-bbox="1154 1068 1359 1169" style="border: 1px solid black; padding: 5px; text-align: center;">       INPUT - INFORMATION - COMPONENT 1080i @60Hz     </div> </div> <ul style="list-style-type: none"> <li>• The "FRAME LOCK" message on the dialog means the frame lock function is working (📖32).</li> <li>• This item can't be selected for no signal and sync out.</li> </ul> <p><b>FACTORY RESET</b> Selecting RESET using the button ▲ performs this function. By this function, all the items in all of menus will collectively return to the initial setting. Note that the items LAMP TIME, FILTER TIME, LANGUAGE and SECURITY are not reset. RESET ⇔ CANCEL</p>

(continued on next page)

**OPTION Menu (continued)**

Item	Description
<b>SECURITY</b>	<p>This projector is equipped with security functions. User registration is required before using the security functions. Please contact your local dealer.</p> <p><b>1. Using Security Features</b></p> <p><b>1.1 Inputting the PASSWORD</b></p> <p>1.1-1 Use the ▲/▼ buttons on the OPTION menu to select SECURITY and press the ► button. The ENTER PASSWORD box will be displayed.</p>  <p>The factory default PASSWORD is <b>4473</b>. This PASSWORD can be changed (1.2 Changing the PASSWORD).</p> <ul style="list-style-type: none"> <li>It is strongly recommended the factory default PASSWORD to be changed as soon as possible.</li> </ul> <p>1.1-2 Use the ▲/▼/◀/► buttons to enter the registered PASSWORD. Move the cursor to the right side of the ENTER PASSWORD box and press the ► button to display the SECURITY menu.</p>  <p>If an incorrect PASSWORD is input the ENTER PASSWORD box will be displayed again. If incorrect PASSWORD is input 3 times the projector will turn off. Afterwards the projector will turn off every time an incorrect PASSWORD is input.</p> <p><b>1.2 Changing the PASSWORD</b></p> <p>1.2-1 Use the ▲/▼ buttons on the SECURITY menu to select SECURITY PASSWORD CHANGE and press the ► button to display the ENTER NEW PASSWORD box.</p>  <p>1.2-2 Use the ▲/▼/◀/► buttons to enter the new PASSWORD.</p> <p>1.2-3 Move the cursor to the right side of the ENTER NEW PASSWORD box and press the ► button to display the NEW PASSWORD AGAIN box, enter the same PASSWORD again.</p>  <p>1.2-4 Move the cursor to the right side of the NEW PASSWORD AGAIN box and press the ► button and the NOTE NEW PASSWORD box will be displayed for about 20 seconds, please make note of the PASSWORD during this time. Pressing the ENTER button will close the NOTE NEW PASSWORD box.</p>  <ul style="list-style-type: none"> <li>Please do not forget your PASSWORD.</li> </ul>



(continued on next page)

**OPTION Menu (continued)**

Item	Description
<b>SECURITY</b> (continued)	<p><b>1.3 If you have forgotten your PASSWORD</b></p> <p>1.3-1 Follow the procedure in 1.1-1 to display the ENTER PASSWORD box.</p> <p>1.3-2 While the ENTER PASSWORD box is displayed, press and hold the RESET button for about 3 seconds or press and hold the INPUT and ► buttons on the projector for about 3 seconds.</p> <div data-bbox="1081 459 1430 554" style="border: 1px solid black; padding: 2px;"> <p>SECURITY PASSWORD Inquiring Code 12 3456 7890</p> </div> <p>The 10-digit Inquiring Code will be displayed.</p> <ul style="list-style-type: none"> <li>• If there is no key input for about 55 seconds while the Inquiring Code is displayed the menu will close. If necessary repeat the process from 1.3-1.</li> </ul> <p>1.3-3 Contact your dealer with the 10-digit Inquiring Code. Your PASSWORD will be sent after your user registration information is confirmed.</p> <p><b>2. Using the MyScreen PASSWORD Function</b></p> <p>The MyScreen PASSWORD function can be used to prohibit access to the MyScreen function and prevent the currently registered MyScreen image from being overwritten.</p> <p><b>2.1 Turning on the MyScreen PASSWORD Function</b></p> <p>2.1-1 Use the ▲/▼ buttons on the SECURITY menu to select MyScreen PASSWORD and press the ► button to display the MyScreen PASSWORD on/off menu.</p> <div data-bbox="1101 1052 1430 1146" style="border: 1px solid black; padding: 2px;"> <p>MyScreen PASSWORD TURN ON TURN OFF</p> </div> <p><b>2.2 Setting the PASSWORD</b></p> <p>2.2-1 Display the MyScreen PASSWORD on/off menu using the procedure in 2.1-1.</p> <p>2.2-2 Use the ▲/▼ buttons on the MyScreen PASSWORD on/off menu to select TURN ON. The ENTER PASSWORD box (small) will be displayed.</p> <div data-bbox="1136 1346 1438 1461" style="border: 1px solid black; padding: 2px;"> <p>MyScreen ENTER PASSWORD 0 0 0 0 ◀ QUIT      NEXT ▶</p> </div> <p>2.2-3 Use the ▲/▼/◀/▶ buttons to enter the PASSWORD.</p> <p>Move the cursor to the right side of the ENTER PASSWORD box (small) and press the ► button to display the PASSWORD AGAIN box, enter the same PASSWORD again.</p> <div data-bbox="1136 1514 1438 1629" style="border: 1px solid black; padding: 2px;"> <p>MyScreen PASSWORD AGAIN 0 0 0 0 ◀ QUIT      NEXT ▶</p> </div>

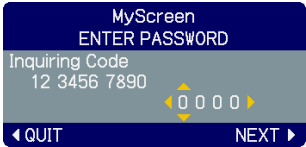

(continued on next page)

**OPTION Menu (continued)**

Item	Description
<b>SECURITY</b> (continued)	<p>2.2-4 Move the cursor to the right side of the PASSWORD AGAIN box and press the ► button to display the PASSWORD for about 20 seconds, please make note of the PASSWORD during this time.</p>  <p>Pressing the ENTER button will return to MyScreen PASS WORD on/off menu. When a PASSWORD is set for MyScreen:</p> <ul style="list-style-type: none"> <li>• The MyScreen registration function (and menu) will be unavailable.</li> <li>• The MyScreen Lock function (and menu) will be unavailable.</li> <li>• The START UP setting will be locked on MyScreen (and the menu will be unavailable).</li> </ul> <p>Turning the MyScreen PASSWORD off will allow normal operation of both functions.</p> <ul style="list-style-type: none"> <li>• Please do not forget your MyScreen PASSWORD.</li> </ul>
	<p><b>2.3 Turning the PASSWORD off</b></p> <p>2.3-1 Follow the procedure in 2.1-1 to display the MyScreen PASSWORD on/off menu.</p> <p>2.3-2 Select TURN OFF to display the ENTER PASSWORD box (large). Enter the registered PASSWORD and the screen will return to the MyScreen on/off menu. If an incorrect PASSWORD is input the menu will close. If necessary repeat the process from 2.3-1.</p>
	<p><b>2.4 If you have forgotten your PASSWORD</b></p> <p>2.4-1 Follow the procedure in 2.1-1 to display the MyScreen PASSWORD on/off menu.</p> <p>2.4-2 Select TURN OFF to display the ENTER PASSWORD box (large). The 10-digit Inquiring Code will be displayed inside the box.</p>  <p>2.4-3 Contact your dealer with the 10-digit Inquiring Code. Your PASSWORD will be sent after your user registration information is confirmed.</p>
	<p><b>3. Using the PIN LOCK Function</b></p> <p>PIN LOCK is a function which prevents the projector from being used unless a registered Code is input.</p> <p><b>3.1 Registering the PIN Code</b></p> <p>3.1-1 Use the ▲/▼ buttons on the SECURITY menu to select PIN LOCK and press the ► button or the ENTER button to display the PIN LOCK on/off menu.</p> 

(continued on next page)



**OPTION Menu (continued)**

Item	Description
<b>SECURITY</b> (continued)	<p>3.1-2 Use the ▲/▼ buttons on the PIN LOCK on/off menu to select TURN ON and the PIN BOX will be displayed.</p>  <p>3.1-3 Input a 4 part PIN Code using the ▲, ▼, ◀, ▶, COMPUTER and INPUT buttons. A PIN Code again box will appear. Reenter the same PIN Code. This will complete the PIN Code registration.</p>  <ul style="list-style-type: none"> <li>If there is no key input for about 55 seconds while the PIN BOX or the PIN Code again box are displayed the menu will close. If necessary repeat the process from 3.1-1.</li> </ul> <p>Afterwards, anytime the projector is restarted after AC power is turned off the PIN BOX will be displayed. Enter the registered PIN Code. The projector can be used after entering the registered PIN Code. If an incorrect PIN Code is input the PIN BOX will be displayed again. If an incorrect PIN Code is input 3 times the projector will turn off. Afterwards the projector will turn off every time an incorrect PIN Code is input. The projector will also turn off if there is no key input for about 5 minutes while the PIN BOX is displayed. This function will activate only when the projector is started after AC power is turned off.</p> <ul style="list-style-type: none"> <li>Please do not forget your PIN Code.</li> </ul> <p><b>3.2 Turning Off the PIN LOCK Function</b></p> <p>3.2-1 Follow the procedure in 3.1-1 to display the PIN LOCK on/off menu. Use the ▲/▼ buttons to select TURN OFF and the PIN BOX will be displayed. Enter the registered PIN Code to turn the PIN LOCK function off. If an incorrect PASSWORD is entered the menu will close.</p> <p><b>3.3 If you have forgotten your PIN Code</b></p> <p>3.3-1 While the PIN BOX is displayed, press and hold the RESET button for 3 seconds or press and hold the INPUT and ▶ buttons for 3 seconds. The 10-digit Inquiring Code will be displayed.</p>  <ul style="list-style-type: none"> <li>If it passes for about 5 minutes after the PIN BOX is displayed the projector will turn off.</li> </ul> <p>3.3-2 Contact your dealer with the 10-digit Inquiring Code. Your PASSWORD will be sent after your user registration information is confirmed.</p>

(continued on next page)

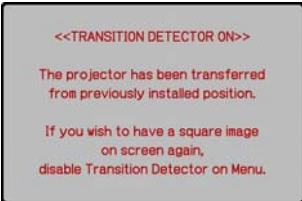

**OPTION Menu (continued)**

Item	Description
<b>SECURITY</b> (continued)	<p><b>4. Using the Transition Detector Function</b></p> <p>While the Transition Detector function is ON, when power switch is started to supply to the projector, it might react as below.</p> <ul style="list-style-type: none"> <li>• Transition Detector alarm shown below might appear on screen, if the projector has been moved or re-installed.</li> <li>• Transition Detector alarm might appear on screen, if the MIRROR setting has been changed.</li> <li>• Keystone adjustment feature has been prohibited as long as the Transition Detector function is ON.</li> </ul> <p><b>4.1 Turning On the Transition Detector Function</b></p> <p>4.1-1 Use the ▲/▼ buttons on the SECURITY menu to select TRANSITION DETECTOR and press the ► or the ENTER button to display the TRANSITION DETECTOR on/off menu. Select TURN ON and the current angle and mirror setting will be recorded.</p>  <ul style="list-style-type: none"> <li>• This feature may not function properly if the projector is not in a stable position when TURN ON is selected.</li> </ul> <p>4.1-2 If this function is set to TURN ON when the vertical angle of the projector or mirror setting at which the projector is turned on is different than the previously recorded the Transition Detector Alarm will be displayed and the projector will not display the input signal.</p>  <p>Set the Transition Detector off in the SECURITY menu to display the input signal.</p> <p>If the Transition Detector ALARM is displayed for about 5 minutes the lamp will turn off. This function will activate only when the projector is started after turning off the AC power.</p> <p><b>4.2 Setting the Transition Detector PASSWORD</b></p> <p>4.2-1 Use the ▲/▼ buttons on the SECURITY menu to select TRANSITION DETECTOR and press the ► or the ENTER button to display the TRANSITION DETECTOR on/off menu.</p> <p>4.2-2 Use the ▲/▼ buttons on the TRANSITION DETECTOR on/off menu to select TURN ON. The ENTER PASSWORD box (small) will be displayed.</p>  <p>4.2-3 Use the ▲/▼/◀/▶ buttons to enter a PASSWORD. Move the cursor to the right side of the ENTER PASSWORD box (small) and press the ► button to display the PASSWORD AGAIN box, enter the same PASSWORD again.</p> 

(continued on next page)

## OPTION Menu

## OPTION Menu (continued)

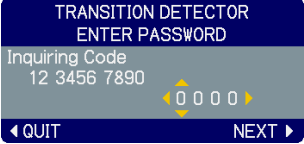
Item	Description
<b>SECURITY</b> (continued)	<p>4.2-4 Move the cursor to the right side of the PASSWORD AGAIN box and press the ► button to display the PASSWORD for about 20 seconds, please make note of the PASSWORD during this time.</p>  <p>Pressing the ENTER button will return to the TRANSITION DETECTOR on/off menu.</p> <ul style="list-style-type: none"> <li>• Please do not forget your Transition Detector PASSWORD.</li> </ul>
	<p><b>4.3 Setting the Transition Detector off</b></p>
	<p>4.3-1 Follow the procedure in 4.1-1 to display the TRANSITION DETECTOR on/off menu.</p>
	<p>4.3-2 Select TURN OFF to display the ENTER PASSWORD box (large). Enter the registered PASSWORD and the screen will return to the TRANSITION DETECTOR on/off menu. If an incorrect PASSWORD is input the menu will close. If necessary repeat the process from 4.3-1.</p>
	<p><b>4.4 If you have forgotten your PASSWORD</b></p>
<p>4.4-1 Follow the procedure in 4.1-1 to display the TRANSITION DETECTOR on/off menu.</p>	
<p>4.4-2 Select TURN OFF to display the ENTER PASSWORD box (large). The 10-digit Inquiring Code will be displayed inside the box.</p> 	
<p>4.4-3 Contact your dealer with the 10-digit Inquiring Code. Your PASSWORD will be sent after your user registration information is confirmed.</p>	

## Maintenance

### Lamp

A lamp has finite product life. Using the lamp for long periods of time could cause the pictures darker or the color tone poor. Note that each lamp has a different lifetime, and some may burst or burn out soon after you start using them. Preparation of a new lamp and early replacement are recommended. To prepare a new lamp, contact your dealer and tell the lamp type number.

**Type number : 78-6969-9917-2**

### Replacing the lamp

1. Turn the projector off, and unplug the power cord.
  1. Allow the projector to cool for at least 45 minutes.
2. Prepare a new lamp.
  1. If the projector is mounted on a ceiling, or if the lamp has broken, also ask the dealer to replace the lamp.

In case of replacement by yourself, follow the following procedure.

3. Loosen the screw (marked by arrow) of the lamp door and then slide the lamp door to the side to remove it.
4. Loosen the 2 screws (marked by arrow) of the lamp, and slowly pick up the lamp by the handles.
5. Insert the new lamp, and retighten firmly the 2 screws of the lamp that are loosened in the previous process to lock it in place.
6. Slide the lamp door back in place and firmly fasten the screw of the lamp door.
7. Turn the projector on and reset the lamp time using the LAMP TIME item in the OPTION menu.
  - (1) Press the MENU button to display a menu.
  - (2) Point at the "Go to Advanced Menu ..." in the menu using the ▼/▲ button, then press the ► button.
  - (3) Point at the "OPTION" in the left column of the menu using the ▼/▲ button, then press the ► button.
  - (4) Point at the "LAMP TIME" using the ▼/▲ button, then press the ► button. A dialog will appear.
  - (5) Press the ▲ button to select "RESET" on the dialog. It performs resetting the lamp time.

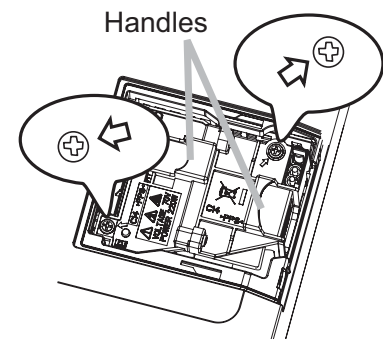
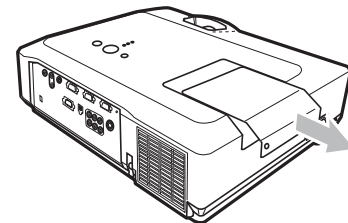
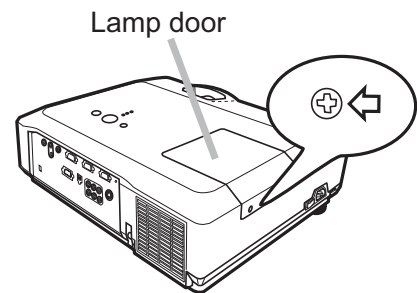

**⚠ CAUTION** ► Do not touch any inner space of the projector, while the lamp is taken out.

**NOTE** • Please reset the lamp time only when you have replaced the lamp, for a suitable indication about the lamp.

## Maintenance

**Lamp (continued)****Lamp warning**

 **HIGH VOLTAGE**     **HIGH TEMPERATURE**     **HIGH PRESSURE**

**⚠ WARNING** ► The projector uses a high-pressure mercury glass lamp. The lamp can break with a loud bang, or burn out, if jolted or scratched, handled while hot, or worn over time. Note that each lamp has a different lifetime, and some may burst or burn out soon after you start using them. In addition, when the bulb bursts, it is possible for shards of glass to fly into the lamp housing, and for gas containing mercury to escape from the projector's vent holes.

► **About disposal of a lamp:** This product contains a mercury lamp; do not put it in a trash. Dispose of it in accordance with environmental laws.

- For lamp recycling, go to [www.lamprecycle.org](http://www.lamprecycle.org). (in the US)
- For product disposal, contact your local government agency or [www.eiae.org](http://www.eiae.org) (in the US) or [www.epsc.ca](http://www.epsc.ca) (in Canada).

For more information, call your dealer.



Disconnect  
the plug  
from the  
power  
outlet

- If the lamp should break (it will make a loud bang when it does), unplug the power cord from the outlet, and make sure to request a replacement lamp from your local dealer. Note that shards of glass could damage the projector's internals, or cause injury during handling, so please do not try to clean the projector or replace the lamp yourself.
- If the lamp should break (it will make a loud bang when it does), ventilate the room well, and make sure not to breathe the gas that comes out of the projector vents, or get it in your eyes or mouth.
- Before replacing the lamp, turn the projector off and unplug the power cord, then wait at least 45 minutes for the lamp to cool sufficiently. Handling the lamp while hot can cause burns, as well as damaging the lamp.



- Never unscrew except the appointed (marked by an arrow) screws.
- Do not open the lamp door while the projector is suspended from above. This is dangerous, since if the lamp's bulb has broken, the shards will fall out when the cover is opened. In addition, working in high places is dangerous, so ask your local dealer to have the lamp replaced even if the bulb is not broken.
- Do not use the projector with the lamp door removed. At the lamp replacing, make sure that the screws are screwed in firmly. Loose screws could result in damage or injury.



- Use only the lamp of the specified type.
- If the lamp breaks soon after the first time it is used, it is possible that there are electrical problems elsewhere besides the lamp. If this happens, contact your local dealer or a service representative.
- Handle with care: jolting or scratching could cause the lamp bulb to burst during use.
- Using the lamp for long periods of time could cause it dark, not to light up or to burst. When the pictures appear dark, or when the color tone is poor, please replace the lamp as soon as possible. Do not use old (used) lamps; this is a cause of breakage.

## Air filter

Please check and clean the air filter periodically. When the indicators or a message prompts you to clean the air filter, comply with it as soon as possible. Replace the air filter when it is damaged or too soiled. To prepare a new air filter, contact your dealer and tell the air filter type number.

**Type number : 78-8118-9897-8**

When you replace the lamp, please replace the air filter. An air filter of specified type will come together with a replacement lamp for this projector.

### Cleaning the air filter

1. Turn the projector off, and unplug the power cord. Allow the projector to sufficiently cool down.
2. Use a vacuum cleaner on and around the filter cover.
3. Pull the filter cover knobs while lifting it. The filter unit which consists of the filter' cover, air filter and filter frame will come off.
4. Use a vacuum cleaner for the filter vent of the projector and the filter frame side of the filter unit. If the air filter is damaged or too soiled, replace it according to the following procedure number 5 to 7. Otherwise, please jump to the procedure number 8.
5. Pull the filter frame' knob up while holding the filter cover. The filter frame will come off and the air filter will appear.
6. Replace the air filter with new one.
7. Put the filter frame back.
8. Put the filter unit back into the projector.
9. Turn the projector on and reset the filter time using the FILTER TIME item in the EASY MENU.
  - (1) Press the MENU button to display a menu.
  - (2) Point at the "FILTER TIME" using the ▼/▲ button, then press the ► button. A dialog will appear.
  - (3) Press the ▲ button to select "RESET" on the dialog. It performs resetting the filter time.

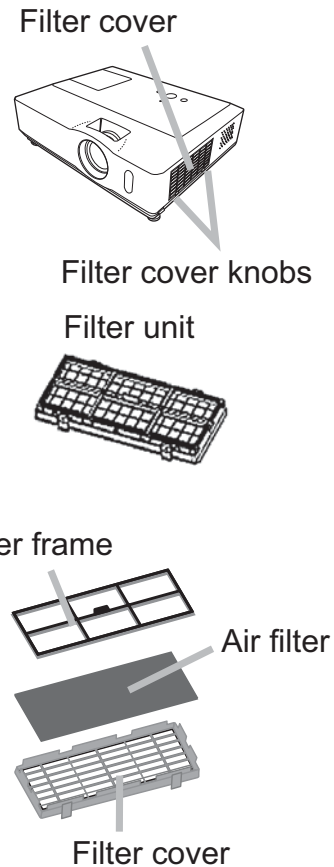

**⚠ WARNING** ► Before taking care of the air filter, make sure the power cable is not plugged in, then allow the projector to cool sufficiently.

► Use only the air filter of the specified type. Do not use the projector without the air filter or the filter cover. It could result in a fire or malfunction to the projector.

► Clean the air filter periodically. If the air filter becomes clogged by dust or the like, internal temperatures rise and could cause a fire, a burn or malfunction to the projector.

**NOTE** • Please reset the filter time only when you have cleaned or replaced the air filter, for a suitable indication about the air filter.

- The projector may display the message such as "CHECK THE AIR FLOW" or turn off the projector, to prevent the internal heat level rising.

## Other care

### Inside of the projector

In order to ensure the safe use of your projector, please have it cleaned and inspected by your dealer about once every year.

### Caring for the lens

If the lens is flawed, soiled or fogged, it could cause deterioration of display quality. Please take care of the lens, being cautious of handling.

1. Turn the projector off, and unplug the power cord. Allow the projector to cool sufficiently.
2. After making sure that the projector is cool adequately, lightly wipe the lens with a commercially available lens-cleaning wipe. Do not touch the lens directly with your hand.

### Caring for the cabinet and remote control

Incorrect care could have adverse influence such as discoloration, peeling paint, etc.

1. Turn the projector off, and unplug the power cord. Allow the projector to cool sufficiently.
2. After making sure that the projector is cool adequately, lightly wipe with gauze or a soft cloth.

If the projector is extremely dirty, dip soft cloth in water or a neutral cleaner diluted in water, and wipe lightly after wringing well. Then, wipe lightly with a soft, dry cloth.

**⚠ WARNING** ▶ Before caring, make sure the power cable is not plugged in, and then allow the projector to cool sufficiently. The care in a high temperature state of the projector could cause a burn and/or malfunction to the projector.

▶ Never try to care for the inside of the projector personally. Doing is so dangerous.

▶ Avoid wetting the projector or inserting liquids in the projector. It could result in a fire, an electric shock, and/or malfunction to the projector.

- Do not put anything containing water, cleaners or chemicals near the projector.

- Do not use aerosols or sprays.

**⚠ CAUTION** ▶ Please take right care of the projector according to the following. Incorrect care could cause not only an injury but adverse influence such as discoloration, peeling paint, etc.

▶ Do not use cleaners or chemicals other than those specified in this manual.

▶ Do not polish or wipe with hard objects.

## Troubleshooting

If an abnormal operation should occur, stop using the projector immediately.

**⚠ WARNING** ► Never use the projector if abnormal operations such as smoke, strange odor, excessive sound, damaged casing or elements or cables, penetration of liquids or foreign matter, etc. should occur. In such cases, immediately disconnect the power plug from the power outlet. After making sure that the smoke or odor has stopped, contact your dealer or service company.

Otherwise if a problem occurs with the projector, the following checks and measures are recommended before requesting repair.

If this does not resolve the problem, please contact your dealer or service company. They will tell you what warranty condition is applied.

### Related messages

When some message appears, check and cope with it according to the following table. Although these messages will be automatically disappeared around several minutes, it will be reappeared every time the power is turned on.

Message	Description
<div style="border: 1px solid black; padding: 5px; text-align: center;"> <b>NO INPUT IS DETECTED</b>            ***         </div>	<p><b>There is no input signal.</b> Please confirm the signal input connection, and the status of the signal source.</p>
<div style="border: 1px solid black; padding: 5px; text-align: center;"> <b>SYNC IS OUT OF RANGE</b>            ***  <b>[fH] **kHz [fV] **Hz</b> </div>	<p><b>The horizontal or vertical frequency of the input signal is not within the specified range.</b> Please confirm the specs for your projector or the signal source specs.</p>
<p style="text-align: center;"><b>CHECK THE AIR FLOW</b></p>	<p><b>The internal temperature is rising.</b> Please turn the power off, and allow the projector to cool down at least 20 minutes. After having confirmed the following items, please turn the power ON again.</p> <ul style="list-style-type: none"> <li>• Is there blockage of the air passage aperture?</li> <li>• Is the air filter dirty?</li> <li>• Does the peripheral temperature exceed 35°C?</li> </ul> <p>If the same indication is displayed after the remedy, please set FAN SPEED of the SERVICE item in the OPTION menu to HIGH.</p>
<p style="text-align: center;"><b>REMINDER</b>  <b>*** HRS PASSED AFTER THE</b>  <b>LAST FILTER CHECK.</b>  <b>FILTER MAINTENANCE IS ESSENTIAL</b>  <b>TO REMOVE WARNING MESSAGE,</b>  <b>RESET FILTER TIMER.</b>  <b>SEE MANUAL FURTHER INFO.</b></p>	<p><b>A note of precaution when cleaning the air filter.</b> Please immediately turn the power off, and clean or change the air filter referring to the “Air Filter” section of this manual. After you have cleaned or changed the air filter, please be sure to reset the filter timer ( 53).</p>

## Troubleshooting

### Regarding the indicator lamps

When operation of the LAMP, TEMP and POWER indicators differs from usual, check and cope with it according to the following table.

POWER indicator	LAMP indicator	TEMP indicator	Description
Lighting In <b>Orange</b>	Turned <b>off</b>	Turned <b>off</b>	<b>The projector is in a standby state.</b> Please refer to the section “Power on/off”.
<i>Blinking</i> In <b>Green</b>	Turned <b>off</b>	Turned <b>off</b>	<b>The projector is warming up.</b> Please wait.
Lighting In <b>Green</b>	Turned <b>off</b>	Turned <b>off</b>	<b>The projector is in an on state.</b> Ordinary operations may be performed.
<i>Blinking</i> In <b>Orange</b>	Turned <b>off</b>	Turned <b>off</b>	<b>The projector is cooling down.</b> Please wait.
<i>Blinking</i> In <b>Red</b>	(discre- tionary)	(discre- tionary)	<b>The projector is cooling down. A certain error has been detected.</b> Please wait until POWER indicator finishes blinking, and then perform the proper measure using the item descriptions below.
<i>Blinking</i> In <b>Red</b> or Lighting In <b>Red</b>	Lighting In <b>Red</b>	Turned <b>off</b>	<b>The lamp does not light, and there is a possibility that interior portion has become heated.</b> Please turn the power off, and allow the projector to cool down at least 20 minutes. After the projector has sufficiently cooled down, please make confirmation of the following items, and then turn the power on again. <ul style="list-style-type: none"> <li>• Is there blockage of the air passage aperture?</li> <li>• Is the air filter dirty?</li> <li>• Does the peripheral temperature exceed 35°C?</li> </ul> If the same indication is displayed after the remedy, please change the lamp referring to the section “Lamp”.
<i>Blinking</i> In <b>Red</b> or Lighting In <b>Red</b>	<i>Blinking</i> In <b>Red</b>	Turned <b>off</b>	<b>The lamp door has not been properly fixed.</b> Please turn the power off, and allow the projector to cool down at least 45 minutes. After the projector has sufficiently cooled down, please make confirmation of the attachment state of the lamp door. After performing any needed maintenance, turn the power on again. If the same indication is displayed after the remedy, please contact your dealer or service company.
<i>Blinking</i> In <b>Red</b> or Lighting In <b>Red</b>	Turned <b>off</b>	<i>Blinking</i> In <b>Red</b>	<b>The cooling fan is not operating.</b> Please turn the power off, and allow the projector to cool down at least 20 minutes. After the projector has sufficiently cooled down, please make confirmation that no foreign matter has become caught in the fan, etc., and then turn the power on again. If the same indication is displayed after the remedy, please contact your dealer or service company.

(continued on next page)



**Regarding the indicator lamps (continued)**

POWER indicator	LAMP indicator	TEMP indicator	Description
Blinking In <b>Red</b> or Lighting In <b>Red</b>	Turned off	Lighting In <b>Red</b>	<p><b>There is a possibility that the interior portion has become heated.</b></p> <p>Please turn the power off, and allow the projector to cool down at least 20 minutes. After the projector has sufficiently cooled down, please make confirmation of the following items, and then turn the power on again.</p> <ul style="list-style-type: none"> <li>• Is there blockage of the air passage aperture?</li> <li>• Is the air filter dirty?</li> <li>• Does the peripheral temperature exceed 35°C?</li> </ul> <p>If the same indication is displayed after the remedy, please set FAN SPEED of SERVICE item in OPTION menu to HIGH (📖42).</p>
Lighting In <b>Green</b>	Simultaneous blinking in <b>Red</b>		<p><b>It is time to clean the air filter.</b></p> <p>Please immediately turn the power off, and clean or change the air filter referring to the section "Air Filter". After cleaning or changing the air filter, please be sure to reset the filter timer. After the remedy, reset the power to ON.</p>
Lighting In <b>Green</b>	Alternative blinking in <b>Red</b>		<p><b>There is a possibility that the interior portion has become overcooled.</b></p> <p>Please use the unit within the usage temperature parameters (5°C to 35°C). After the treatment, reset the power to ON.</p>

**NOTE** • When the interior portion has become overheated, for safety purposes, the projector is automatically shut down, and the indicator lamps may also be turned off. In such a case, disconnect the power cord, and wait at least 45 minutes. After the projector has sufficiently cooled down, please make confirmation of the attachment state of the lamp and lamp door, and then turn the power on again.

**Shutting the projector down**

Only when the projector can not be turned off by usual procedure (📖15), please push the shutdown switch using a pin or similar, and disconnect the power plug from the power outlet. Before turning it on again, wait at least 10 minutes to make the projector cool down enough.

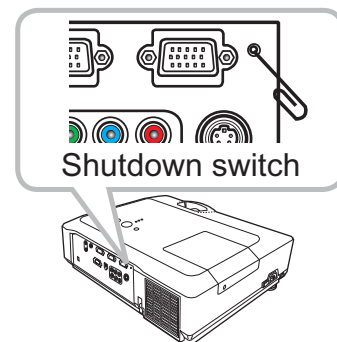
**Resetting all settings**

When it is hard to correct some wrong settings, the FACTORY RESET function of SERVICE item in OPTION menu (📖44) can reset all settings(except LANGUAGE, FILTER TIME, LAMP TIME, FILTER MESSAGE and etc.) to the factory default.

## Troubleshooting

### Phenomena that may be easy to be mistaken for machine defects

About the phenomenon confused with a machine defect, check and cope with it according to the following table.

Phenomenon	Cases not involving a machine defect	Reference page
Power does not come on.	<b>The electrical power cord is not plugged in.</b> Correctly connect the power cord.	12
	<b>The main power source has been interrupted during operation such as by a power outage (blackout), etc.</b> Please disconnect the power plug from the power outlet, and allow the projector to cool down at least 10 minutes, then turn the power on again.	12, 15
	<b>Either there is no lamp and/or lamp door, or either of these has not been properly fixed.</b> Please turn the power off and disconnect the power plug from the power outlet, and allow the projector to cool down at least 45 minutes. After the projector has sufficiently cooled down, please make confirmation of the attachment state of the lamp and lamp door, and then turn the power on again.	51, 52
Neither sounds nor pictures are outputted.	<b>The signal cables are not correctly connected.</b> Correctly connect the connection cables.	10
	<b>Signal source does not correctly work.</b> Correctly set up the signal source device by referring to the manual of the source device.	—
	<b>The input changeover settings are mismatched.</b> Select the input signal, and correct the settings.	16, 17
Sound does not come out.	<b>The signal cables are not correctly connected.</b> Correctly connect the audio cables.	10
	<b>The MUTE function is working.</b> Restore the sound pressing MUTE or VOLUME button on the remote control.	16
	<b>The volume is adjusted to an extremely low level.</b> Adjust the volume to a higher level using the menu function or the remote control.	16
	<b>The AUDIO/SPEAKER setting is not correct.</b> Correctly set the AUDIO/SPEAKER in SETUP menu.	35
No pictures are displayed.	<b>The lens cover is attached.</b> Remove the lens cover.	4, 15
	<b>The signal cables are not correctly connected.</b> Correctly connect the connection cables.	10

(continued on next page)

**Phenomena that may be easy to be mistaken for machine defects (continued)**

Phenomenon	Cases not involving a machine defect	Reference page
No pictures are displayed. (continued)	<b>The brightness is adjusted to an extremely low level.</b> Adjust BRIGHTNESS to a higher level using the menu function.	25, 26
	<b>The computer cannot detect the projector as a plug and play monitor.</b> Make sure that the computer can detect a plug and play monitor using another plug and play monitor.	11
	<b>The BLANK screen is displayed.</b> Press BLANK button on the remote control.	21
Video screen display freezes.	<b>The FREEZE function is working.</b> Press FREEZE button to restore the screen to normal.	21
Colors have a faded- out appearance, or Color tone is poor.	<b>Color settings are not correctly adjusted.</b> Perform picture adjustments by changing the COLOR TEMP, COLOR, TINT and/or COLOR SPACE settings, using the menu functions.	25, 26, 31
	<b>COLOR SPACE setting is not suitable.</b> Change the COLOR SPACE setting to AUTO, RGB, SMPTE240, REC709 or REC601.	31
Pictures appear dark.	<b>The brightness and/or contrast are adjusted to an extremely low level.</b> Adjust BRIGHTNESS and/or CONTRAST settings to a higher level using the menu function.	25, 26
	<b>The WHISPER function is working.</b> Select NORMAL for WHISPER item in the SETUP menu.	25, 35
	<b>The lamp is approaching the end of its product lifetime.</b> Replace the lamp.	51, 52
Pictures appear blurry.	<b>Either the focus and/or horizontal phase settings are not properly adjusted.</b> Adjust the focus using the focus ring, and/or H PHASE using the menu function.	18, 30
	<b>The lens is dirty or misty.</b> Clean the lens referring to the section "Caring for the lens".	55

**NOTE** • Although bright spots or dark spots may appear on the screen, this is a unique characteristic of liquid crystal displays, and it does not constitute or imply a machine defect.

## Specifications

## Specifications

## Specification

Item	Specification	
Product name	Liquid crystal projector	
Liquid Crystal Panel	Panel size	1.6 cm (0.63 type)
	Drive system	TFT active matrix
	Pixels	786,432 pixels (1024 horizontal x 768 vertical)
Lens	Zoom lens, F=1.7 ~ 1.9 f = 19.5~ 23.4 mm (approximately)	
Lamp	220W UHB	
Audio output	7 W	
Power supply	AC 100-120V/3.5A, AC220-240V/1.5A	
Power consumption	320W	
Temperature range	5 ~ 35°C (Operating)	
Size	340 (W) x 100 (H) x 270 (D) mm * Not including protruding parts. Please refer to the following figure.	
Weight (mass)	approx. 3.5 kg	
Ports	<p><b>Computer input port</b></p> <p>COMPUTER IN1 .....D-sub 15 pin mini x1</p> <p>COMPUTER IN2 .....D-sub 15 pin mini x1</p> <p><b>Computer output port</b></p> <p>MONITOR OUT .....D-sub 15 pin mini x1</p> <p><b>Video input port</b></p> <p>Y, Cb/Pb, Cr/Pr (Component video) ..... RCA x3</p> <p>S-VIDEO ..... mini DIN 4 pin x1</p> <p>VIDEO ..... RCA x1</p> <p><b>Audio input/output port</b></p> <p>AUDIO IN1 .....Stereo mini x1</p> <p>AUDIO IN2 .....Stereo mini x1</p> <p>AUDIO IN3 ..... RCA x2</p> <p>AUDIO OUT .....Stereo mini x1</p> <p><b>Others</b></p> <p>USB .....USB-B x1</p> <p>CONTROL ..... D-sub 9 pin x1</p>	

Specifications (continued)

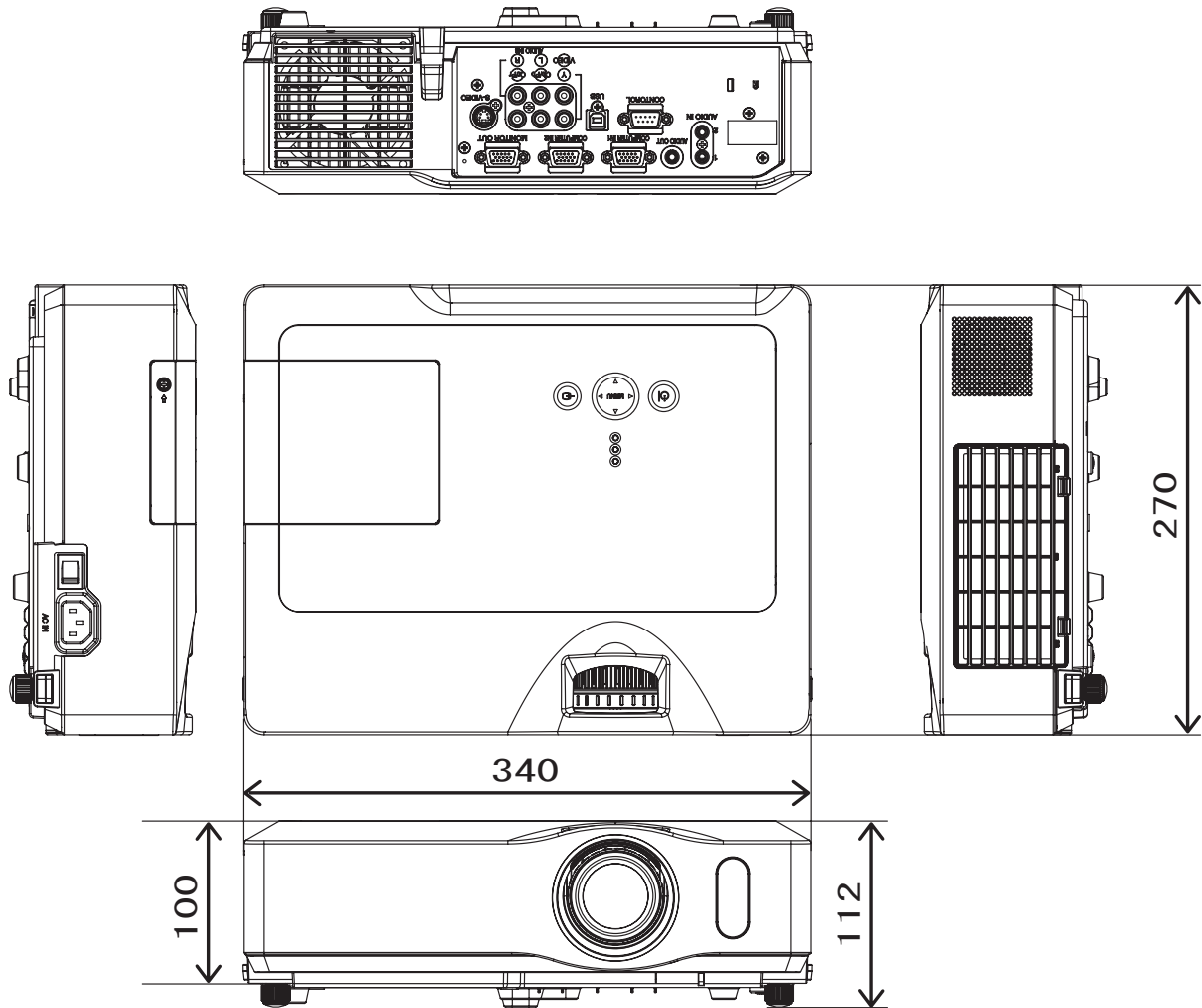

[unit: mm]

# 3M

# X64

## Operator's Guide **TECHNICAL**

### Example of PC signal

Resolution (H x V)	H. frequency (kHz)	V. frequency (Hz)	Rating	Signal mode
720 x 400	37.9	85.0	VESA	TEXT
640 x 480	31.5	59.9	VESA	VGA (60Hz)
640 x 480	37.9	72.8	VESA	VGA (72Hz)
640 x 480	37.5	75.0	VESA	VGA (75Hz)
640 x 480	43.3	85.0	VESA	VGA (85Hz)
800 x 600	35.2	56.3	VESA	SVGA (56Hz)
800 x 600	37.9	60.3	VESA	SVGA (60Hz)
800 x 600	48.1	72.2	VESA	SVGA (72Hz)
800 x 600	46.9	75.0	VESA	SVGA (75Hz)
800 x 600	53.7	85.1	VESA	SVGA (85Hz)
832 x 624	49.7	74.5		Mac 16" mode
1024 x 768	48.4	60.0	VESA	XGA (60Hz)
1024 x 768	56.5	70.1	VESA	XGA (70Hz)
1024 x 768	60.0	75.0	VESA	XGA (75Hz)
1024 x 768	68.7	85.0	VESA	XGA (85Hz)
1152 x 864	67.5	75.0	VESA	1152 x 864 (75Hz)
1280 x 960	60.0	60.0	VESA	1280 x 960 (60Hz)
1280 x 1024	64.0	60.0	VESA	SXGA (60Hz)
1280 x 1024	80.0	75.0	VESA	SXGA (75Hz)
1280 x 1024	91.1	85.0	VESA	SXGA (85Hz)
1600 x 1200	75.0	60.0	VESA	UXGA (60Hz)
1280 x 768	47.7	60.0	VESA	W-XGA (60Hz)
1400 x 1050	65.2	60.0	VESA	SXGA+ (60Hz)

- NOTE**
- Be sure to check jack type, signal level, timing and resolution before connecting this projector to a PC.
  - Some PCs may have multiple display screen modes. Use of some of these modes will not be possible with this projector.
  - Depending on the input signal, full-size display may not be possible in some cases. Refer to the number of display pixels above.
  - Although the projector can display signals with resolution up to UXGA (1600x1200), the signal will be converted to the projector's panel resolution before being displayed. The best display performance will be achieved if the resolutions of the input signal and projector panel are identical.
  - Automatically adjustment may not function correctly with some input signals.
  - The image may not be displayed correctly when the input sync signal is a composite sync or a sync on G.

## Initial set signals

The following signals are used for the initial settings. The signal timing of some PC models may be different. In such case, adjust the items V POSITION and H POSITION in IMAGE menu.

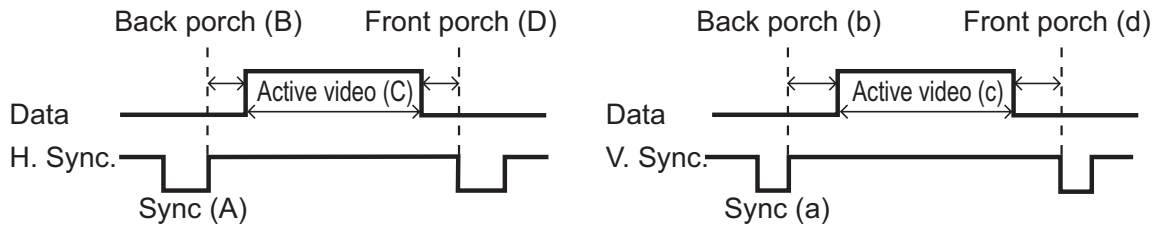

computer Signal	Horizontal signal timing (μs)			
	(A)	(B)	(C)	(D)
TEXT	2.0	3.0	20.3	1.0
VGA (60Hz)	3.8	1.9	25.4	0.6
VGA (72Hz)	1.3	4.1	20.3	0.8
VGA (75Hz)	2.0	3.8	20.3	0.5
VGA (85Hz)	1.6	2.2	17.8	1.6
SVGA (56Hz)	2.0	3.6	22.2	0.7
SVGA (60Hz)	3.2	2.2	20.0	1.0
SVGA (72Hz)	2.4	1.3	16.0	1.1
SVGA (75Hz)	1.6	3.2	16.2	0.3
SVGA (85Hz)	1.1	2.7	14.2	0.6
Mac 16" mode	1.1	3.9	14.5	0.6
XGA (60Hz)	2.1	2.5	15.8	0.4
XGA (70Hz)	1.8	1.9	13.7	0.3
XGA (75Hz)	1.2	2.2	13.0	0.2
XGA (85Hz)	1.0	2.2	10.8	0.5
1152 x 864 (75Hz)	1.2	2.4	10.7	0.6
1280 x 960 (60Hz)	1.0	2.9	11.9	0.9
SXGA (60Hz)	1.0	2.3	11.9	0.4
SXGA (75Hz)	1.1	1.8	9.5	0.1
SXGA (85Hz)	1.0	1.4	8.1	0.4
UXGA (60Hz)	1.2	1.9	9.9	0.4
W-XGA (60Hz)	1.7	2.5	16.0	0.8
SXGA+ (60Hz)	1.2	2.0	11.4	0.7

computer Signal	Vertical signal timing (lines)			
	(a)	(b)	(c)	(d)
TEXT	3	42	400	1
VGA (60Hz)	2	33	480	10
VGA (72Hz)	3	28	480	9
VGA (75Hz)	3	16	480	1
VGA (85Hz)	3	25	480	1
SVGA (56Hz)	2	22	600	1
SVGA (60Hz)	4	23	600	1
SVGA (72Hz)	6	23	600	37
SVGA (75Hz)	3	21	600	1
SVGA (85Hz)	3	27	600	1
Mac 16" mode	3	39	624	1
XGA (60Hz)	6	29	768	3
XGA (70Hz)	6	29	768	3
XGA (75Hz)	3	28	768	1
XGA (85Hz)	3	36	768	1
1152 x 864 (75Hz)	3	32	864	1
1280 x 960 (60Hz)	3	36	960	1
SXGA(60Hz)	3	38	1024	1
SXGA (75Hz)	3	38	1024	1
SXGA (85Hz)	3	44	1024	1
UXGA (60Hz)	3	46	1200	1
W-XGA (60Hz)	3	23	768	1
SXGA+ (60Hz)	3	33	1050	1

Connection to the ports

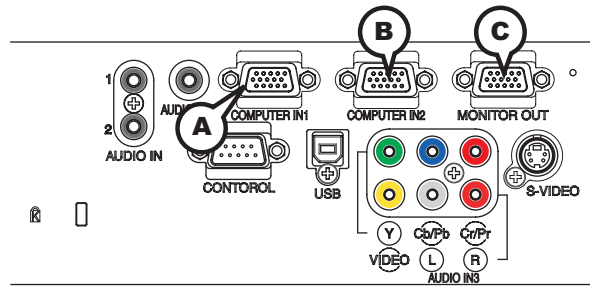

**(A)COMPUTER IN1, (B)COMPUTER IN2, (C)MONITOR OUT**

D-sub 15pin mini shrink jack

- Video signal: RGB separate, Analog, 0.7Vp-p, 75Ω terminated (positive)
- H/V. sync. Signal: TTL level (positive/negative)
- Composite sync. Signal: TTL level

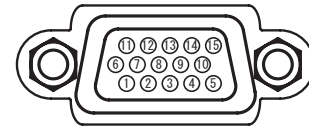

Pin	Signal	Pin	Signal
1	Video Red	10	Ground
2	Video Green	11	(No connection)
3	Video Blue	12	(A): SDA (DDC data)
4	(No connection)		(B), (C): (No connection)
5	Ground	13	H. sync / Composite sync.
6	Ground Red	14	V. sync.
7	Ground Green	15	(A): SCL (DDC clock)
8	Ground Blue		(B), (C): (No connection)
9	(No connection)	-	-



**Connection to the ports (continued)**

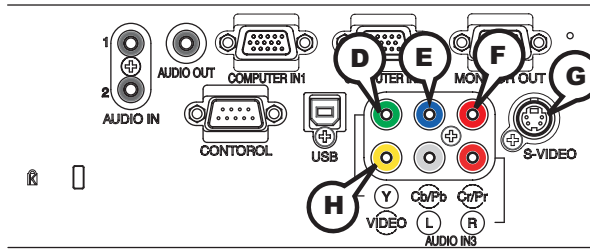

**COMPONENT VIDEO ④ Y, ⑤ Pb/Cb, ⑥ Pr/Cr**

RCA jack x3

- System: 525i(480i), 525p(480p), 625i(576i), 750p(720p), 1125i(1080i)

Port	Signal
Y	Component video Y, 1.0±0.1Vp-p, 75Ω terminator with composite
Pb/Cb	Component video Pb/Cb, 0.7±0.1Vp-p, 75Ω terminator
Pr/Cr	Component video Pr/Cr, 0.7±0.1Vp-p, 75Ω terminator

**⑧ S-VIDEO**

Mini DIN 4pin jack



Pin	Signal
1	Color signal 0.286Vp-p (NTSC, burst), 75Ω terminator Color signal 0.300Vp-p (PAL/SECAM, burst) 75Ω terminator
2	Brightness signal, 1.0Vp-p, 75Ω terminator
3	Ground
4	Ground

**⑨ VIDEO**

RCA jack

- System: NTSC, PAL, SECAM, PAL-M, PAL-N, NTSC4.43
- 1.0±0.1Vp-p, 75Ω terminator

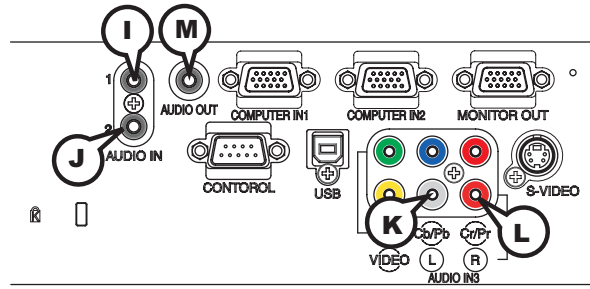

**①AUDIO IN1, ②AUDIO IN2**

Ø3.5 stereo mini jack  
 • 200 mVrms 47kΩ terminator

**AUDIO IN3 ③L, ④R**

RCA jack x2  
 • 200 mVrms 47kΩ terminator

**⑤AUDIO OUT**

Ø3.5 stereo mini jack  
 • 200 mVrms 1kΩ output impedance

**To input SCART RGB signal;**

ex.:

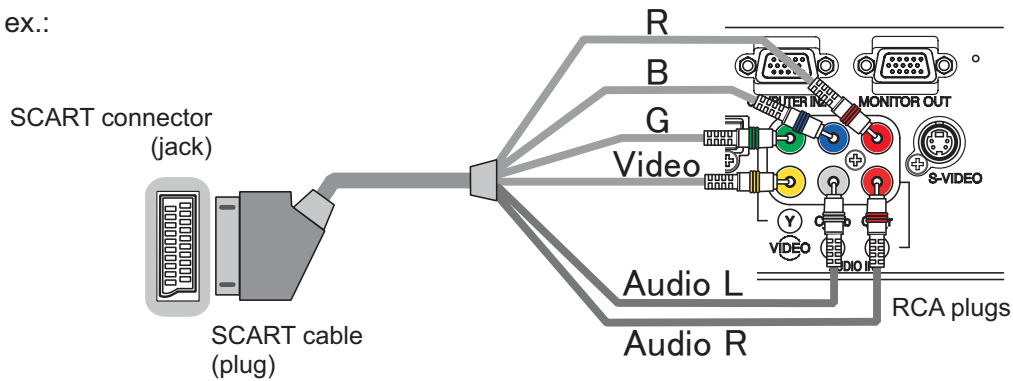

To input SCART RGB signal to the projector, use a SCART to RCA cable.  
 Connect the plugs refer to above ex.. For more reference, please consult your dealer.

**Connection to the ports (continued)**

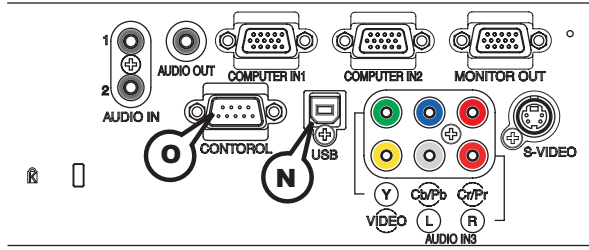

**ⓃUSB**

USB B type jack



Pin	Signal
1	+5V
2	- Data
3	+ Data
4	Ground

**ⓄCONTROL**

D-sub 9pin plug

• About the details of RS-232C communication, please refer to the following page.

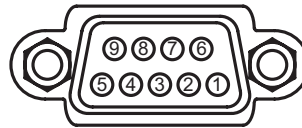

Pin	Signal	Pin	Signal	Pin	Signal
1	(No connection)	4	(No connection)	7	RTS
2	RD	5	Ground	8	CTS
3	TD	6	(No connection)	9	(No connection)

Command Control via the Network

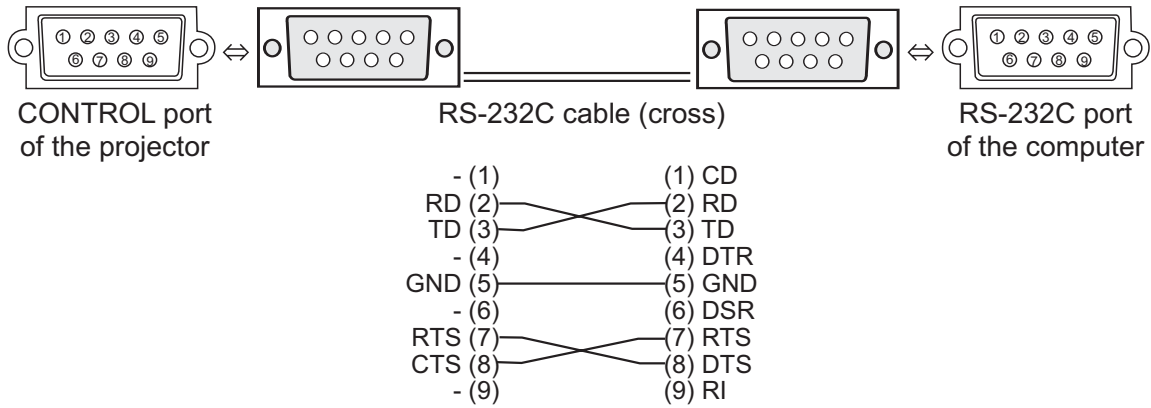

**Connecting the cable**

1. Turn off the projector and the computer.
2. Connect the CONTROL port of the projector with a RS-232C port of the computer by a RS-232C cable (cross). Use the cable that fulfills the specification shown in the previous page.
3. Turn the computer on, and after the computer has started up turn the projector on.

**Communications setting**

19200bps, 8N1

**1. Protocol**

Consist of header (7 bytes) + command data (6 bytes)

**2. Header**

BE + EF + 03 + 06 + 00 + CRC\_low + CRC\_high

CRC\_low: Lower byte of CRC flag for command data

CRC\_high: Upper byte of CRC flag for command data

**3. Command data**

Command data chart

byte_0	byte_1	byte_2	byte_3	byte_4	byte_5
Action		Type		Setting code	
low	high	low	high	low	high

Action (byte\_0 - 1)

Action	Classification	Content
1	Set	Change setting to desired value.
2	Get	Read projector internal setup value.
4	Increment	Increment setup value by 1.
5	Decrement	Decrement setup value by 1.
6	Execute	Run a command.

**Requesting projector status (Get command)**

- (1) Send the following request code from the PC to the projector.  
*Header + Command data ('02H' + '00H' + type (2 bytes) + '00H' + '00H')*
- (2) The projector returns the response code *'1DH' + data (2 bytes)* to the PC.

**Changing the projector settings (Set command)**

- (1) Send the following setting code from the PC to the projector.  
*Header + Command data ('01H' + '00H' + type (2 bytes) + setting code (2 bytes))*
- (2) The projector changes the setting based on the above setting code.
- (3) The projector returns the response code *'06H'* to the PC.

**Using the projector default settings (Reset Command)**

- (1) The PC sends the following default setting code to the projector.  
*Header + Command data ('06H' + '00H' + type (2 bytes) + '00H' + '00H')*
- (2) The projector changes the specified setting to the default value.
- (3) The projector returns the response code *'06H'* to the PC.

**Increasing the projector setting value (Increment command)**

- (1) The PC sends the following increment code to the projector.  
*Header + Command data ('04H' + '00H' + type (2 bytes) + '00H' + '00H')*
- (2) The projector increases the setting value on the above setting code.
- (3) The projector returns the response code *'06H'* to the PC.

**Decreasing the projector setting value (Decrement command)**

- (1) The PC sends the following decrement code to the projector.  
*Header + Command data ('05H' + '00H' + type (2 bytes) + '00H' + '00H')*
- (2) The projector decreases the setting value on the above setting code.
- (3) The projector returns the response code *'06H'* to the PC.

**When the projector cannot understand the received command**

When the projector cannot understand the received command, the error code *'15H'* is sent back to the PC.

Sometimes the projector cannot properly receive the command. In such a case, the command is not executed and the error code *'15H'* is sent back to the PC. If this error code is returned, send the same command again.

**When the projector cannot execute the received command.**

When the projector cannot execute the received command, the error code *'1CH' + 'xxxxH'* is sent back to the PC.

When the data length is greater than indicated by the data length code, the projector ignore the excess data code. Conversely when the data length is shorter than indicated by the data length code, an error code will be returned to the PC.

**NOTE** • Operation cannot be guaranteed when the projector receives an undefined command or data.

- Provide an interval of at least 40ms between the response code and any other code.
- The projector outputs test data when the power supply is switched ON, and when the lamp is lit. Ignore this data.
- Commands are not accepted during warm-up.

**RS-232C communication command table**

Names	Operation Type	Header				Command Data			
		CRC	Action	Type	Setting Code				
Power	Set	Turn off	BE EF	03	06 00	2A D3	01 00	00 60	00 00
		Turn on	BE EF	03	06 00	BA D2	01 00	00 60	01 00
	Get	BE EF	03	06 00	19 D3	02 00	00 60	00 00	
		[Example return] 00 00                      01 00                      02 00 [Off]                              [On]                              [Cool down]							
Input Source	Set	COMPUTER1	BE EF	03	06 00	FE D2	01 00	00 20	00 00
		COMPUTER2	BE EF	03	06 00	3E D0	01 00	00 20	04 00
		COMPONENT	BE EF	03	06 00	AE D1	01 00	00 20	05 00
		S-VIDEO	BE EF	03	06 00	9E D3	01 00	00 20	02 00
	VIDEO	BE EF	03	06 00	6E D3	01 00	00 20	01 00	
	Get	BE EF	03	06 00	CD D2	02 00	00 20	00 00	
Error Status	Get	BE EF	03	06 00	D9 D8	02 00	20 60	00 00	
		[Example return] 00 00                      01 00                      02 00                      03 00 [Normal]                      [Cover error]                      [Fan error]                      [Lamp error] 04 00                      05 00                      06 00                      07 00 [Temp error]                      [Air flow error]                      [Lamp time error]                      [Cold error] 08 00 [Filter error]							
BRIGHTNESS	Get	BE EF	03	06 00	89 D2	02 00	03 20	00 00	
	Increment	BE EF	03	06 00	EF D2	04 00	03 20	00 00	
	Decrement	BE EF	03	06 00	3E D3	05 00	03 20	00 00	
BRIGHTNESS Reset	Execute	BE EF	03	06 00	58 D3	06 00	00 70	00 00	
CONTRAST	Get	BE EF	03	06 00	FD D3	02 00	04 20	00 00	
	Increment	BE EF	03	06 00	9B D3	04 00	04 20	00 00	
	Decrement	BE EF	03	06 00	4A D2	05 00	04 20	00 00	
CONTRAST Reset	Execute	BE EF	03	06 00	A4 D2	06 00	01 70	00 00	
PICTURE MODE	Set	NORMAL	BE EF	03	06 00	23 F6	01 00	BA 30	00 00
		CINEMA	BE EF	03	06 00	B3 F7	01 00	BA 30	01 00
		DYNAMIC	BE EF	03	06 00	E3 F4	01 00	BA 30	04 00
		BOARD(BLACK)	BE EF	03	06 00	E3 EF	01 00	BA 30	20 00
		BOARD(GREEN)	BE EF	03	06 00	73 EE	01 00	BA 30	21 00
		WHITEBOARD	BE EF	03	06 00	83 EE	01 00	BA 30	22 00
		DAYTIME	BE EF	03	06 00	E3 C7	01 00	BA 30	40 00
	Get	BE EF	03	06 00	10 F6	02 00	BA 30	00 00	
		[Example return] 00 00                      01 00                      04 00                      10 00 [Normal]                      [Cinema]                      [Dynamic]                      [Custom] 20 00                      21 00                      22 00                      40 00 [BOARD(BLACK)]                      [BOARD(GREEN)]                      [WHITEBOARD]                      [DAYTIME]							
GAMMA	Set	#1 DEFAULT	BE EF	03	06 00	07 E9	01 00	A1 30	20 00
		#1 CUSTOM	BE EF	03	06 00	07 FD	01 00	A1 30	10 00
		#2 DEFAULT	BE EF	03	06 00	97 E8	01 00	A1 30	21 00
		#2 CUSTOM	BE EF	03	06 00	97 FC	01 00	A1 30	11 00
		#3 DEFAULT	BE EF	03	06 00	67 E8	01 00	A1 30	22 00
		#3 CUSTOM	BE EF	03	06 00	67 FC	01 00	A1 30	12 00
		#4 DEFAULT	BE EF	03	06 00	F7 E9	01 00	A1 30	23 00
		#4 CUSTOM	BE EF	03	06 00	F7 FD	01 00	A1 30	13 00
		#5 DEFAULT	BE EF	03	06 00	C7 EB	01 00	A1 30	24 00
		#5 CUSTOM	BE EF	03	06 00	C7 FF	01 00	A1 30	14 00
		#6 DEFAULT	BE EF	03	06 00	57 EA	01 00	A1 30	25 00
	#6 CUSTOM	BE EF	03	06 00	57 FE	01 00	A1 30	15 00	
	Get	BE EF	03	06 00	F4 F0	02 00	A1 30	00 00	

## RS-232C communication command table (continued)

Names	Operation Type	Header				Command Data			
					CRC	Action	Type	Setting Code	
User Gamma Pattern	Set	Off	BE EF	03	06 00	FB FA	01 00	80 30	00 00
		9 step gray scale	BE EF	03	06 00	6B FB	01 00	80 30	01 00
		15 steps gray scale	BE EF	03	06 00	9B FB	01 00	80 30	02 00
		Ramp	BE EF	03	06 00	0B FA	01 00	80 30	03 00
	Get	BE EF	03	06 00	C8 FA	02 00	80 30	00 00	
User Gamma Point 1	Get	BE EF	03	06 00	08 FE	02 00	90 30	00 00	
	Increment	BE EF	03	06 00	6E FE	04 00	90 30	00 00	
	Decrement	BE EF	03	06 00	BF FF	05 00	90 30	00 00	
User Gamma Point 2	Get	BE EF	03	06 00	F4 FF	02 00	91 30	00 00	
	Increment	BE EF	03	06 00	92 FF	04 00	91 30	00 00	
	Decrement	BE EF	03	06 00	43 FE	05 00	91 30	00 00	
User Gamma Point 3	Get	BE EF	03	06 00	B0 FF	02 00	92 30	00 00	
	Increment	BE EF	03	06 00	D6 FF	04 00	92 30	00 00	
	Decrement	BE EF	03	06 00	07 FE	05 00	92 30	00 00	
User Gamma Point 4	Get	BE EF	03	06 00	4C FE	02 00	93 30	00 00	
	Increment	BE EF	03	06 00	2A FE	04 00	93 30	00 00	
	Decrement	BE EF	03	06 00	FB FF	05 00	93 30	00 00	
User Gamma Point 5	Get	BE EF	03	06 00	38 FF	02 00	94 30	00 00	
	Increment	BE EF	03	06 00	5E FF	04 00	94 30	00 00	
	Decrement	BE EF	03	06 00	8F FE	05 00	94 30	00 00	
User Gamma Point 6	Get	BE EF	03	06 00	C4 FE	02 00	95 30	00 00	
	Increment	BE EF	03	06 00	A2 FE	04 00	95 30	00 00	
	Decrement	BE EF	03	06 00	73 FF	05 00	95 30	00 00	
User Gamma Point 7	Get	BE EF	03	06 00	80 FE	02 00	96 30	00 00	
	Increment	BE EF	03	06 00	E6 FE	04 00	96 30	00 00	
	Decrement	BE EF	03	06 00	37 FF	05 00	96 30	00 00	
User Gamma Point 8	Get	BE EF	03	06 00	7C FF	02 00	97 30	00 00	
	Increment	BE EF	03	06 00	1A FF	04 00	97 30	00 00	
	Decrement	BE EF	03	06 00	CB FE	05 00	97 30	00 00	
COLOR TEMP	Set	HIGH	BE EF	03	06 00	0B F5	01 00	B0 30	03 00
		CUSTOM-1 (HIGH)	BE EF	03	06 00	CB F8	01 00	B0 30	13 00
		MID	BE EF	03	06 00	9B F4	01 00	B0 30	02 00
		CUSTOM-2 (MID)	BE EF	03	06 00	5B F9	01 00	B0 30	12 00
		LOW	BE EF	03	06 00	6B F4	01 00	B0 30	01 00
		CUSTOM-3 (LOW)	BE EF	03	06 00	AB F9	01 00	B0 30	11 00
		Hi-BRIGHT-1	BE EF	03	06 00	3B F2	01 00	B0 30	08 00
		CUSTOM-4 (Hi-BRIGHT-1)	BE EF	03	06 00	FB FF	01 00	B0 30	18 00
		Hi-BRIGHT-2	BE EF	03	06 00	AB F3	01 00	B0 30	09 00
		CUSTOM-5 (Hi-BRIGHT-2)	BE EF	03	06 00	6B FE	01 00	B0 30	19 00
	Hi-BRIGHT-3	BE EF	03	06 00	5B F3	01 00	B0 30	0A 00	
CUSTOM-6 (Hi-BRIGHT-3)	BE EF	03	06 00	9B FE	01 00	B0 30	1A 00		
	Get	BE EF	03	06 00	C8 F5	02 00	B0 30	00 00	
COLOR TEMP GAIN R	Get	BE EF	03	06 00	34 F4	02 00	B1 30	00 00	
	Increment	BE EF	03	06 00	52 F4	04 00	B1 30	00 00	
	Decrement	BE EF	03	06 00	83 F5	05 00	B1 30	00 00	
COLOR TEMP GAIN G	Get	BE EF	03	06 00	70 F4	02 00	B2 30	00 00	
	Increment	BE EF	03	06 00	16 F4	04 00	B2 30	00 00	
	Decrement	BE EF	03	06 00	C7 F5	05 00	B2 30	00 00	

## RS-232C communication command table (continued)

Names	Operation Type	Header				Command Data			
					CRC	Action	Type	Setting Code	
COLOR TEMP GAIN B	Get	BE EF	03	06 00	8C F5	02 00	B3 30	00 00	
	Increment	BE EF	03	06 00	EA F5	04 00	B3 30	00 00	
	Decrement	BE EF	03	06 00	3B F4	05 00	B3 30	00 00	
COLOR TEMP OFFSET R	Get	BE EF	03	06 00	04 F5	02 00	B5 30	00 00	
	Increment	BE EF	03	06 00	62 F5	04 00	B5 30	00 00	
	Decrement	BE EF	03	06 00	B3 F4	05 00	B5 30	00 00	
COLOR TEMP OFFSET G	Get	BE EF	03	06 00	40 F5	02 00	B6 30	00 00	
	Increment	BE EF	03	06 00	26 F5	04 00	B6 30	00 00	
	Decrement	BE EF	03	06 00	F7 F4	05 00	B6 30	00 00	
COLOR TEMP OFFSET B	Get	BE EF	03	06 00	BC F4	02 00	B7 30	00 00	
	Increment	BE EF	03	06 00	DA F4	04 00	B7 30	00 00	
	Decrement	BE EF	03	06 00	0B F5	05 00	B7 30	00 00	
COLOR	Get	BE EF	03	06 00	B5 72	02 00	02 22	00 00	
	Increment	BE EF	03	06 00	D3 72	04 00	02 22	00 00	
	Decrement	BE EF	03	06 00	02 73	05 00	02 22	00 00	
COLOR Reset	Execute	BE EF	03	06 00	80 D0	06 00	0A 70	00 00	
TINT	Get	BE EF	03	06 00	49 73	02 00	03 22	00 00	
	Increment	BE EF	03	06 00	2F 73	04 00	03 22	00 00	
	Decrement	BE EF	03	06 00	FE 72	05 00	03 22	00 00	
TINT Reset	Execute	BE EF	03	06 00	7C D1	06 00	0B 70	00 00	
SHARPNESS	Get	BE EF	03	06 00	F1 72	02 00	01 22	00 00	
	Increment	BE EF	03	06 00	97 72	04 00	01 22	00 00	
	Decrement	BE EF	03	06 00	46 73	05 00	01 22	00 00	
SHARPNESS Reset	Execute	BE EF	03	06 00	C4 D0	06 00	09 70	00 00	
MY MEMORY Load	Set	1	BE EF	03	06 00	0E D7	01 00	14 20	00 00
		2	BE EF	03	06 00	9E D6	01 00	14 20	01 00
		3	BE EF	03	06 00	6E D6	01 00	14 20	02 00
		4	BE EF	03	06 00	FE D7	01 00	14 20	03 00
MY MEMORY Save	Set	1	BE EF	03	06 00	F2 D6	01 00	15 20	00 00
		2	BE EF	03	06 00	62 D7	01 00	15 20	01 00
		3	BE EF	03	06 00	92 D7	01 00	15 20	02 00
		4	BE EF	03	06 00	02 D6	01 00	15 20	03 00
PROGRESSIVE	Set	TURN OFF	BE EF	03	06 00	4A 72	01 00	07 22	00 00
		TV	BE EF	03	06 00	DA 73	01 00	07 22	01 00
		FILM	BE EF	03	06 00	2A 73	01 00	07 22	02 00
	Get	BE EF	03	06 00	79 72	02 00	07 22	00 00	
VIDEO NR	Set	LOW	BE EF	03	06 00	26 72	01 00	06 22	01 00
		MID	BE EF	03	06 00	D6 72	01 00	06 22	02 00
		HIGH	BE EF	03	06 00	46 73	01 00	06 22	03 00
	Get	BE EF	03	06 00	85 73	02 00	06 22	00 00	
ASPECT	Set	4:3	BE EF	03	06 00	9E D0	01 00	08 20	00 00
		16:9	BE EF	03	06 00	0E D1	01 00	08 20	01 00
		14:9	BE EF	03	06 00	CE D6	01 00	08 20	09 00
		SMALL	BE EF	03	06 00	FE D1	01 00	08 20	02 00
		NORMAL	BE EF	03	06 00	5E DD	01 00	08 20	10 00
	Get	BE EF	03	06 00	AD D0	02 00	08 20	00 00	

(continued on next page)



## RS-232C communication command table (continued)

Names	Operation Type	Header				Command Data			
					CRC	Action	Type	Setting Code	
OVER SCAN	Get	BE EF	03	06 00	91 70	02 00	09 22	00 00	
	Increment	BE EF	03	06 00	F7 70	04 00	09 22	00 00	
	Decrement	BE EF	03	06 00	26 71	05 00	09 22	00 00	
OVER SCAN Reset	Execute	BE EF	03	06 00	EC D9	06 00	27 70	00 00	
V POSITION	Get	BE EF	03	06 00	0D 83	02 00	00 21	00 00	
	Increment	BE EF	03	06 00	6B 83	04 00	00 21	00 00	
	Decrement	BE EF	03	06 00	BA 82	05 00	00 21	00 00	
V POSITION Reset	Execute	BE EF	03	06 00	E0 D2	06 00	02 70	00 00	
H POSITION	Get	BE EF	03	06 00	F1 82	02 00	01 21	00 00	
	Increment	BE EF	03	06 00	97 82	04 00	01 21	00 00	
	Decrement	BE EF	03	06 00	46 83	05 00	01 21	00 00	
H POSITION Reset	Execute	BE EF	03	06 00	1C D3	06 00	03 70	00 00	
H PHASE	Get	BE EF	03	06 00	49 83	02 00	03 21	00 00	
	Increment	BE EF	03	06 00	2F 83	04 00	03 21	00 00	
	Decrement	BE EF	03	06 00	FE 82	05 00	03 21	00 00	
H SIZE	Get	BE EF	03	06 00	B5 82	02 00	02 21	00 00	
	Increment	BE EF	03	06 00	D3 82	04 00	02 21	00 00	
	Decrement	BE EF	03	06 00	02 83	05 00	02 21	00 00	
H SIZE Reset	Execute	BE EF	03	06 00	68 D2	06 00	04 70	00 00	
AUTO ADJUST	Execute	BE EF	03	06 00	91 D0	06 00	0A 20	00 00	
COLOR SPACE	Set	AUTO	BE EF	03	06 00	0E 72	01 00	04 22	00 00
		RGB	BE EF	03	06 00	9E 73	01 00	04 22	01 00
		SMPTE240	BE EF	03	06 00	6E 73	01 00	04 22	02 00
		REC709	BE EF	03	06 00	FE 72	01 00	04 22	03 00
		REC601	BE EF	03	06 00	CE 70	01 00	04 22	04 00
	Get	BE EF	03	06 00	3D 72	02 00	04 22	00 00	
COMPONENT	Set	COMPONENT	BE EF	03	06 00	4A D7	01 00	17 20	00 00
		SCART RGB	BE EF	03	06 00	DA D6	01 00	17 20	01 00
	Get	BE EF	03	06 00	79 D7	02 00	17 20	00 00	
C-VIDEO FORMAT	Set	AUTO	BE EF	03	06 00	A2 70	01 00	11 22	0A 00
		NTSC	BE EF	03	06 00	C2 74	01 00	11 22	04 00
		PAL	BE EF	03	06 00	52 75	01 00	11 22	05 00
		SECAM	BE EF	03	06 00	52 70	01 00	11 22	09 00
		NTSC4.43	BE EF	03	06 00	62 77	01 00	11 22	02 00
		M-PAL	BE EF	03	06 00	C2 71	01 00	11 22	08 00
		N-PAL	BE EF	03	06 00	32 74	01 00	11 22	07 00
	Get	BE EF	03	06 00	31 76	02 00	11 22	00 00	
S-VIDEO FORMAT	Set	AUTO	BE EF	03	06 00	E6 70	01 00	12 22	0A 00
		NTSC	BE EF	03	06 00	86 74	01 00	12 22	04 00
		PAL	BE EF	03	06 00	16 75	01 00	12 22	05 00
		SECAM	BE EF	03	06 00	16 70	01 00	12 22	09 00
		NTSC4.43	BE EF	03	06 00	26 77	01 00	12 22	02 00
		M-PAL	BE EF	03	06 00	86 71	01 00	12 22	08 00
		N-PAL	BE EF	03	06 00	76 74	01 00	12 22	07 00
	Get	BE EF	03	06 00	75 76	02 00	12 22	00 00	
FRAME LOCK	Set	TURN OFF	BE EF	03	06 00	CB D6	01 00	14 30	00 00
		TURN ON	BE EF	03	06 00	5B D7	01 00	14 30	01 00
	Get	BE EF	03	06 00	F8 D6	02 00	14 30	00 00	

## RS-232C communication command table (continued)

Names	Operation Type	Header				Command Data			
					CRC	Action	Type	Setting Code	
COMPUTER IN1	Set	SYNC ON G ON	BE EF	03	06 00	CE D6	01 00	10 20	03 00
		SYNC ON G OFF	BE EF	03	06 00	5E D7	01 00	10 20	02 00
	Get	BE EF	03	06 00	0D D6	02 00	10 20	00 00	
COMPUTER IN2	Set	SYNC ON G ON	BE EF	03	06 00	32 D7	01 00	11 20	03 00
		SYNC ON G OFF	BE EF	03	06 00	A2 D6	01 00	11 20	02 00
	Get	BE EF	03	06 00	F1 D7	02 00	11 20	00 00	
KEYSTONE V	Get	BE EF	03	06 00	B9 D3	02 00	07 20	00 00	
	Increment	BE EF	03	06 00	DF D3	04 00	07 20	00 00	
	Decrement	BE EF	03	06 00	0E D2	05 00	07 20	00 00	
KEYSTONE V Reset	Execute	BE EF	03	06 00	08 D0	06 00	0C 70	00 00	
AUTO KEYSTONE EXECUTE	Execute	BE EF	03	06 00	E5 D1	06 00	0D 20	00 00	
WHISPER	Set	NORMAL	BE EF	03	06 00	3B 23	01 00	00 33	00 00
		WHISPER	BE EF	03	06 00	AB 22	01 00	00 33	01 00
	Get	BE EF	03	06 00	08 23	02 00	00 33	00 00	
MIRROR	Set	NORMAL	BE EF	03	06 00	C7 D2	01 00	01 30	00 00
		H:INVERT	BE EF	03	06 00	57 D3	01 00	01 30	01 00
		V:INVERT	BE EF	03	06 00	A7 D3	01 00	01 30	02 00
		H&V:INVERT	BE EF	03	06 00	37 D2	01 00	01 30	03 00
	Get	BE EF	03	06 00	F4 D2	02 00	01 30	00 00	
VOLUME-COMPUTER1	Get	BE EF	03	06 00	CD CC	02 00	60 20	00 00	
	Increment	BE EF	03	06 00	AB CC	04 00	60 20	00 00	
	Decrement	BE EF	03	06 00	7A CD	05 00	60 20	00 00	
VOLUME-COMPUTER2	Get	BE EF	03	06 00	FD CD	02 00	64 20	00 00	
	Increment	BE EF	03	06 00	9B CD	04 00	64 20	00 00	
	Decrement	BE EF	03	06 00	4A CC	05 00	64 20	00 00	
VOLUME-COMPONENT	Get	BE EF	03	06 00	01 CC	02 00	65 20	00 00	
	Increment	BE EF	03	06 00	67 CC	04 00	65 20	00 00	
	Decrement	BE EF	03	06 00	B6 CD	05 00	65 20	00 00	
VOLUME-S-Video	Get	BE EF	03	06 00	75 CD	02 00	62 20	00 00	
	Increment	BE EF	03	06 00	13 CD	04 00	62 20	00 00	
	Decrement	BE EF	03	06 00	C2 CC	05 00	62 20	00 00	
VOLUME-Video	Get	BE EF	03	06 00	31 CD	02 00	61 20	00 00	
	Increment	BE EF	03	06 00	57 CD	04 00	61 20	00 00	
	Decrement	BE EF	03	06 00	86 CC	05 00	61 20	00 00	
MUTE	Set	TURN OFF	BE EF	03	06 00	46 D3	01 00	02 20	00 00
		TURN ON	BE EF	03	06 00	D6 D2	01 00	02 20	01 00
	Get	BE EF	03	06 00	75 D3	02 00	02 20	00 00	
SPEAKER	Set	TURN ON	BE EF	03	06 00	FE D4	01 00	1C 20	01 00
		TURN OFF	BE EF	03	06 00	6E D5	01 00	1C 20	00 00
	Get	BE EF	03	06 00	5D D5	02 00	1C 20	00 00	

(continued on next page)

## RS-232C communication command table (continued)

Names	Operation Type	Header				Command Data			
					CRC	Action	Type	Setting Code	
AUDIO-COMPUTER1	Set	AUDIO1	BE EF	03	06 00	6E DC	01 00	30 20	01 00
		AUDIO2	BE EF	03	06 00	9E DC	01 00	30 20	02 00
		AUDIO3	BE EF	03	06 00	0E DD	01 00	30 20	03 00
		Turn off	BE EF	03	06 00	FE DD	01 00	30 20	00 00
	Get	BE EF	03	06 00	CD DD	02 00	30 20	00 00	
AUDIO-COMPUTER2	Set	AUDIO1	BE EF	03	06 00	5E DD	01 00	34 20	01 00
		AUDIO2	BE EF	03	06 00	AE DD	01 00	34 20	02 00
		AUDIO3	BE EF	03	06 00	3E DC	01 00	34 20	03 00
		Turn off	BE EF	03	06 00	CE DC	01 00	34 20	00 00
	Get	BE EF	03	06 00	FD DC	02 00	34 20	00 00	
AUDIO-COMPONENT	Set	AUDIO1	BE EF	03	06 00	A2 DC	01 00	35 20	01 00
		AUDIO2	BE EF	03	06 00	52 DC	01 00	35 20	02 00
		AUDIO3	BE EF	03	06 00	C2 DD	01 00	35 20	03 00
		Turn off	BE EF	03	06 00	32 DD	01 00	35 20	00 00
	Get	BE EF	03	06 00	01 DD	02 00	35 20	00 00	
AUDIO-S-VIDEO	Set	AUDIO1	BE EF	03	06 00	D6 DD	01 00	32 20	01 00
		AUDIO2	BE EF	03	06 00	26 DD	01 00	32 20	02 00
		AUDIO3	BE EF	03	06 00	B6 DC	01 00	32 20	03 00
		Turn off	BE EF	03	06 00	46 DC	01 00	32 20	00 00
	Get	BE EF	03	06 00	75 DC	02 00	32 20	00 00	
AUDIO-VIDEO	Set	AUDIO1	BE EF	03	06 00	92 DD	01 00	31 20	01 00
		AUDIO2	BE EF	03	06 00	62 DD	01 00	31 20	02 00
		AUDIO3	BE EF	03	06 00	F2 DC	01 00	31 20	03 00
		Turn off	BE EF	03	06 00	02 DC	01 00	31 20	00 00
	Get	BE EF	03	06 00	31 DC	02 00	31 20	00 00	
IR REMOTE FREQ. NORMAL	Set	Off	BE EF	03	06 00	FF 3D	01 00	30 26	00 00
		On	BE EF	03	06 00	6F 3C	01 00	30 26	01 00
	Get	BE EF	03	06 00	CC 3D	02 00	30 26	00 00	
IR REMOTE FREQ. HIGH	Set	Off	BE EF	03	06 00	03 3C	01 00	31 26	00 00
		On	BE EF	03	06 00	93 3D	01 00	31 26	01 00
	Get	BE EF	03	06 00	30 3C	02 00	31 26	00 00	

(continued on next page)

## RS-232C communication command table (continued)

Names	Operation Type	Header				Command Data			
					CRC	Action	Type	Setting Code	
LANGUAGE	Set	ENGLISH	BE EF	03	06 00	F7 D3	01 00	05 30	00 00
		FRANÇAIS	BE EF	03	06 00	67 D2	01 00	05 30	01 00
		DEUTSCH	BE EF	03	06 00	97 D2	01 00	05 30	02 00
		ESPAÑOL	BE EF	03	06 00	07 D3	01 00	05 30	03 00
		ITALIANO	BE EF	03	06 00	37 D1	01 00	05 30	04 00
		NORSK	BE EF	03	06 00	A7 D0	01 00	05 30	05 00
		NEDERLANDS	BE EF	03	06 00	57 D0	01 00	05 30	06 00
		PORTUGUÊS	BE EF	03	06 00	C7 D1	01 00	05 30	07 00
		日本語	BE EF	03	06 00	37 D4	01 00	05 30	08 00
		简体中文	BE EF	03	06 00	A7 D5	01 00	05 30	09 00
		繁體中文	BE EF	03	06 00	37 DE	01 00	05 30	10 00
		한글	BE EF	03	06 00	57 D5	01 00	05 30	0A 00
		SVENSKA	BE EF	03	06 00	C7 D4	01 00	05 30	0B 00
		РУССКИЙ	BE EF	03	06 00	F7 D6	01 00	05 30	0C 00
		SUOMI	BE EF	03	06 00	67 D7	01 00	05 30	0D 00
POLSKI	BE EF	03	06 00	97 D7	01 00	05 30	0E 00		
TÜRKÇE	BE EF	03	06 00	07 D6	01 00	05 30	0F 00		
	Get	BE EF	03	06 00	C4 D3	02 00	05 30	00 00	
MENU POSITION H	Get	BE EF	03	06 00	04 D7	02 00	15 30	00 00	
	Increment	BE EF	03	06 00	62 D7	04 00	15 30	00 00	
	Decrement	BE EF	03	06 00	B3 D6	05 00	15 30	00 00	
MENU POSITION H Reset	Execute	BE EF	03	06 00	DC C6	06 00	43 70	00 00	
MENU POSITION V	Get	BE EF	03	06 00	40 D7	02 00	16 30	00 00	
	Increment	BE EF	03	06 00	26 D7	04 00	16 30	00 00	
	Decrement	BE EF	03	06 00	F7 D6	05 00	16 30	00 00	
MENU POSITION V Reset	Execute	BE EF	03	06 00	A8 C7	06 00	44 70	00 00	
BLANK	Set	MyScreen	BE EF	03	06 00	FB CA	01 00	00 30	20 00
		ORIGINAL	BE EF	03	06 00	FB E2	01 00	00 30	40 00
		BLUE	BE EF	03	06 00	CB D3	01 00	00 30	03 00
		WHITE	BE EF	03	06 00	6B D0	01 00	00 30	05 00
		BLACK	BE EF	03	06 00	9B D0	01 00	00 30	06 00
	Get	BE EF	03	06 00	08 D3	02 00	00 30	00 00	
BLANK On/Off	Set	TURN OFF	BE EF	03	06 00	FB D8	01 00	20 30	00 00
		TURN ON	BE EF	03	06 00	6B D9	01 00	20 30	01 00
	Get	BE EF	03	06 00	C8 D8	02 00	20 30	00 00	
START UP	Set	MyScreen	BE EF	03	06 00	CB CB	01 00	04 30	20 00
		ORIGINAL	BE EF	03	06 00	0B D2	01 00	04 30	00 00
		TURN OFF	BE EF	03	06 00	9B D3	01 00	04 30	01 00
	Get	BE EF	03	06 00	38 D2	02 00	04 30	00 00	
MyScreen LOCK	Set	TURN OFF	BE EF	03	06 00	3B EF	01 00	C0 30	00 00
		TURN ON	BE EF	03	06 00	AB EE	01 00	C0 30	01 00
	Get	BE EF	03	06 00	08 EF	02 00	C0 30	00 00	
MESSAGE	Set	TURN OFF	BE EF	03	06 00	8F D6	01 00	17 30	00 00
		TURN ON	BE EF	03	06 00	1F D7	01 00	17 30	01 00
	Get	BE EF	03	06 00	BC D6	02 00	17 30	00 00	
AUTO SEARCH	Set	TURN OFF	BE EF	03	06 00	B6 D6	01 00	16 20	00 00
		TURN ON	BE EF	03	06 00	26 D7	01 00	16 20	01 00
	Get	BE EF	03	06 00	85 D6	02 00	16 20	00 00	

(continued on next page)

## Command Control via the Network (continued)

## RS-232C communication command table (continued)

Names	Operation Type	Header				Command Data			
					CRC	Action	Type	Setting Code	
AUTO KEYSTONE	Set	TURN OFF	BE EF	03	06 00	EA D1	01 00	0F 20	00 00
		TURN ON	BE EF	03	06 00	7A D0	01 00	0F 20	01 00
	Get	BE EF	03	06 00	D9 D1	02 00	0F 20	00 00	
AUTO ON	Set	TURN OFF	BE EF	03	06 00	3B 89	01 00	20 31	00 00
		TURN ON	BE EF	03	06 00	AB 88	01 00	20 31	01 00
	Get	BE EF	03	06 00	08 89	02 00	20 31	00 00	
AUTO OFF	Get	BE EF	03	06 00	08 86	02 00	10 31	00 00	
	Increment	BE EF	03	06 00	6E 86	04 00	10 31	00 00	
	Decrement	BE EF	03	06 00	BF 87	05 00	10 31	00 00	
LAMP TIME	Get	BE EF	03	06 00	C2 FF	02 00	90 10	00 00	
LAMP TIME Reset	Execute	BE EF	03	06 00	58 DC	06 00	30 70	00 00	
FILTER TIME	Get	BE EF	03	06 00	C2 F0	02 00	A0 10	00 00	
FILER TIME Reset	Execute	BE EF	03	06 00	98 C6	06 00	40 70	00 00	
MY BUTTON-1	COMPUTER1	BE EF	03	06 00	3A 33	01 00	00 36	00 00	
	COMPUTER2	BE EF	03	06 00	FA 31	01 00	00 36	04 00	
	COMPONENT	BE EF	03	06 00	6A 30	01 00	00 36	05 00	
	S-VIDEO	BE EF	03	06 00	5A 32	01 00	00 36	02 00	
	VIDEO	BE EF	03	06 00	AA 32	01 00	00 36	01 00	
	INFORMATION	BE EF	03	06 00	FA 3E	01 00	00 36	10 00	
	AUTO KEYSTONE EXECUTE	BE EF	03	06 00	6A 3F	01 00	00 36	11 00	
	MY MEMORY	BE EF	03	06 00	9A 3F	01 00	00 36	12 00	
	PICTURE MODE	BE EF	03	06 00	0A 3E	01 00	00 36	13 00	
	FILTER RESET	BE EF	03	06 00	3A 3C	01 00	00 36	14 00	
	VOLUME +	BE EF	03	06 00	CA 3C	01 00	00 36	17 00	
	VOLUME -	BE EF	03	06 00	3A 39	01 00	00 36	18 00	
	Get	BE EF	03	06 00	09 33	02 00	00 36	00 00	
	MY BUTTON-2	COMPUTER1	BE EF	03	06 00	C6 32	01 00	01 36	00 00
COMPUTER2		BE EF	03	06 00	06 30	01 00	01 36	04 00	
COMPONENT		BE EF	03	06 00	96 31	01 00	01 36	05 00	
S-VIDEO		BE EF	03	06 00	A6 33	01 00	01 36	02 00	
VIDEO		BE EF	03	06 00	56 33	01 00	01 36	01 00	
INFORMATION		BE EF	03	06 00	06 3F	01 00	01 36	10 00	
AUTO KEYSTONE EXECUTE		BE EF	03	06 00	96 3E	01 00	01 36	11 00	
MY MEMORY		BE EF	03	06 00	66 3E	01 00	01 36	12 00	
PICTURE MODE		BE EF	03	06 00	F6 3F	01 00	01 36	13 00	
FILTER RESET		BE EF	03	06 00	C6 3D	01 00	01 36	14 00	
VOLUME +		BE EF	03	06 00	36 3D	01 00	01 36	17 00	
VOLUME -		BE EF	03	06 00	C6 38	01 00	01 36	18 00	
Get		BE EF	03	06 00	F5 32	02 00	01 36	00 00	
MAGNIFY		Get	BE EF	03	06 00	7C D2	02 00	07 30	00 00
	Increment	BE EF	03	06 00	1A D2	04 00	07 30	00 00	
	Decrement	BE EF	03	06 00	CB D3	05 00	07 30	00 00	
FREEZE	Set	NORMAL	BE EF	03	06 00	83 D2	01 00	02 30	00 00
		FREEZE	BE EF	03	06 00	13 D3	01 00	02 30	01 00
	Get	BE EF	03	06 00	B0 D2	02 00	02 30	00 00	

#### **Intended Use**

Before operating this machine, please read this entire manual thoroughly. The 3M™ Multimedia Projectors are designed, built, and tested for use indoors, using 3M lamps, 3M ceiling mount hardware, and nominal local voltages.

The use of other replacement lamps, outdoor operation, or different voltages has not been tested and could damage the projector peripheral equipment and/or create a potentially unsafe operating condition.

3M Multimedia projectors and Wall Display Systems are designed to operate in a normal office environment.

- 16° to 29°C (60° to 85° F)
- 10- 80 %RH (without condensation)
- 0- 1828 m (0-6000 feet) above sea level

The ambient operating environment should be free of airborne smoke, grease, oil and other contaminants that can affect the operation or performance of the projector.

Use of this product in adverse conditions will void the product warranty.

Let us help you make the most of your next presentation. We offer everything from presentation supplies to tips for better meetings. And we're the only transparency manufacturer that offers a recycling program for your used transparencies. For late-breaking news, handy reference and free product samples, call us toll-free in the continental United States and Canada, 24 hours a day, or visit our Internet Website.

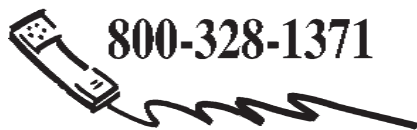

<http://www.3m.com/meetings>  
e-mail: [meetings@mmm.com](mailto:meetings@mmm.com)

**3M Austin Center**  
Building A145-5N-01  
6801 River Place Blvd.  
Austin, TX 78726-9000

**3M Canada**  
P.O. Box 5757  
London, Ontario  
N6A 4T1

**3M Mexico, S.A. de C.V.**  
Apartado Postal 14-139  
Mexico, D.F. 07000  
Mexico

**3M Europe**  
Boulevard de l'Oise  
95006 Cergy Pontoise Cedex  
France