

myprojectorlamps.com

**The most trusted, dependable name
in projector lamp sales.**



<http://www.myprojectorlamps.com>



<http://www.myprojectorlamps.ca>



<http://www.myprojectorlamps.eu>

The following projector manual has not been modified or altered in any way.



MP8760 Multimedia Projector Operator's Guide

Projecteur multimédia MP8760 Guide d'utilisation

MP8760 Multimedia-Projektor Bedienerhandbuch

Proyector de medios múltiples (multimedia) MP8760 Guía del operador

Guida dell'operatore del proiettore multimediale MP8760

Bruksanvisning för MP8760 Multimediaprojektor

3M MP8760 Multimediaprojector Gebruiksaanwijzing

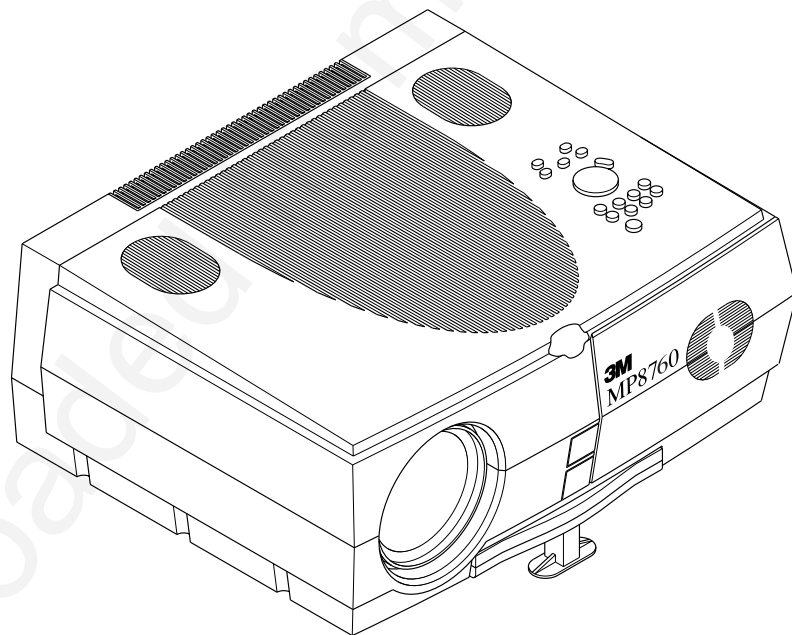

MP8760 Multimedia Projector

Table of Contents

SAFEGUARDS	ii
WARRANTY	iv
SECTION 1: UNPACK	1
1-1. CONTENTS OF SHIPPING BOX.....	1
1-2. KEEP YOUR PACKING MATERIALS.....	1
1-3. WHAT'S NEXT?.....	1
SECTION 2: PRODUCTION DESCRIPTION	2
2-1. MACHINE CHARACTERISTICS	2
2-2. PARTS IDENTIFICATION LIST	2
SECTION 3: SET UP/CONNECTIONS	3
3-1. TERMINAL CONNECTION PANEL	3
3-2. OPERATOR TOUCH PANEL KEYPAD	3
3-3. MOUSE CONNECTION.....	4
3-4. CABLE CONNECTIONS.....	4
3-5. IMAGE SIZE (PROJECTOR-TO-SCREEN DISTANCE).....	5
3-6. IMAGE HEIGHT	6
SECTION 4: OPERATING INSTRUCTIONS	7
4-1. POWER UP PROJECTOR	7
4-2. STANDBY MODE	8
4-3. PROJECTOR POWER DOWN	8
4-4. USING SYSTEM MENUS.....	8
4-5. MENU ADJUSTMENTS/SETTINGS	9
SECTION 5: REMOTE CONTROL	13
5-1. REMOTE CONTROL FUNCTIONS.....	13
5-2. MEANING OF THE ICONS.....	14
5-3. BATTERY REPLACEMENT.....	16
SECTION 6: MAINTENANCE	17
6-1. REPLACING THE AIR FILTER.....	17
6-2. REPLACING PROJECTION LAMP	18
6-3. LAMP LIFE INDICATOR.....	19
6-4. CLEANING THE PROJECTOR	19
SECTION 7: TROUBLESHOOTING	20
7-1. TROUBLESHOOTING PROBLEMS AND SOLUTIONS	20
7-2. SERVICE INFORMATION	22
SECTION 8: PRODUCT SPECIFICATIONS	23
8-1. TECHNICAL SPECIFICATIONS	23
8-2. ACCESSORY & SPARE PARTS LIST	24
8-3. HOW TO ORDER	24
APPENDIX	25

Safeguards

INTENDED USE

Before operating the machine, please read the entire manual thoroughly. The 3M Multimedia Projector MP8760 was designed, built, and tested for use indoors, using 3M lamps, 3M ceiling mount hardware and nominal local voltages. The use of other replacement lamps, outdoor operation, operation in environments containing heavy cigarette smoke or different voltages has not been tested and could damage the projector or peripheral equipment and/or create a potentially unsafe operating condition.

IMPORTANT SAFEGUARDS



1. Read and understand all instructions before using. Pay particular attention to areas where this symbol  is shown.

WARNING

Indicates a potentially hazardous situation which, if not avoided, could result in death or serious injury.

 **Caution** - Indicates a potentially hazardous situation which, if not avoided, could result in minor or moderate injury. It may also be used to alert against unsafe practices.

✓ **Note** - Used to emphasis important conditions or details.

2. Close supervision is necessary when any appliance is used by or near children. Do not leave appliance unattended while in use.
3. Never look directly into the projector lens when the lamp is on. The NTP (New Tip Placement) lamp produces a strong light that could damage your eyesight.
-  4. Care must be taken as burns can occur from touching hot parts.
5. Do not operate appliance with a damaged cord or if the appliance has been dropped or damaged - until it has been examined by a qualified service technician.
-  6. Position the cord so that it will not be tripped over, pulled or contact hot surfaces.
7. If an extension cord is necessary, a cord with an earth/ground and a current rating at least equal to that of the appliance should be used. Cords rated for less amperage than the appliance may overheat.
8. Always unplug appliance from electrical outlet before cleaning and servicing and when not in use. Grasp plug and pull to disconnect.
9. To reduce the risk of electric shock, do not immerse this appliance in water or other liquids.
10. To reduce the risk of electric shock, do not disassemble this appliance or attempt to service it yourself. Take it to a qualified technician when service or repair work is required. Incorrect reassembly can cause electric shock when the appliance is subsequently used.
11. The use of an accessory attachment not recommended by the manufacturer may cause a risk of fire, electric shock, or injury to persons.
12. Connect this appliance to a grounded outlet.
-  13. This unit is equipped with optical lenses and should not be exposed to direct sunlight.
14. Keep ventilation openings free of any obstructions.
15. Always operate machine on a flat, sturdy surface.
16. The projection lamp contains mercury. Always dispose of it in a proper manner according to local regulations.
17. To avoid premature lamp failure, do not change the mounting position of the projector (desktop ⇒ ceiling mount or ceiling mount ⇒ desktop mount) and continue to use the same lamp.
18. To avoid deposits from forming on internal components, do not operate projector in extremely humid environments (RH > 80%) or near any type of fine mist.

PRODUCT SAFETY LABELS

The following safety labels are used on or within the MP8760 projector to alert you to items or areas requiring your attention:

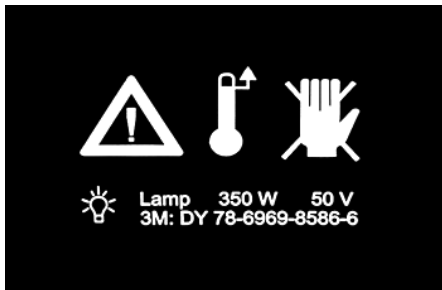

Inside of projector gets very HOT! Allow internal parts to cool before replacing the lamp.

LOCATION OF LABELS

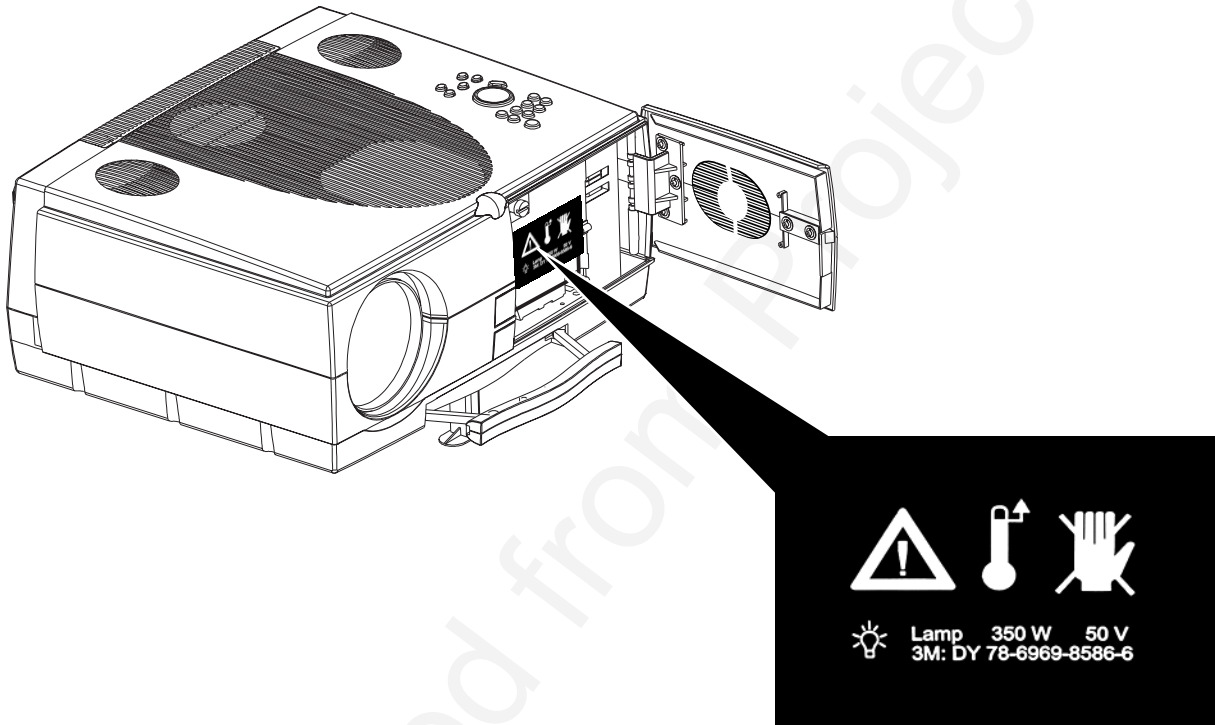

SAVE THESE INSTRUCTIONS

The information contained in this manual will help you operate and maintain your 3M MP8760 Multimedia Projector.

Warranty

LIMITED WARRANTY

3M warrants this product against any defects in material and workmanship, under normal use and storage, for a period of two years from date of purchase. Proof of purchase date will be required with any warranty claim. In the event this product is found to be defective within the warranty period, 3M's only obligation and your exclusive remedy shall be replacement of any defective parts (labor included).

To obtain warranty service, immediately notify the dealer from which you purchased the product of any defects. In the USA call 1-800-328-1371 for warranty or repair service.

Exclusion to Warranty

The projection lamps are considered a consumable item and are warranted for 90 days or 180 hours of operation whichever occurs first.

LIMITATION OF LIABILITY

THE FOREGOING WARRANTY IS MADE IN LIEU OF ALL OTHER WARRANTIES, EXPRESSED OR IMPLIED, AND 3M SPECIFICALLY DISCLAIMS ANY IMPLIED WARRANTY OF MERCHANTABILITY AND FITNESS FOR A PARTICULAR PURPOSE. 3M SHALL NOT BE LIABLE FOR ANY DAMAGES, DIRECT, CONSEQUENTIAL, OR INCIDENTAL, ARISING OUT OF THE USE OR INABILITY TO USE THIS PRODUCT.

Important: The above warranty shall be void if the customer fails to operate product in accordance with 3M's written instructions. This warranty gives you specific legal rights and you may have other rights that vary from state to state.

FCC STATEMENT - CLASS A: This equipment generates, uses and can radiate radio frequency energy, and if not installed and used in accordance with the instruction manual may cause interference to radio communications. It has been tested and found to comply with the limits for a Class "A" computing device pursuant to Subpart B of Part 15 of the FCC Rules, which are designed to provide reasonable protection against such interference when operated in a commercial environment. Operation of this equipment in a residential area is likely to cause interference in which case the user at his/her own expense will be required to take whatever measures may be required to correct the interference.

EEC STATEMENT: This machine was tested against the 89/336/EEC (European Economic Community) for EMC (Electro Magnetic Compatibility) and fulfills these requirements.

Video signal cables: Only use cables delivered by the manufacturer.

Video inputs: The input signal amplitude must not exceed the specified level.

PATENTS, TRADEMARKS & COPYRIGHTS

IBM and **PS/2** are registered trademarks of **International Business Machines Corporation**. **Apple Macintosh** and **ADB** are registered trademarks of **Apple© Computer, Inc.** **Microsoft Windows** is a trademark of the Microsoft Corporation. **DLP™** is a trademark of Texas Instruments Incorporated. All other products are trademarks or registered trademarks of their respective companies.

Section 1: Unpack

1-1. Contents of Shipping Box

The MP8760 is shipped with the necessary cables required for standard VCR, PC or laptop computer connections. Carefully unpack and verify that you have all of the items shown below in Figure 1-1. If any of these items are missing, please contact your place of purchase.

<u>Item</u>	<u>Quantity</u>	<u>Item</u>	<u>Quantity</u>
1. MP8760 Multimedia Projector	1	6. S-VHS video cable (3m)	1
2. IR Remote control transmitter (Two AAA batteries included)	1 2	7. PS/2-Mouse-Adapter	1
3. Power cord set (US, UK, Europe)	1	8. Serial Mouse cable	1
4. VGA cable (2m)	1	9. Operator's Guide, 7 languages(not shown)	1
5. RCA Video/ Audio (3m)	1	10. Registration card	1
		11. Telephone (800#) stickers	2

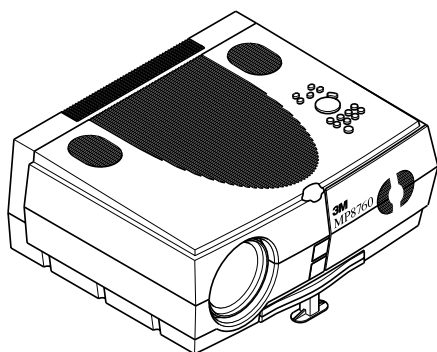

1

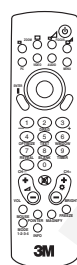

2



3

✓ Note

A set of cables/adapters for connection to Apple Macintosh computers is available as an option.

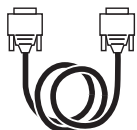

4



5



6



7

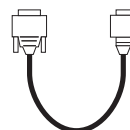

8

Figure 1-1. Packing List

1-2. Keep Your Packing Materials

Save the shipping box and packing materials in the event the MP8760 should require shipping to a 3M Service Center for repair. Use packing material to protect projector.

1-3. What's Next?

Take a few minutes to review Section 2 to familiarize yourself with the MP8760 machine characteristics and then turn to Section 3 to set up the projector.

We hope you will enjoy using this high performance product in your meetings, presentations and training sessions. This product has been produced in accordance with 3M's highest quality and safety standards to ensure smooth and trouble-free use in the years to come.

Section 2: Production Description

2-1. Machine Characteristics

The MP8760 integrates NTP lamp and Digital Light Processor (DLP) technology. It accepts input from computer and/or video sources and projects a super bright image.

The MP8760 Multimedia Projector is easy to set up and use. It offers the following features:

- Extremely light weight and portable
- NTP projection lamp 350W
- VGA (640 x 480) expansion
- SVGA (800 x 600) expansion
- XGA (1024 x 768) native resolution
- SXGA (1280 x 1024) compressed
- NTSC, PAL, SECAM compatible
- Ability to display 16.7 million colors
- Two computer input connections each with a separate audio-in connection
- Built-in Serial, PS/2 and ADB mouse emulation
- Three video/audio input connections
- Power focus, zoom and height shift
- Full function remote control
- Surround sound system
- Horizontal and vertical image inverting function allows rear screen and ceiling mounted projection
- On-screen menu for easy projector set up
- Menu display in English, German, French, Spanish, Italian, Dutch, Swedish
- 0-12 degree adjustable keystone correction

2-2. Parts Identification List

1. Infrared Remote Control Transmitter
2. 3 Speakers (Surround Sound System)
3. Operator Touch Panel
4. Exhaust Fan
5. Terminal Connections
6. Height Adjustment Foot
7. Projection Lens
8. Air intake/air filter
9. Carry Handle
10. Release Button (height adjustment foot)
11. AC Power Connection
12. AC Power Switch
13. Lamp Door
14. Lamp Door Release Button
15. Infrared Sensor

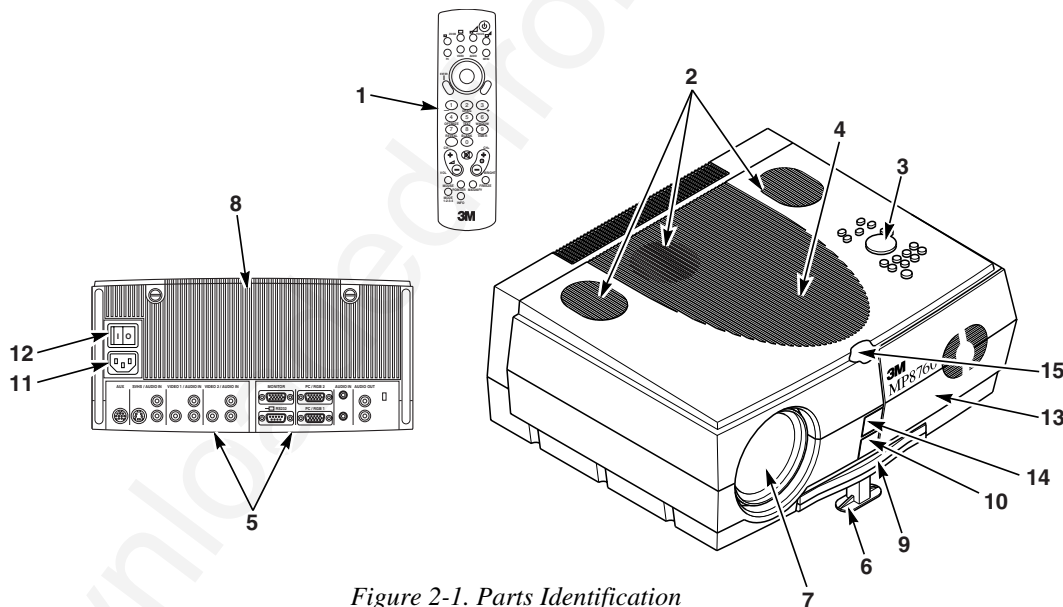

Figure 2-1. Parts Identification

Section 3: Set Up/Connections

3-1. Terminal Connection Panel

The MP8760 projector has terminal connections on the backside of the projector. Refer to Section 3.4-Cable Connections for more detail.

1. **AUX:** Only compatible with 3M devices.
2. **SVHS/AUDIO IN:** SVHS and audio input.
3. **VIDEO1/AUDIO IN:** Video1 and audio input.
4. **VIDEO2/AUDIO IN:** Video2 and audio input.
5. **RS-232C:** Mouse emulation/external projector control.
6. **MONITOR:** Output to external monitor.
7. **PC/RGB1:** Video input #1 from computer.
8. **PC/RGB2:** Video input #2 from computer.
9. **AUDIO IN2:** Audio L/R input from computer #2
10. **AUDIO IN1:** Audio L/R input from computer #1.
11. **AUDIO OUT:** Audio L/R output to external audio system.

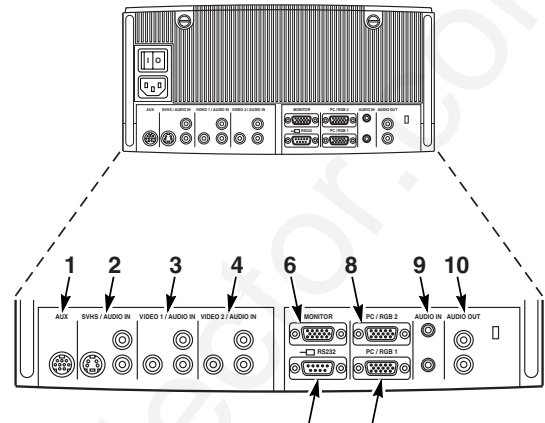

Figure 3-1. Input Connection Terminals

3-2. Operator Touch Panel Keypad

The MP8760 operator touch panel keypad (Figure 3-2) is located on top of the projector. Refer to Section 4 for more detail on using the keypad.

1. **Zoom:** Adjust (decrease/increase) image size.
2. **Video:** Select Video1, Video2 or S-VHS input
3. **PC:** Select PC/RGB 1/2 input.
4. **Enter:** Initiate drop windows, toggle check box (on/off), display Info sub-menu or press and hold then use Disc Pad to reposition menu location.
5. **Volume (-/+):** Adjust (increase/decrease) audio level.
6. **Mute:** Toggle speakers on/off.
7. **Brightness (-/+):** Adjust image brightness. (See Menu.)
8. **Disc/Pad:** Move cursor up/down, left/right.
9. **Menu:** Display/remove menus.
Menu (-/+): Increase/decrease menu value.
10. **Aux:** Toggle On/Off a 3M compatible device.
11. **Focus:** Adjust image focus.
12. **Standby:** Switch between standby mode (lamp off, fan off after cool down) and projection mode (lamp on, fan on).

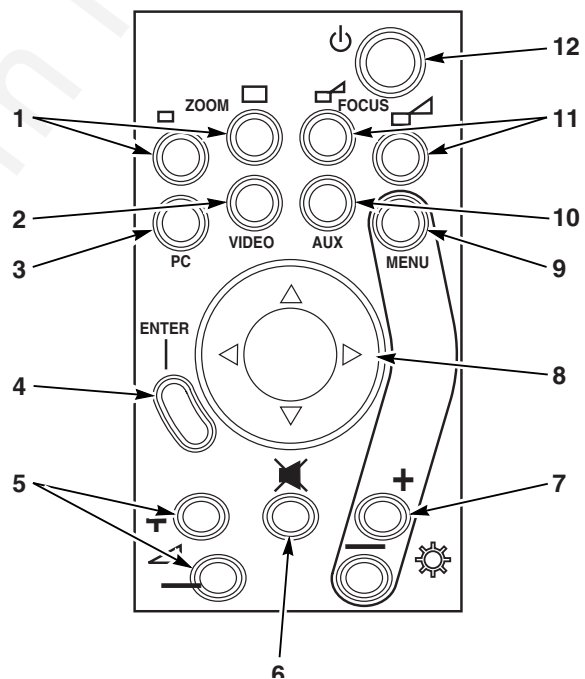

Figure 3-2. Operator Panel Keypad

3-3. Mouse Connection

The MP8760 has mouse emulation capability. Connect your computer mouse to the MP8760 and control computer mouse functions using the remote control.

1. Power down the computer and projector.
2. Remove the mouse cable connection from your computer mouse port.
3. Connect the 9-pin D-Sub plug on the mouse cable to the RS-232 port on the projector.
4. **RS-232 Serial Mouse:** Connect 9-pin D-Sub plug on mouse cable to the serial port on the computer.
PS/2 Mouse: Connect 9-pin D-Sub plug on mouse cable to PS/2 adapter and connect the 6-pin Mini-DIN adapter plug to the PS/2 port on the computer.
MAC ADB: Connect 9-pin D-Sub plug on mouse cable to the Mac ADB adapter and connect the 4-pin Mini-DIN plug on ADB adapter to the ADB port on the computer.
(The Mac ADB adapter is an accessory item that must be ordered separately)

✓ Note

For serial mouse connections to a laptop computer, refer to the manufacturer's operating instructions. The internal pointing device or serial port configurations may need to be changed.

5. First, power on the projector, then power on the computer.

✓ Note

Mouse emulation only works, when all cable connections are established and the proper start up sequence is followed. See section 4-1.

✓ Note

The recommended mouse drivers for mouse emulation is the Standard Microsoft Mouse, Serial or PS/2.

3-4. Cable Connections

1. Turn off all power to the projector and input sources during cable hook up.

 Caution
To prevent damage to equipment , all power to MP8760 and input sources must be turned OFF during cable hook up.

2. Connect cables being careful not to bend any pins in the cable plug or input terminal (Figure 3-1).
3. Start up projector then start up input sources. Section 4-1.

Cable Connection, continued

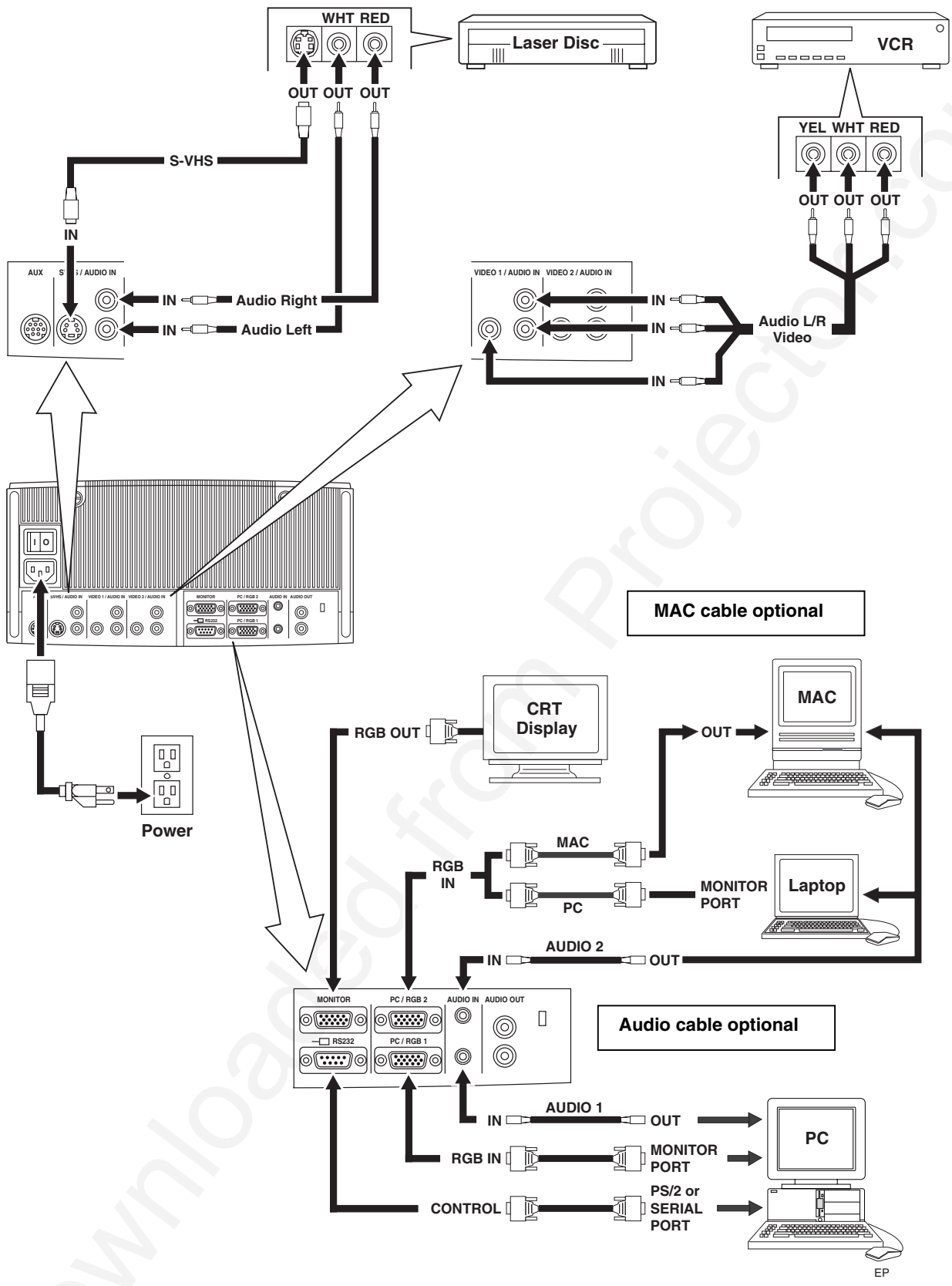

Figure 3-4. Cable Connections

3-5. Image Size (Projector-to-Screen Distance)

Adjust the size of the projected image using the zoom control buttons. The projected image size values, as they relate to the distance-to-screen value, are shown for focal lengths of $f=25\text{mm}$ and $f=45\text{mm}$. Also shown is the maximum image height shift value that can vary depending on the focal length and the distance-to-screen. Figure 3.4.

Distance to Screen m (ft.)	Maximum (f=25mm)			Minimum (f=45mm)		
	Image Width m (in.)	Image Height m (in.)	Max Height m (in.)	Image Width m (in.)	Image Height m (in.)	Max Height m (in.)
2.00 (6.56)	1.42 (56.0)	1.06 (41.7)	0.43 (16.9)	0.80 (31.5)	0.60 (23.6)	0.24 (9.5)
2.50 (8.20)	1.76 (69.3)	1.32 (52.0)	0.54 (21.3)	0.99 (39.0)	0.74 (29.1)	0.30 (11.8)
3.00 (9.84)	2.11 (83.1)	1.57 (61.8)	0.64 (25.2)	1.18 (46.5)	0.89 (35.0)	0.36 (14.2)
5.00 (16.40)	3.48 (137.0)	2.60 (102.4)	1.06 (41.7)	1.96 (77.2)	1.47 (57.9)	0.60 (23.6)
7.00 (22.97)	4.85 (191.0)	3.62 (142.5)	1.47 (57.9)	2.73 (107.5)	2.05 (80.7)	0.83 (32.7)
10.00 (32.81)	6.90 (271.7)	5.16 (203.2)	2.10 (82.7)	3.88 (152.8)	2.92 (115.0)	1.18 (46.5)

Figure 3.4. Image Size/Maximum Image Height

3-6. Image Height

Use the **Picture** menu/**Height** option to shift (upward) the projected image. The center of the projected image can be shifted a maximum of 12 degrees without incurring any keystoneing. Figure 3.5.

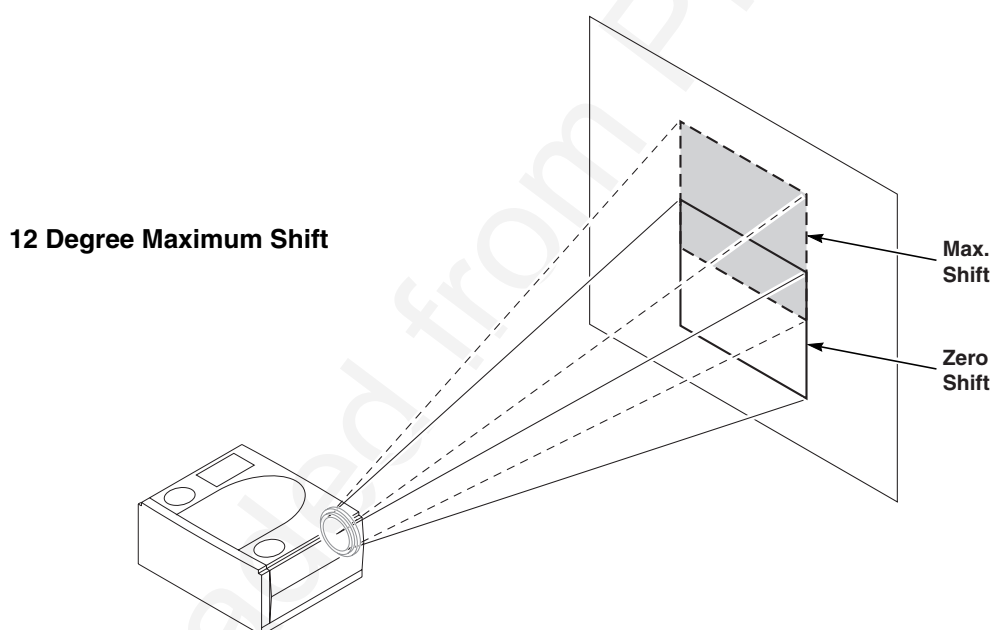

Figure 3.5. Maximum Image Shift

Section 4: Operating Instructions

4-1. Power Up Projector

Read the Important Safeguards before operating the MP8760 projector. After all cable connections have been completed, the projector can be powered up. During operation, keep the exhaust and intake air vents clear of obstructions to allow proper cooling.

⚠ Caution

Allow a projector that has been stored in a cold place to warm up to room temperature before applying power.

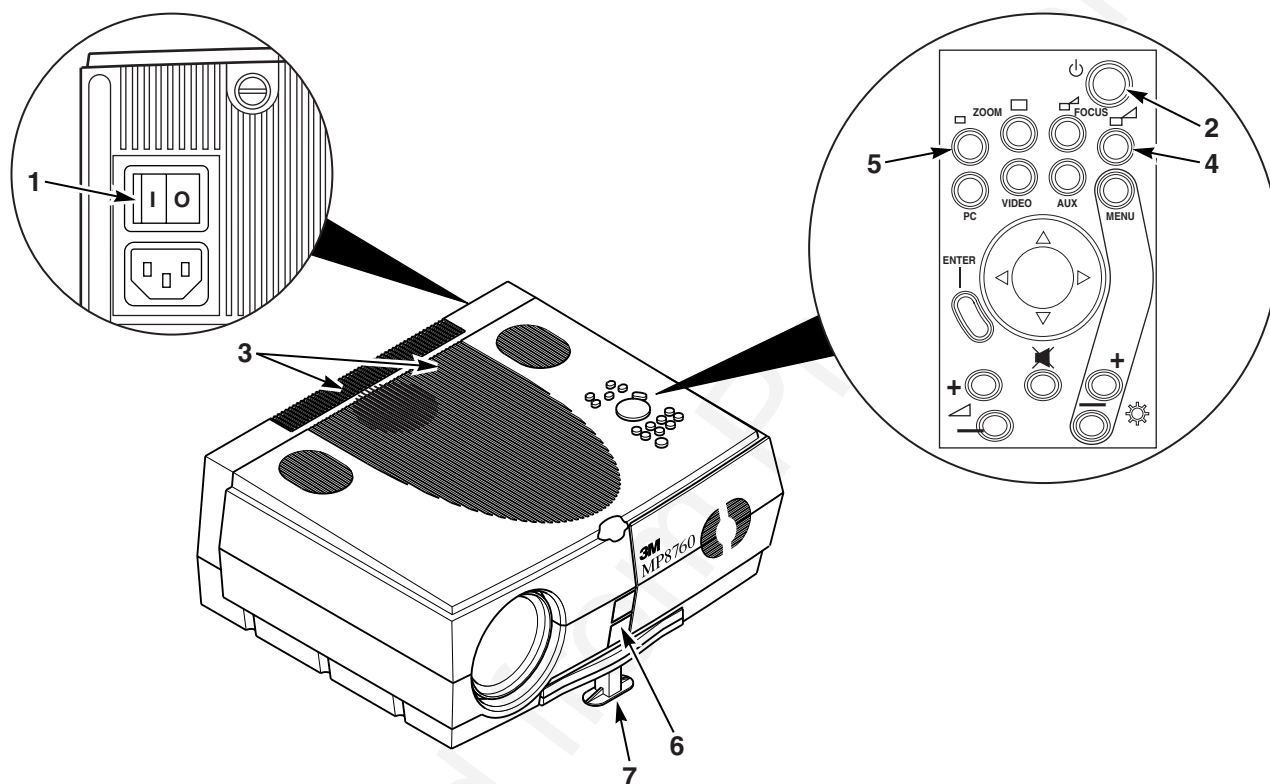

Figure 4-1. Power Up Projector

1. Press the **Main Power** switch **(1)** to ON. A red LED indicator will illuminate to indicate there is power.
2. Press the **Standby** button **(2)** to illuminate the lamp. A red LED indicator will turn green as an image appears and grows brighter on the screen.
3. Check all **ventilation slots (3)** and clear away all obstructions.

✓ Note

Ventilation vents are located on the top and back of the projector. Do not block airflow by placing objects on top of the projector.

4. Adjust the **Focus (4)** and **Zoom (5)** for best image.
5. Press the **Foot Release** button **(6)** to release the **height adjustment foot (7)**.
6. Power up your computer and video source(s).

✓ Note

In most cases, the projector will automatically adjust to the graphic mode of your computer by selecting a pre-programmed setting.

4-2. Standby Mode

When the projector is not being used, place it into standby mode.

1. Press the **Standby** button.
2. The lamp will switch off and the red LED will illuminate.

✓ Note

The fan motor will continue to run for a few minutes until the projector cools down and then the fan will turn off.

3. Press the Standby button again to illuminate the lamp and project an image on the screen.

4-3. Projector Power Down

1. Press the **Standby** button to place the projector in the standby mode (red LED illuminates).
2. Wait until the cooling fan motor cycles off and the lamp LED turns off.

✓ Note

Switching the main power off before the fan has cycled off will decrease the life of the projection lamp.

3. Press the **Main Power** switch to Off.
4. Turn off the power to your input devices.
5. Install lens cap to protect projection lens.
6. To transport the projector, disconnect all power and connection cables.

4-4. Using System Menus

Main Menu: Press the **Menu** button on the operator touch panel keypad (Figure 3-3) or the remote control keypad (Figure 5-1) to display the Main Menu.

Main Menu	1
Picture ▶	2
Audio ▶	
Tools ▶	
Signal source PC/RGB1	3
User Interface ▶	
Advanced Setup ▶	
Info	

The *menu name* (1) is on the top line.

An *arrowhead* (2) at the right of a menu line indicates that this item is a *sub-menu* that can be selected.

A *text field* (3) at the right of a line indicates that this is a value that you can change in a drop down window.

Info: Press **Enter** to display the Info window.

To select a sub-menu, press the **Disc Pad** up or down to highlight (select) the desired sub-menu (2). Then press the **Disc Pad** to the right or the **Enter** button to display the sub-menu (see Sub-Menu).

To change a text field value, press the **Disc Pad** up or down to **highlight** (select) the menu line (3). Then press the **Disc Pad** to the right or the **Enter** button to display a drop down window of all the possible values. Use the **Disc Pad** to select a value and press **Enter** to initiate the selection.

To exit a sub-menu, press the Disc Pad to the left.

To completely exit the menu system and return to the projected image, press the **Menu** button.

Sub-Menu: Select the desired sub-menu (see Main Menu). Press the **Disc Pad** to the right or the **Enter** button to display the sub-menu.

Tools		1
Freeze	<input type="checkbox"/>	2
Magnify	<input type="checkbox"/>	
Factor		3
Timer	off	
Minutes	10	4

The **sub-menu name** (1) is on the top line.

A **checkbox field** (2) at the right of a sub-menu line indicates that you can toggle that value On/Off by pressing the **Enter** button.

A **slider bar** (3) at the right of a sub-menu line indicates you can increase or decrease the value.

A **number field** (4) at the right of a sub-menu line indicates that you can change it.

To change a slider bar value, it must be highlighted. Press the +/- button on the remote control or **Bright +/-** button on the operator touch panel to increase or decrease the value.

To change a number field, press the **Disc Pad** up or down to highlight (select) the menu line. Then press the +/- button on the remote control or **Bright +/-** button on the operator touch panel to increase or decrease the amount of the value.

4-5. Menu Adjustments/Settings

The following charts lists all the menu items that can be adjusted along with the default settings.

Main Menu	Description / Action	Default Setting
Picture	Display picture submenu	
Audio	Display audio submenu	
Tools	Display tools submenu	
Source (drop down window)	Select input source (PC/RGB1 / PC/RGB2 / SVHS / VIDEO 1 / VIDEO 2 / AUX)	According to search procedure
User Interface	Display user interface submenu	
Advanced Setup	Display advanced setup submenu	
Info	Display information window (press Enter)	

Main Menu	
Picture	▶
Audio	▶
Tools	▶
Signal source	PC/RGB1
User Interface	▶
Advanced Setup	▶
Info	





In active PC/RGB mode:



Picture (PC/RGB) Submenu Items	Description / Action	Default Setting
Height	Adjust projected image height	
Brightness	Adjust the brightness	
Contrast	Adjust the contrast	
Optimize	Set best brightness for image	
Hor. Position	Adjust horizontal position of image	
Ver. Position	Adjust vertical position of image	
Tracking	Adjust number of pixels per line	
Sync	Adjust phase synchronization	
Mode	Select data mode to adjust within this menu (Predefined modes / User Mode 1...3)	<Automatic>
Resolution (drop down window)	Select pixel resolution (640x350 / 720x350 / 640x400 / 720x400 / 640x480 / 800x600 / 832x624 / 1024x768 / 1152x864 / 1152x870 / 1152x900 / 1280x960 / 1280x1024)	





Picture	
Height	
Brightness	
Contrast	
Optimize	
Hor. Position	
Ver. Position	
Tracking	1312
Sync	
Mode VESA	1024 x 768 75Hz
Resolution	1024 x 768



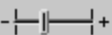

4-5. Menu Adjustments/Settings, continued

In active Video mode:

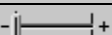
Picture (Video) Submenu Items	Description / Action	Default Setting
Height	Adjust projected image height 	
Brightness	Adjust the brightness	
Contrast	Adjust the contrast	
Color	Adjust color saturation	
Tint	Adjust HUE for NTSC	

Picture	
Height	
Brightness	
Contrast	
Color	
Tint	

Audio Submenu Items	Description / Action	Default Setting
Volume	Adjust volume	
Audio	Audio mute <input checked="" type="checkbox"/> -on / <input type="checkbox"/> -off	<input checked="" type="checkbox"/> -on
Speaker	Speakers <input checked="" type="checkbox"/> -on / <input type="checkbox"/> -off	<input checked="" type="checkbox"/> -on
Balance	Adjust balance	
Treble	Adjust treble	
Bass	Adjust bass	
Surround	Adjust surround sound level	

Audio	
Volume	
Audio	<input checked="" type="checkbox"/>
Speaker	<input checked="" type="checkbox"/>
Balance	
Treble	
Bass	
Surround	

Tools Submenu Items	Description / Action	Default Setting
Freeze	Freeze frame <input checked="" type="checkbox"/> -on / <input type="checkbox"/> -off	<input type="checkbox"/> -off
Magnify	Magnify mode <input checked="" type="checkbox"/> -on / <input type="checkbox"/> -off	<input type="checkbox"/> -off
Factor	Adjust magnification factor	
Timer	Select timer mode (off / small / large)	off
Minutes	Adjust timer countdown (1 to 90 minutes)	10 minutes

Tools	
Freeze	<input type="checkbox"/>
Magnify	<input type="checkbox"/>
Factor	
Timer	off
Minutes	10

User Interface Submenu Items	Description / Action	Default Setting
Language (drop down window)	Select user interface language (English / Deutsch / Français / Español / Italiano / Nederlands / Svenska)	English
Blank Screen Color (drop down window)	Select color of Blank Screen (Black / Red / Green / Blue / Yellow / Cyan / Magenta / White)	Black
Graphics	Activate on-screen status bar indicators and icons. (e.g. ) <input checked="" type="checkbox"/> -on / <input type="checkbox"/> -off	<input checked="" type="checkbox"/> -on
Reset Window Position	Reset all menu window position to default	
Help (drop down window)	Select Help window mode (immediate / 1, 3, or 5 seconds / off)	3 seconds

User Interface	
Language	English
Blank Screen Color	Black
Graphics	<input checked="" type="checkbox"/>
Reset Window Position	
Help	3 seconds

4-5. Menu Adjustments/Settings, continued

In active PC/RGB mode:

Advanced Setup (PC/RGB) Submenu Items	Description / Action	Default Setting
Projection (drop down window)	Select projection orientation (standard / Rear / Rear/Ceiling / Ceiling)	standard
Color Manager	Display Color Manager submenu	
Remote Control	Remote control receiver <input checked="" type="radio"/> -on / <input type="radio"/> -off	<input checked="" type="radio"/> -on
RC Address	Select remote control address (1 / 2 / 3 / 4)	1
Sync Mode1 (drop down window)	Select Sync Mode for PC/RGB1 (separate TTL / composite TTL / separate ana. / composite ana. / sync on green)	separate TTL
Sync Mode2 (drop down window)	Select Sync Mode for PC/RGB2 (separate TTL / composite TTL / separate ana. / composite ana. / sync on green)	separate TTL
SOG Level	Adjust level for sync on green synchronization	
Reset Data Modes	Set all data modes to factory default settings.	
Reset lamp display	Resets the lamp hours displayed on the Info window	
Test	Display test submenu	

Advanced Setup	
Projection	standard
Color Manager	
Remote Control	<input checked="" type="radio"/>
RC Address	1
Sync Mode1	separate TTL
Sync Mode2	separate TTL
SOG level	
Reset Data Modes	
Reset lamp display	
Test	

In active Video mode:

Advanced Setup (Video) Submenu Items	Description / Action	Default Setting
Projection (drop down window)	Select projection orientation (standard / Rear / Rear/Ceiling / Ceiling)	standard
Color Manager	Display Color Manager submenu	
Remote Control	Remote control receiver <input checked="" type="radio"/> -on / <input type="radio"/> -off	<input checked="" type="radio"/> -on
RC Address	Select remote control address (1 / 2 / 3 / 4)	1
Video standard (drop down window)	Select Video standard (PAL B,G,H,I / NTSC M / SECAM / NTSC 44 / PAL M / PAL N / PAL 60 / NTSC COMB / automatic)	automatic
Reset lamp display	Resets the lamp hours displayed on the info window	
Test	Display test submenu	

Advanced Setup	
Projection	standard
Color Manager	
Remote Control	<input checked="" type="radio"/>
RC Address	1
Video standard	automatic
Reset lamp display	
Test	

4-5. Menu Adjustments/Settings, continued

Color Manager Submenu Items	Description / Action	Default Setting
Brightness red	Adjust brightness for red portion	
Contrast red	Adjust contrast for red portion	
Brightness green	Adjust brightness for green portion	
Contrast green	Adjust contrast for green portion	
Brightness blue	Adjust brightness for blue portion	
Contrast blue	Adjust contrast for blue portion	
Default	Sets color settings to default values	

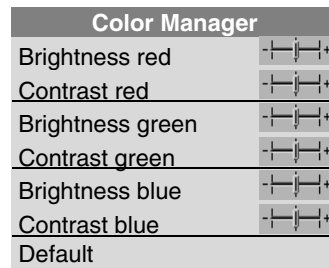

Test Submenu Items	Description / Action	Default Setting
Parameter display	Parameter display window <input checked="" type="checkbox"/> -on / <input type="checkbox"/> -off	<input type="checkbox"/> -off
Color test picture	Display color test picture	
Frame test picture	Display frame test picture	

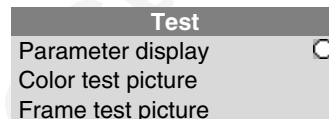

Info (display only)	Description / Action	
Hardware	Current hardware level	
Firmware	Current firmware level	
VESA xxxxxxxxxx	Current data or video mode	
Lamp (bar indicator)	Lamp life hours (Green: lamp good / red: lamp needs replacement)	
OK!	Closes the Info display by pressing the Enter button	

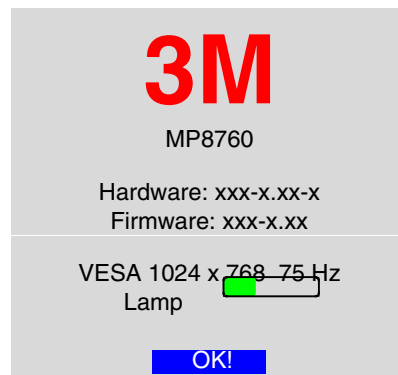

Section 5: Remote Control

5-1. Remote Control Functions

Aim the remote control toward the projection screen or at the sensor. Press desired remote button to send a signal to the projector.

***Video:** Switch displayed image to video input. In Video mode, toggles between: Video1 / Video2 / SVHS

***Zoom:** Increase (+) or decrease (-) size of displayed image.

***Standby:** Switch the projector between Standby mode (lamp off, fan off) and operation mode (lamp on fan on)

***PC:** Switch to PC mode. In PC mode, toggles between RGB1 & RGB2.

***Focus:** Adjust focus (+/-) of displayed image.

***Enter:** Mouse emulation ON, left mouse button. Mouse emulation OFF, Enter button for confirmation of a selection.

Aux: Toggle On/Off a 3M compatible device.

Drag: Lock left mouse button.

***Menu:** Display system menus.

Text: Not used.

Disc Pad (mouse pointer): Move (point) the cursor on the projected image. Navigate menus. See Pointer.

Blank: Replace projected image with white background. Press again to return image.

Menu window position:
In mouse emulation mode: right mouse Button (R).
Not in mouse emulation mode: keep button pressed while moving menu window with **Disc Pad** around

Optimize: Adjust brightness and contrast for best picture.

Reveal: Press Reveal to cover the image on the screen with a gray mask. Use the **Disc Pad** to reveal the image. Press Reveal again to return full screen projection of image.

Window: Toggle between full screen and centered display mode (Non-XGA modes only!!!)

***Volume:** Increase (+) or decrease (-) speaker volume.

Timer: Displays timer (window in lower part of screen). Repeated operation of key toggles on/off.

Mouse: Toggle mouse emulation On/Off.
On: The L & R buttons operate left & right mouse key functions. Drag-and-drop functions are possible by pressing the **Drag** button.

***Mute:** Toggle On/Off the audio sound.

Disc Pad moves Mouse pointer.
Off: L button is the Enter confirmation button. R button is for menu window. Disc Pad centers image positioning. **Disc Pad** centers image.

***Bright:** Increase (+) or decrease (-) brightness of displayed image.

Mode 1,2,3,4: Toggle between remote control addresses 1, 2, 3, 4. (See Appendix ?)

Freeze: Stores (freezes) the projected image. Press again to return the projection of the current image.

Info: Display information window.

Magnify: Press to enable magnification mode. Press +/- buttons to increase/decrease the magnification factor. Move **Disc Pad** to displace the magnified area within the image. Press Magnify again to toggle back to normal presentation.
In video mode (NTSC only), press Magnify to toggle between scaled and unscaled representation.

Pointer: Place a pointing device on the screen. Use **Disc Pad** to move pointer.

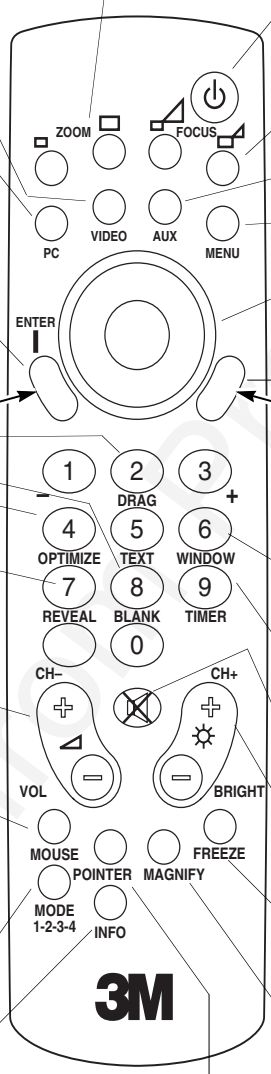

An icon will display to indicate a presentation tool is active.

Pointer	Freeze image	Mouse	Mute	Magnify image	Reveal image

✓ Note
 The buttons marked with an asterisk (*) also appear on the operator touch panel keypad.

5-2. Meaning Of The Icons

An icon will display to indicate a presentation tool is active.



Pointer mode

Activate with **Pointer** button on IR-Remote control

In the Pointer mode you can move a pointer over and around the picture area.
By pressing the **Pointer** button on the remote control a second time it will be turned off.



Freeze mode

Activate with **Freeze** button on IR-Remote control

In the Freeze mode the picture will be frozen.
Pressing the **Freeze** button on the remote control a second time or the **Magnify** button, the freeze mode will be turned off.



Magnify mode

Activate with **Magnify** button on IR-Remote control

In the magnify mode the image can be magnified (zoomed). With the **-(1)** and **+(3)** buttons you can decrease or increase the magnifying factor. You can select the magnified area by using the **Disc Pad**.
Pressing the **Magnify** button on the remote control a second time, the magnify mode will be turned off.



Reveal mode

Activate with **Reveal (7)** button on IR-Remote control

In the reveal mode the picture will be covered by a grey sheet. You now can reveal the covered image by using **Disc Pad**. Pressing the **Reveal** button on the remote control a second time, the reveal mode will be turned off.



Muting mode

Activate with **Mute** button on IR-Remote control

In the muting mode the sound output of the projectors internal speakers and the external output will be muted.
Pressing the **Mute** button on the remote control a second time, the muting mode will be turned off.



Mouse emulation (Only in data mode [PC/RGB_] available!)

Activate with **Mouse** button on IR-Remote control

If you've connected the projector with the mouse cable and the right adapters to your PC and turned on the projector before booting the PC it will emulate a mouse over the IR remote control transmitter.
By pressing the **Mouse** button on the IR remote control the mouse emulation will be activated. You can move around the mouse pointer with the **Disc Pad**. The **Disc Pad** is pressure sensitive, that means so stronger you press the pad so faster the mouse pointer will move. The mouse buttons will be emulated by the two buttons **left** and **right** beside the **Discpad**. The drag function can be emulated by the **Drag (2)** button below the **Disc Pad**. The mouse emulation can be turned off by pressing the **Mouse** button a second time.

5-2. Meaning Of The Icons, continued



Question mark

A question mark in a box will appear if the projector can't recognize the mode of the data input source.

Even if you select a standard VESA mode on your system this can happen, because some device drivers of the graphic cards in the PC using timing parameters which differ from the parameters given out from the VESA organization.

As a result of this, the projector may detect a wrong predefined data mode or switches to a User mode, so you may see only a part of the whole picture.

To correct this situation you must select manually a data Mode in the Picture menu which should match the mode you've selected on the PC. If there is no matching mode you must select a User mode.

In a User mode you can manually select the Resolution which is normally not choosable.

It may be necessary to correct the **Horizontal** and **Vertical Position** and the **Tracking** and **Sync** values in the Picture menu. These values will be stored so the mode can be recognized the next time.

If you've accidentally misadjusted the values of a standard predefined data mode, you can reset them by selecting Reset Data Modes in the **Advanced Setup** menu. The settings of a User mode won't be affected by this action.

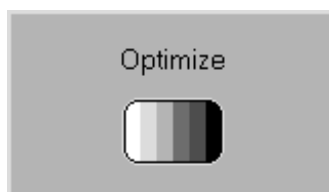

Optimize

The image optimize process is just in progress – please wait a few seconds!



Looking for signal source...

The projector can not find any input signal on the video and data inputs.

Either there is no input source connected to the projector or the source is giving no output signal.

For RGB/PC input sources you must manually select another **Sync Mode** recognition in the **Advanced Setup** menu.

5-3. Battery Replacement

The remote control uses two AAA batteries. The battery cover is located on the back of the remote control.

1. Press the **locking tab (1)** to release door. Figure 5-1.
2. Lift up on the door **(2)** to remove it and set it to the side.
3. Remove old batteries.
4. Install new **batteries (3)**. Make sure the polarity (+/-) on each battery matches the decal.
5. Replace battery compartment door.

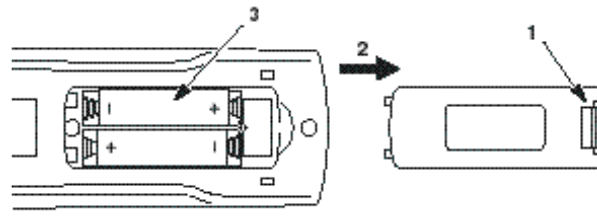

Figure 5-1. Replacing Batteries

Section 6: Maintenance

6-1. Replacing The Air Filter

For best performance, replace the air filter each time the projection lamp is changed.

✓ **Note**

*Periodically check air filter for excess dust or dirt.
Replace or clean as needed.*

1. Unplug the **power cord (1)** of the projector.
2. Unscrew two **screws (2)** securing back panel.
3. Remove the **back panel (3)**.
4. Separate the air filter from the back panel (**4**).
5. Vacuum (**5**) the air filter to remove the dust and dirt.
6. Insert the air filter in the back panel.
7. Insert the back panel and secure with **screws (2)**.

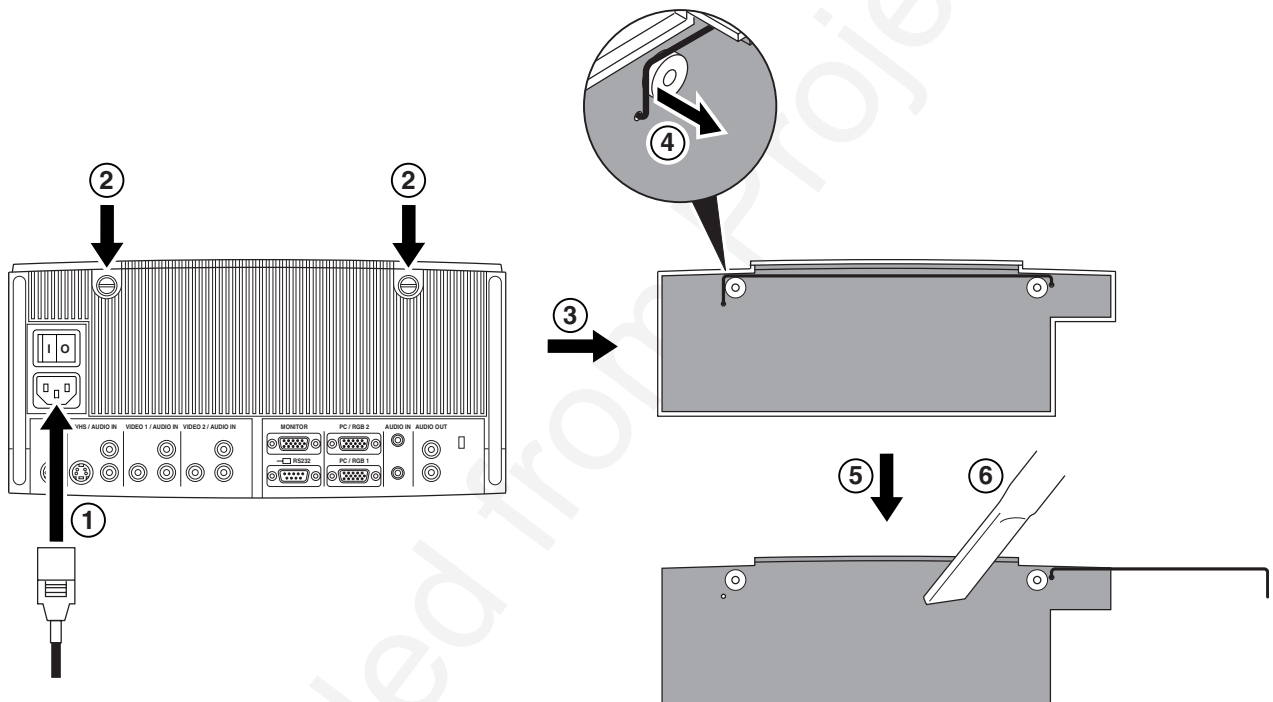

EPS-53A

Figure 6-1. Removing Air Filter Door

6-2. Replacing Projection Lamp

The NTP lamp of the projector has a limited lifetime of approximately 1500 hours. If the projected image appears dark or a *red* lamp life indicator bar displays during projector startup, you should change the lamp and air filter.

✓ Important Note

This lamp contains mercury. Consult your local hazardous waste regulations and **dispose of this lamp in a proper manner.**

⚠ Caution

Always unplug the projector when changing the lamp. There are high voltage parts inside the cabinet that may **cause electric shock.**

⚠ Caution

Allow the projector to cool down for 30 minutes. Lamp and adjacent metal parts become extremely hot and can cause **burns to your fingers.**

1. Press the Standby/On button on the operator touch panel or remote control. Wait for the fan motor to cycle off.
2. Turn the **main power switch** to **OFF** and unplug the projector power cord.
3. Set the projector on a sturdy surface with the front of the projector facing you.
4. Press and hold the **lamp door button (1)** with your index finger. Slide your finger to the right and depress the **lock tab (2)**. Pull outward on the **lamp door (4)** to hinge it to the right side and access the **lamp cartridge (5)**.
5. Unscrew two **retaining screws (3)** securing the **lamp cartridge (5)**.
6. Grasp **handle (6)** and carefully pull the **lamp cartridge (5)** out of the projector.
7. Carefully insert the new **lamp cartridge (5)** and secure with **retaining screws (3)**.
8. Close the **lamp door (4)** tightly until the **lock tab (2)** slides into the locked position.
9. Go to the **Advanced Setup** menu and **reset the lamp life display** to zero. (see 6-3. Lamp Life Indicator)

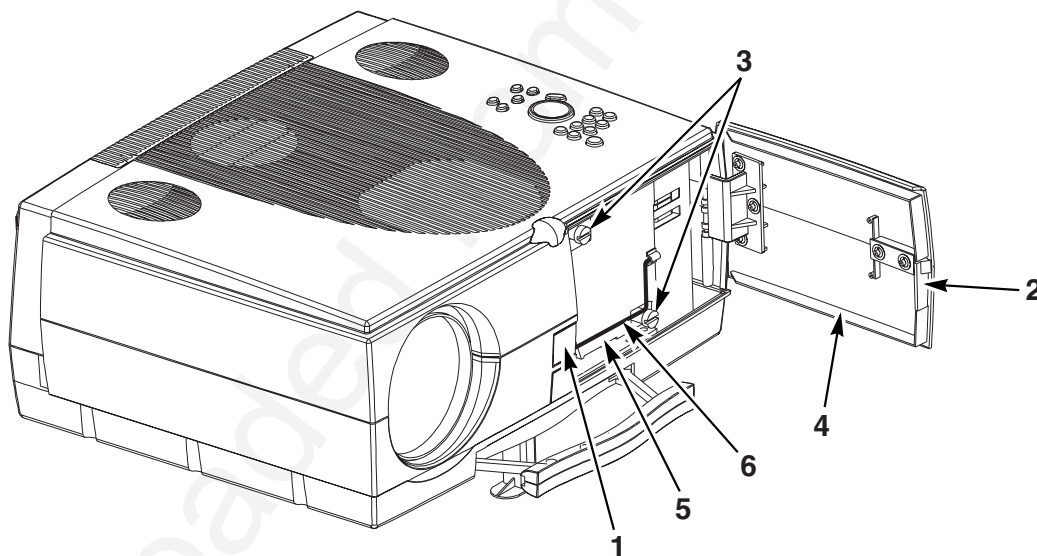

Figure 6-2. Changing the lamp cartridge

6-3. Lamp Life Indicator

The elapsed operating time of the lamp is displayed on the Info sub-menu. From the Main menu, select **INFO** to display the lamp life. As long as the lamp indicator bar is green, the lamp is good. When the bar changes to red, the lamp should be changed.

After changing the projection lamp, the lamp life indicator must be reset to zero.

To reset the lamp life indicator:

1. Press the **Menu** button to display the main menu.
2. Select the *Advanced Setup* sub-menu using the **Disc Pad**.
3. Select *Reset lamp display* and press the **Enter** button.
4. The following message will display: “**Really reset lamp life display? OK! / Cancel**”
5. Using the **Disc Pad**, select **OK!** and press **Enter** to acknowledge the change.
6. Press **Menu** to exit the menu system.

✓ Note

To view the used/remaining lamp life:

- (1) Go to the Main Menu.
- (2) Select “**Info**”.
- (3) Press the **Enter** button.

6-4. Cleaning the Projector

For best performance, keep your projector free of excess dust and surface dirt. Use a soft cloth to remove dust from the projector housing. Use 3M™ High Performance Cleaning Cloth to remove surface dirt and smudges from the projection lens.

⚠ Caution

Always unplug the projector when cleaning. Take care that no liquids get inside the projector. There are high voltage parts inside the cabinet that may **cause electric shock**.



Figure 6-3. High Performance Cleaning Cloth

Section 7: Troubleshooting

7-1. Troubleshooting Problems and Solutions

Problem	Probable Cause	Possible Solution
Projector will not turn on.	<ul style="list-style-type: none"> Power cable is disconnected or not plugged in. Main power switch is not on. The ?inner fuses? are open? 	<ul style="list-style-type: none"> Plug the power cable into an AC outlet. Turn the main power switch to the ON position. Send the unit to be repaired.
Image is disturbed or unstable.	<ul style="list-style-type: none"> Wrong Sync setting. Wrong Tracking value. 	<ul style="list-style-type: none"> Set to factory default setting. (See below!) Change Sync setting in the Picture menu for optimum performance For vertical interference stripes, change the Tracking in the Picture menu for optimum performance.
No computer image projected. Message “ Looking for signal ... ” displays.	<ul style="list-style-type: none"> Loose cable. No power to computer. Wrong synchronization mode. 	<ul style="list-style-type: none"> Check and secure cable connections. Turn on computer. Adjust synchronization mode of the projector to the synchronization mode of the computer via Advanced Setup menu.
No video image projected.	<ul style="list-style-type: none"> Loose cable. No signal from video source. 	<ul style="list-style-type: none"> Check and secure cable connections. Check video picture on TV.
No video images are projected or the video image ?does something? and turns off.	<ul style="list-style-type: none"> The video source is sending a video signal and the projector cannot automatically select the video standard in use. 	<ul style="list-style-type: none"> In the submenu Video Standard? in the Advanced Setup menu, manually change the video standard from Automatic to the type of standard in use.
Mouse does not work.	<ul style="list-style-type: none"> Loose cable. Wrong connection. Wrong power up sequence. 	<ul style="list-style-type: none"> Check and secure cable connections. For PS/2 and ADB (Apple) mouse a special adapter is necessary. Only use adapters from the original manufacturer (Section 8-2). The mouse emulation operates correctly only if the correct power up sequence has been used (refer to section 3-5.) To verify that the projector is programmed for the desired mouse emulation mode, go to the Screen Parameters? In the Advanced Setup/Test submenu. Check that the parameter MTPE presents the desired mouse mode. This is not a selection, but a ???? that shows the type of mouse emulation with which the projector is programmed to communicate.
The lamp turns off, the Standby button and LED lights up and stays green as the fan cools the unit, and the unit goes into Standby Mode.	<ul style="list-style-type: none"> The air intake or exhaust vents are blocked. The air filter is dirty. 	<ul style="list-style-type: none"> Clear all obstructions from the air intake and exhaust vents. Clean or replace the filter.
The lamp turns off, the unit goes into Standby Mode, and the fan ????s more rapidly.	<ul style="list-style-type: none"> The air intake or exhaust vents are blocked. The air filter is dirty. 	<ul style="list-style-type: none"> Clear all obstructions from the air intake and exhaust vents. Clean or replace the filter.
The lamp turns off, the Standby button blinks red for a few seconds, and the unit goes into Standby Mode.	<ul style="list-style-type: none"> The air intake or exhaust vents are blocked. The air filter is dirty. 	<ul style="list-style-type: none"> Clear all obstructions from the air intake and exhaust vents. Clean or replace the filter.

Note: It is necessary to turn the projector off and on with the main power switch before restarting the projector.

The Standby button blinks red and the lamp with not turn on.	<ul style="list-style-type: none"> There is no lamp in the unit. The lamp is improperly placed in the unit. 	<ul style="list-style-type: none"> Put a 3M MP8760 lamp in the unit. Install the lamp again.
A question mark appears in the lower left of the screen when connecting to computer video.	<ul style="list-style-type: none"> The horizontal and vertical synchronization signals from the computer video are not correctly polarized according to VESA video standards. The computer video signal is not a VESA or Mac standard. 	<ul style="list-style-type: none"> Select Mode in the Image menu, select the correct video mode, and press Enter.
Image off-center.	<ul style="list-style-type: none"> Image position. 	<ul style="list-style-type: none"> Center image with the Disc Pad of the control panel or on the remote control transmitter.
Cannot get entire image on the screen.	<ul style="list-style-type: none"> Wrong Tracking value. Compatibility problem. 	<ul style="list-style-type: none"> If vertical interference stripes occur, change the Tracking value in the Picture menu for optimum performance. Refer to the documentation for your graphic card. Change the Resolution setting in the Picture menu to the resolution of the video mode output from the computer graphic card.
Washed out image.	<ul style="list-style-type: none"> Wrong Contrast setting. Wrong Brightness setting. 	<ul style="list-style-type: none"> Change Contrast setting in the Picture menu. The bar should be in the middle position. Lower Brightness setting in the Picture menu. Choosing Brightness and pressing Enter can perform an automatic adjustment.
Humming noise. Slowly passing horizontal bars.	<ul style="list-style-type: none"> Signal sources are connected to different power sources. VCR connected to aerial system and to projector. Bad signal. 	<ul style="list-style-type: none"> Locate the source of disturbance. Disconnect the sources one after another from the projector. Connect all sources to a common power source. Remove antenna connection from VCR. If the disturbance disappears, use a by-pass filter (isolating transformer) to connect the antenna to the VCR. Try different input source.
Image is disturbed or unstable.	<ul style="list-style-type: none"> Wrong Sync setting. Wrong Tracking value. 	<ul style="list-style-type: none"> Set to factory default setting. (See below!) Change Sync setting in the Picture menu for optimum performance For vertical interference stripes, change the Tracking in the Picture menu for optimum performance.
No computer image projected. Message "Looking for signal ..." displays.	<ul style="list-style-type: none"> Loose cable. No power to computer. Wrong synchronization mode. 	<ul style="list-style-type: none"> Check and secure cable connections. Turn on computer. Adjust synchronization mode of the projector to the synchronization mode of the computer via Advanced Setup menu.
No video image projected.	<ul style="list-style-type: none"> Loose cable. No signal from video source. 	<ul style="list-style-type: none"> Check and secure cable connections. Check video picture on TV.
Mouse does not work.	<ul style="list-style-type: none"> Loose cable. Wrong connection. Wrong power up sequence. 	<ul style="list-style-type: none"> Check and secure cable connections. For PS/2 and ADB (Apple) mouse a special adapter is necessary. Only use adapters from the original manufacturer (Section 8-2). The mouse emulation operates correctly only if the correct power up sequence has been used (refer to section 3-5.)
Image off-center.	<ul style="list-style-type: none"> Image position. 	<ul style="list-style-type: none"> Center image with the Disc Pad of the control panel or on the remote control transmitter.
Cannot get entire image on the screen.	<ul style="list-style-type: none"> Wrong Tracking value. Compatibility problem. 	<ul style="list-style-type: none"> If vertical interference stripes occur, change the Tracking value in the Picture menu for optimum performance. Refer to the documentation for your graphic card. Change the Resolution setting in the Picture menu to the resolution of the video mode output from the computer graphic card.
Washed out image.	<ul style="list-style-type: none"> Wrong Contrast setting. Wrong Brightness setting. 	<ul style="list-style-type: none"> Change Contrast setting in the Picture menu. The bar should be in the middle position. Lower Brightness setting in the Picture menu. Choosing Brightness and pressing Enter can perform an automatic adjustment.

Humming noise. Slowly passing horizontal bars.	<ul style="list-style-type: none"> • Signal sources are connected to different power sources. • VCR connected to aerial system and to projector. • Bad signal. 	<ul style="list-style-type: none"> • Locate the source of disturbance. Disconnect the sources one after another from the projector. Connect all sources to a common power source. • Remove antenna connection from VCR. If the disturbance disappears, use a by-pass filter (isolating transformer) to connect the antenna to the VCR. • Try different input source.
--	---	---

✓ Note

The factory default settings of the projector can be restored by pressing **Enter** and **Mute** simultaneously on the control panel when switching on the main power switch of the projector and pressing the **Standby** button afterwards.

The projector will start immediately and the message "**Parameter factory settings restored**" displayed in the starting screen will indicate the default settings are reset.

7-2. Service Information

For product information, product assistance, service information, or to order accessories or spare parts, please call:

In U.S. or Canada: **1-800-328-1371**

In other locations, contact your local 3M Sales office.

Section 8: Product Specifications

8-1. Technical Specifications

Display Technology	Single DMD
Resolution	1,024 x 768 (total 2,359,296 pixels) 625 (PAL) / 525 (NTSC) video lines to full screen size magnification
Colors	16,770,000 colors
Zoom / Focus / Height shift	Power control
Projection Lens	Throw Ratio=1.44 – 2.59 / f=25 - 45 mm Power Zoom / Power Focus, 0° - 12° Power Height Shift
Picture Size	1.0 - 8.7 m (38 - 340 in.) diagonal, 2.6 m diagonal at 3.0 m distance and f=25 mm
Projection Lamp	350 W DC NTP lamp
PC Compatibility	Resolution 640 x 400 & 800 x 600 (magnified), 1024 x 768 (native) and 1280 x 1024 (compressed) (sync on green is available)
Video Compatibility	NTSC / NTSC 4.43 / PAL (including PAL-M, N) / SECAM, PAL-60
Input Terminals	PC/RGB: RGB x 2 (D-Sub 15-pin) PC/RGB: PC-Audio x 2 (3.5 mm stereo mini jack) Video: RCA x 2 + SVHS x 1 + Camera/Aux x 1 Video: Audio x 3 (2 x RCA left/right)
Output Terminals	RGB-Monitor: RGB x 1 (D-Sub 15-pin) Audio: Audio x 1 (2 x RCA left/right)
Communication Terminals	RS-232C (D-Sub 9-pin)
Scanning Rates	Hor.: 15-86 kHz, Vert.: 50-160 Hz
Audio Speakers	20 Watts, stereo surround sound
Height Adjuster	Front leg (additional 0°... 9°, variable)
Unique Features	Digital magnification, Wireless infrared remote control
Remote Control Transmitter	Projector control, PC/MAC mouse cursor control
Dimension (WxHxD)	331 x 137 x 272 mm
Power Requirements	AC 100-240 V \pm 50/60 Hz
Power Consumption	450 W
Regulatory Approvals	FCC Part 15, Class A, CE, UL
Warranty	Two years limited warranty on parts and labor

8-2. Accessory & Spare Parts List

Part Description	Part Number
Projection Lamp Kit - NTP Lamp (350W) - Air Filter	78-6969-9048-6
Air Filter (included in lamp kit 78-6969-9048-6)	78-8118-3476-7
Power Cords (U.S., UK, Europe) For special power cords. See Appendix D-3	DY-0205-1356-9 (U.S.) DY-0205-1355-1 (UK) DY-0205-1354-4 (Europe)
VGA Cable (15-15 pin male/male)	DY-0205-1271-0
Video Cable (S-Video Mini-DIN-4pin)	DY-0205-1010-2
Composite Video Cable (RCA to RCA)	DY-0205-1008-6
Audio Cable (RCA to 3.5 mm stereo)	DY-0205-1359-3
PC Serial Cable (PC mouse connection)	DY-0205-1007-8
Remote Control	78-8118-3475-9
Mac Cable Set (optional)	DY-0205-1361-9
Carry Case (optional)	78-6969-8587-4
Shipping Case (optional)	78-6969-8588-2
Mouse Y-Cable (optional)	DY-0205-1507-7
Extension Cable Kit (optional)	XX-0034-1714-2
PC-Audio Cable (3.5 mm stereo to 3.5 mm stereo) (optional)	26-1012-0683-2
Ceiling Mount Kit (optional)	78-6969-8591-6

Mac Cable Set (optional), Part number DY-0205-1361-9: This kit contains a Mac mouse adapter and a Mac video cable.

Extension Cable Kit (optional), Part number XX-0034-1714-2: The extension cable kit includes a video amplifier and 20 m (65 ft.) video cable. The kit increases the allowable distance between the projector and the video source without burdening the video source.

Mouse Y-Cable (optional), Part number DY-0205-1507-7: This cable provides user with the option to simultaneously operate the MP8760 remote mouse and a PC mouse (only works with Microsoft serial mouse).

8-3. How to Order

Please order these parts through your dealer, or contact 3M Customer Service at the following number:

- In U.S. or Canada: **1-800-328-1371**
- In other locations, contact your local 3M Sales office.

Appendix

A-1. Optional Lenses Charts

Note: The zoom function is not available when optional lenses are installed.

Short Throw Lens:

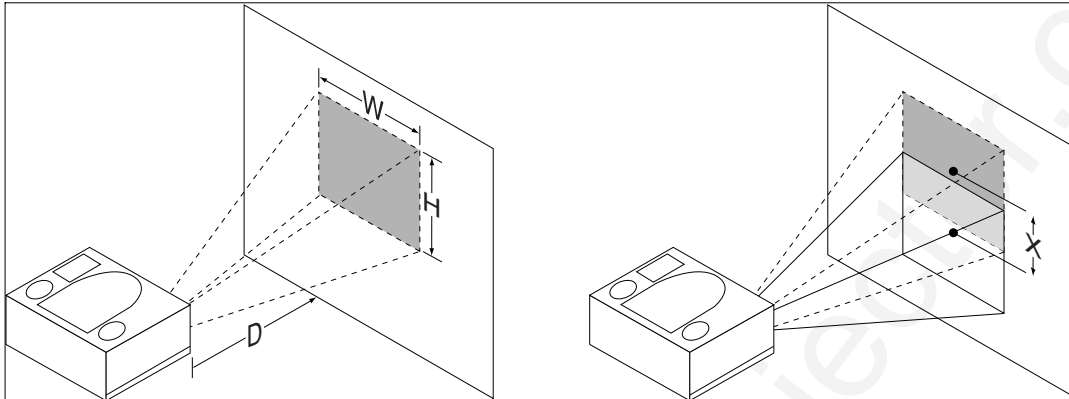

Distance D	f=20 mm					
	Width W		Height H		Shift X	
m (ft.)	m	(in.)	m	(in.)	m	(in.)
1.0 (3.28)	0.93	(36.6)	0.70	(27.6)	0.11	(4.3)
1.5 (4.92)	1.37	(53.9)	1.03	(40.6)	0.16	(6.3)
2.0 (6.56)	1.81	(71.3)	1.36	(53.5)	0.21	(8.3)
3.0 (9.84)	2.69	(105.9)	2.02	(79.5)	0.31	(12.2)
4.0 (13.12)	3.57	(140.6)	2.67	(105.1)	0.41	(16.1)

Long Throw Lens:

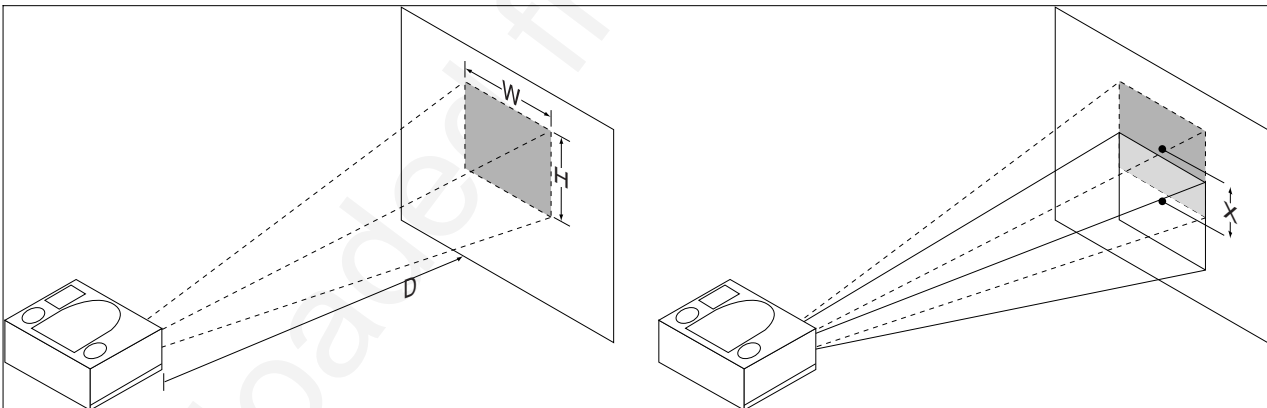

Distance D	f=88 mm					
	Width W		Height H		Shift X	
m (ft.)	m	(in.)	m	(in.)	m	(in.)
4.0 (13.12)	0.80	(31.5)	0.60	(23.6)	0.23	(9.1)
5.0 (16.40)	1.00	(39.4)	0.75	(29.5)	0.29	(11.4)
6.0 (19.69)	1.20	(47.2)	0.90	(35.4)	0.35	(13.8)
7.0 (22.97)	1.40	(55.1)	1.05	(41.3)	0.40	(15.7)
8.0 (26.25)	1.60	(63.0)	1.20	(47.2)	0.46	(18.1)
9.0 (29.53)	1.80	(70.9)	1.35	(53.2)	0.52	(20.5)
10.0 (32.81)	2.00	(78.7)	1.50	(59.1)	0.57	(22.4)

A-2. Power Cord Sets

A standard power cord set (U.S., UK, or European) will be included with each MP8760. If you need a special power cord set, contact your local 3M authorized dealer. The power cords must be in accordance with the regional and corresponding national safety regulations and be properly approved. Examples of these power cords are shown below.

North America
UL Listed CSA Certified
15A 125VAC

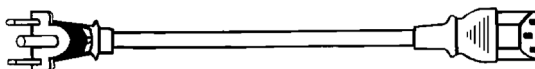

Germany, Netherlands,
Spain, France, Greece
VDE Certified
10A 250VAC

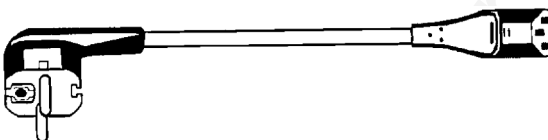

Great Britain
AUSTA Certified
13A 250VAC



Italy
IMQ or BASEC
Certified
10A 250VAC

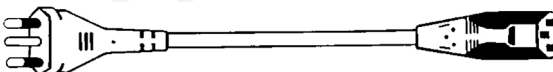

Switzerland
SEV Certified
10A 250VAC

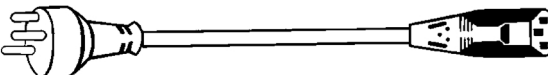

Australian
SAA Certified
10A 250VAC

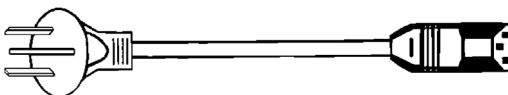

Denmark
Complies with Danish
Standard
6/10A 250VAC

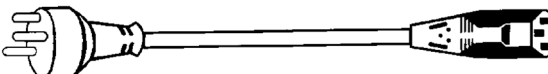

A-3. Changing Of The IR-Remote-Control Address

Changing of the IR-Remote-Control address:

You can choose one out of four different IR-RC addresses for the projector, so you can control four projectors separately without any interferences to another projector.

To change an address from the standard address #1, go to the **Advanced Setup** menu and choose an address of your choice under the menu item **RC Address** (1...4). Confirm your selection with the **Enter** button.

After this point you can't control the projector with the IR-RC transmitter anymore until you change the transmitter address to the same address. (Of course, you still can enter the menu system and change back the address with the **Control Panel** of the projector!)

To change the address of the IR-RC transmitter, please press the **Mode** button and an address number (buttons **1,2,3** or **4**) simultaneously for 4 seconds on the IR-RC transmitter.

After this you should be able to control the projector by IR-RC again if you've chosen the same address for the projector and the IR-RC transmitter.

A-4. Resetting The Projector To Factory Default Settings

The factory default settings of the projector can be restored by pressing **Enter** and **Mute** simultaneously on the control panel when switching on the main power switch of the projector and pressing the **Standby** button afterwards.

The projector will start immediately and the message "**Parameter factory settings restored**" displayed in the starting screen will indicate the default settings are reset.

If you've had selected another menu language as english, which is the default language, you'll have to select your menu language again.

A-5. Supported Data Modes and Resolutions

Table of the predefined Data modes:

Data Mode Name	Resolution Hor. x Vert.	Horizontal Frequency kHz	Vertical Frequency Hz	Pixel- Clock MHz
VGA 640 x 350	640 x 350	30,000	70,000	25
VESA 640 x 350 85Hz	640 x 350	37,861	85,081	32
VGA Text 720 x 350	720 x 350	31,469	70,087	28
VGA 640 x 400	640 x 400	25,560	60,000	25
VESA 640 x 400 85Hz	640 x 400	37,861	85,081	32
VGA Text 720 x 400	720 x 400	31,469	70,087	28
VGA 640 x 480	640 x 480	31,469	59,941	25
VESA 640 x 480 72Hz	640 x 480	37,861	72,810	32
VESA 640 x 480 75Hz	640 x 480	37,500	75,000	32
VESA 640 x 480 85Hz	640 x 480	43,269	85,008	36
VESA 800 x 600 56Hz	800 x 600	35,156	56,250	36
VESA 800 x 600 60Hz	800 x 600	37,879	60,317	40
VESA 800 x 600 72Hz	800 x 600	48,077	72,188	50
VESA 800 x 600 75Hz	800 x 600	46,875	75,000	50
VESA 800 x 600 85Hz	800 x 600	53,674	85,062	56
VESA 1024 x 768 43Hz	1024 x 768	35,522	86,957	45
VESA 1024 x 768 60Hz	1024 x 768	48,363	60,004	65
VESA 1024 x 768 70Hz	1024 x 768	56,476	70,069	75
VESA 1024 x 768 75Hz	1024 x 768	60,023	75,029	79
VESA 1024 x 768 85Hz	1024 x 768	68,677	84,996	95
VESA 1152 x 864 75Hz	1152 x 864	67,500	75,000	108
VESA 1280 x 960 60Hz	1280 x 960	60,000	60,000	108
VESA 1280 x 1024 60Hz	1280 x 1024	63,981	60,020	108
VESA 1280 x 1024 75Hz	1280 x 1024	79,975	75,024	136
Mac 640 x 480	640 x 480	35,000	66,667	30
Mac LC 640 x 480	640 x 480	34,975	66,619	31
Quadra 832 x 624	832 x 624	49,107	75,087	57
Mac 1024 x 768	1024 x 768	60,241	74,927	80
Mac 1152 x 870	1152 x 870	68,681	75,062	100
Mac 1280 x 960	1280 x 960	85,938	85,003	139
Sun 1152 x 900 66Hz	1152 x 900	61,846	66,004	95
Sun 1152 x 900 76Hz	1152 x 900	71,713	76,047	105

Table of predefined Resolutions for User-Mode 1...3:

Predefined Resolutions
640 x 350
720 x 350
640 x 400
720 x 400
640 x 480
800 x 600
832 x 624
1024 x 768
1152 x 864
1152 x 870
1152 x 900
1280 x 960
1280 x 1024

Downloaded from Projector.com

IMPORTANT NOTICE:

All statements, technical information, and recommendations related to 3M's products are based on information believed to be reliable, but the accuracy or completeness is not guaranteed. Before using this product, you must evaluate it and determine if it is suitable for your intended application. You assume all risks and liability associated with such use. Any statements related to the product which are not contained in 3M's current publications, or any contrary statements contained on your purchase order shall have no force or effect unless expressly set forth in a written agreement signed by an authorized officer of 3M.

Warranty and Limited Remedy. This product will be free from defects in material and manufacture for a period of two years from the date of purchase. The projection lamps are considered consumable items and are warranted for 90 days or 180 hours of operation, whichever occurs first. **3M MAKES NO OTHER WARRANTIES, INCLUDING BUT NOT LIMITED TO, ANY IMPLIED WARRANTY OF MERCHANTABILITY OR FITNESS FOR A PARTICULAR PURPOSE.** If this product is defective within the warranty period stated above, your exclusive remedy shall be, at 3M's option, to replace or repair the 3M product or refund the purchase price of the 3M product.

Limitation of Liability. Except where prohibited by law, 3M will not be liable for any loss or damage arising from this 3M product, whether direct, indirect, special, incidental or consequential regardless of the legal theory asserted.

Let us help you make the most of your next presentation. We offer everything from presentation supplies to tips for better meetings. And we're the only transparency manufacturer that offers a recycling program for your used transparencies. For late-breaking news, handy reference and free product samples, call us toll-free in the continental United States and Canada, 24 hours a day, or visit our Internet Website.

**800-328-1371****<http://www.3m.com/meetings>
e-mail: meetings@mmm.com**

3M Austin Center
Building A145-5N-01
6801 River Place Blvd.
Austin, TX 78726-9000

3M Canada
P.O. Box 5757
London, Ontario
N6A 4T1

3M Mexico, S.A. de C.V.
Apartado Postal 14-139
Mexico, D.F. 07000
Mexico

3M Europe
Boulevard de l'Oise
95006 Cerge Pontoise Cedex
France

Litho in USA
Copyright ' 2000 3M IPC.
All Rights Reserved
78-6970-9022-9 Rev. A