

myprojectorlamps.com

**The most trusted, dependable name
in projector lamp sales.**



<http://www.myprojectorlamps.com>



<http://www.myprojectorlamps.ca>



<http://www.myprojectorlamps.eu>

The following projector manual has not been modified or altered in any way.



MP7630B/MP7730B Personal Projector

Operator's Guide

MP7630B/MP7730B Projecteur personnel Guide de l'opérateur

MP7630B/MP7730B Personal Projektor - Benutzerhandbuch

MP7630B/MP7730B Guía del Usuario del Proyector Personal

MP7630B/MP7730B Guida dell'operatore per il Proiettore personale

MP7630B/MP7730B Bruksanvisning för Personlig projektor

MP7630B/MP7730B Personal Projector - Gebruiksaanwijzing

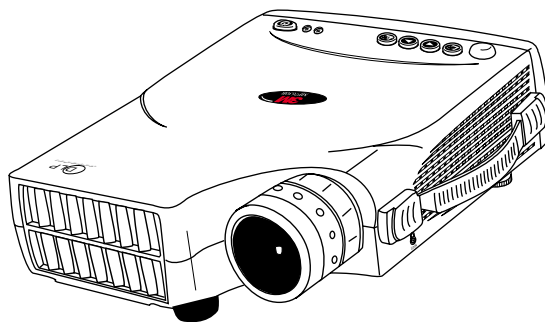

Intended Use Statement

Before operating this machine, please read the Operator's Guide and Product Safety Guide thoroughly. The 3M™ Multimedia Projectors are designed, built, and tested for use indoors, using 3M lamps, 3M ceiling mount hardware, and nominal local voltages. The use of other replacement lamps, outdoor operation, or different voltages have not been tested and could damage the projector peripheral equipment and/or create a potentially unsafe operating condition. 3M Multimedia projectors are designed to operate in a normal office environment.

- 16° to 29°C (60° to 85° F)
- 10-80 % RH (without condensation)
- 0-1828 m (0-6000 feet) above sea level

The ambient operating environment should be free of airborne smoke, grease, oil and other contaminants that can affect the operation or performance of the projector.

Use of this product in adverse conditions will void the product warranty.

Table of Contents

Introduction

Safeguards	4
Thank You for Choosing 3M	6
Warranty	6
Shipping Box Contents	7
Optional Accessories	7
Part Identification	8
Machine Characteristics	9
Remote Control Identification	10
Remote Control Features	11

System Setup

Screen Chart	13
Digital Keystone Correction	13
Connecting to Various Equipment	14
Mouse Connection	15

Operation

Start-up	16
Shutdown	17
Menu System	18
Optional Video Module	23
Attaching the Optional Audio/Visual Module	24
Optional Video Module Menus	25

Maintenance

Lamp Usage	29
Lamp Replacement	30
Resetting Lamp Hours	32

Troubleshooting

Common Problems & Solutions	33
Status Light Messages	34

Service Information

Accessories	35
Ordering Parts or Getting Information	35

**The Appendix is in English only.
Please click here (on the CD-ROM)
to read it.**

Introduction

Intended Use

Before operating the machine, please read the entire manual thoroughly. The 3M Personal Projector MP7630B/MP7730B was designed, built, and tested for use indoors, using 3M lamps, 3M ceiling mount hardware, and nominal local voltages. The use of other replacement lamps, outdoor operation, operation in environments containing heavy cigarette smoke or different voltages has not been tested and could damage the projector or peripheral equipment and/or create a potentially unsafe operating condition.

Important Safeguards

1. Read and understand all instructions before using. Pay particular attention to areas where these symbols are shown:

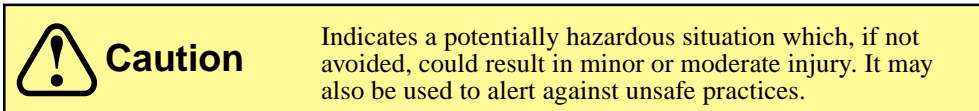

✓ *Note* - Used to emphasize important conditions or details.

2. Close supervision is necessary when any appliance is used by or near children. Do not leave appliance unattended while in use.
3. Never look directly into the projector lens when the lamp is on. The high pressure mercury lamp produces a strong light that could damage your eyesight.
- ⚠ 4. Care must be taken, as burns can occur from touching hot parts.

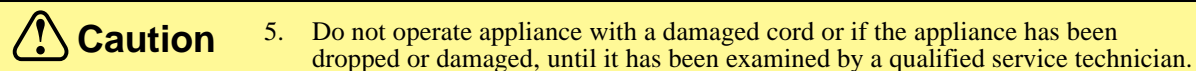

- ⚠ 6. Position the cord so that it will not be tripped over, pulled or placed in contact with hot surfaces.
7. If an extension cord is necessary, a cord with a current rating at least equal to that of the appliance should be used. Cords rated for less amperage than the appliance may overheat.
8. Always unplug appliance from electrical outlet before cleaning and servicing and when not in use. Grasp plug and pull to disconnect.
9. To reduce the risk of electric shock, do not immerse this appliance in water or other liquids.
10. To reduce the risk of electric shock, do not disassemble this appliance. Take it to a qualified technician when service or repair work is required. Incorrect reassembly can cause electric shock when the appliance is subsequently used.
11. Connect this appliance to a grounded outlet.
12. Do not expose this projector to direct sunlight or use it outside.
- ⚠ 13. Keep all ventilation openings free of any obstructions.
14. Always open the lens shutter or remove the lens cap when the projector lamp is on.
15. Do not look directly into light beam of laser pointer. The pointer produces a strong light which could damage your eyesight.
16. The projection lamp contains mercury. Always dispose of it in a proper manner according to local regulations.
17. Always operate machine on a flat, sturdy surface.

Introduction

Product Safety Labels

The following safety labels are used on or within the MP7630B/MP7730B projector to alert you to items or areas requiring your attention.



Lamp Unit: 60.J1502.001

HIGH VOLTAGE / HIGH TEMPERATURE / HIGH PRESSURE
WHEN REPLACING THE LAMP, TURN OFF THE PROJECTOR AND PULL OUT THE CORD FROM THE RECEPTACLE BEFORE REPLACING THE LAMP. WAIT UNTIL THE LAMP BECOMES COOL (MINIMUM 45 MINUTES). TOUCHING THE LAMP WHEN IT IS HOT MAY CAUSE A BURN ON YOUR HAND. HIGH PRESSURE LAMP WHEN HOT MAY EXPLODE IF IMPROPERLY HANDLED. REFER TO USER'S GUIDE.

HAUTE TENSION / HAUTE TEMPERATURE / HAUTE PRESSION
ÉTEIGNEZ LE PROJECTEUR ET DÉBRANCHEZ LE CORDON D'ALIMENTATION DE LA PRISE AVANT DE REMPLACER L'AMPOULE. LAISSEZ REFROIDIR L'AMPOULE (U MOIN 45 MINUTES) AVANT DE LA RETIRER. POUR NE PAS VOUS BRÛLER LES MAINS, EN CAS DE MAUVAISES MANIPULATION LES AMPOULES HAUTE PRESSION RISQUENT D'EXPLOSER QUAND ELLE SONT CHAUDES. CONSULTEZ LE MODE D'EMPLOI.

HOHSPANNUNG / HOCH TEMPERATUR / HOCHDRUCK
BEIM AUSWECHSELN DER GLÜHLAMPE DEN PROJEKTOR AUSSCHALTEN UND NETZKABEL AUS DER WANDSTECKDOSE ABZIEHEN, VOR DEM AUSWECHSELN DER GLÜHLAMPE WARTEN, BIS SICH DIE LAMPE ABGEKÜHLT HAT (MINDERSTENS 45 MINUTEN) DARAUFG ACHTEN. DAB DIE HEIBE GLÜHLAMPE NICHT BERÜHRT WIRD DA DIES VERBRENNUNGEN VERURSACHEN KANN. BEI UNSACHGEMÄSSER BEHANDLUNG KANN DIE UNTER HOEHM DRUCK STEHENDE BIRNE EXPLODIEREN SICH AUF DIE BEDIENUNGSANLEITUNG BEZIEHEN.

ALTO VOLTAGGIO / ALTA TEMPERATURA / ALTA PRESSION
SE SI DEVE SOSTITUIRE LA LAMPADA, SPEGNERE IL PROIETTORE ED ESTRARRE LA SPINA DEL CAVO DI ALIMENTAZIONE DALLA PRESA DELLA RETE ELETTRICA PRIMA DI SOSTITUIRE LA LAMPADA. ASPETTARE CHE SI RAFFREDDI (ALMENO 45 MINUTI) A TOCCARE LA LAMPADA QUANDO È CALDA SI CORRE IL RISCHIO DI SCOTTARSI LA MANO. CONSULTARE LE ISTRUZIONI PER L'USO.

ALTO VOLTAJE / ALTA TEMPERATURA / ALTA PRESION
PARA REEMPLAZAR LA LÁMPARA, APAGUE EL PROYECTOR Y RETIRE EL CABLE DE ALIMENTACION DEL TOMACORRIENTE ANTES DE REEMPLAZAR LA LÁMPARA. ESPERE HASTA QUE LA LÁMPARA SE ENFRIE (ALMENOS 45 MINUTOS) SI TOCA LA LÁMPARA CUANDO ESTÁ CALIENTE, PUEDE QUEMARLE LAS MANOS. LA LÁMPARA ES ALTA PRESION CUANDO ESTÁ CALIENTE. PUEDE EXPLOTAR SI NO ES MANIPULADA DEBIDAMENTE. CONSULTE LA GUÍA DEL USUARIO.

WARNING / AVERTISSEMENT / VORSICHT / PRECAUCION
RISK OF ELECTRIC SHOCK - DO NOT OPEN. REFER SERVICING TO QUALIFIED SERVICE PERSONNEL.

POUR PRÉVENIR DE TOUT CHOC ÉLECTRIQUE, NE PAS OUVRIR L'APPAREIL. AUCUNE PIÈCE INTERNE N'EST CHANGEABLE PAR L'UTILISATEUR. POUR LA MAINTENANCE, SE RÉFÉRER AU PERSONNEL QUALIFIÉ.

GEFAHR DES ELEKTRASCHEN SCHLAGES RÜCKWAND NICHT ENTFEREN! WENDEN SIE SICH AN SERVICE - FACHPERSONAL!

PARA PREVENIR DESCARGAS ELECTRICAS, NO ABRIR LA TAPA, NI MANIPULAR EN SU INTERIOR SI NO ES POR PERSONAL CUALIFICADO.

Apparatet må kun tilkoples jordef stikkontakt.
Laitte on liitettävä suojakeskimpistorasiaan, jos se on liitetty lanjaan johdinverkkoon.
APPARATEN SKALL ANSLUTAS TILL JORDAT UTTAG NÄR DEN ANSLUTS TILL ETT NÄTVERK.

Made in / Fabrique au / Hecho en - Taiwan

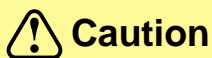
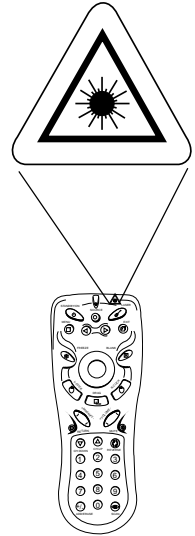

Caution

In some countries, the line voltage is NOT stable. This projector is designed to operate safely within a bandwidth of 110 to 230 volts \pm 10 volts, but could fail if power drops or surges of \pm 10 volts occur. In these high-risk areas, it is recommended to install a power stabilizer unit.

Save These Instructions

The information contained in this manual will help you operate and maintain your 3M™ MP7630B/MP7730B Personal Projector.

Introduction

Thank You for Choosing 3M

Thank you for choosing 3M multimedia projection equipment. This product has been produced in accordance with 3M's highest quality and safety standards to ensure smooth and troublefree use in the years to come.

For optimum performance, please follow the operating instructions carefully. We hope you will enjoy using this high performance product in your meetings, presentations, and training sessions.

Warranty

Limited Warranty

3M warrants this product against any defects in material and workmanship, under normal usage and storage, for a period of two years from date of purchase. Exclusion to Warranty: The lamps are considered a consumable item and are warranted for 90 days or 180 hours, whichever occurs first. Proof of purchase date will be required with any warranty claim. In the event this product is found to be defective within the warranty period, 3M's only obligation and your exclusive remedy shall be replacement of any defective parts (labor included). To obtain warranty service, immediately notify the dealer from which you purchased the product of any defects. In the USA call 1-800-328-1371 for warranty or repair service.

Limitation Of Liability

THE FOREGOING WARRANTY IS MADE IN LIEU OF ALL OTHER WARRANTIES, EXPRESSED OR IMPLIED, AND 3M SPECIFICALLY DISCLAIMS ANY IMPLIED WARRANTY OF MERCHANTABILITY AND FITNESS FOR A PARTICULAR PURPOSE. 3M SHALL NOT BE LIABLE FOR ANY DAMAGES, DIRECT, CONSEQUENTIAL, OR INCIDENTAL, ARISING OUT OF THE USE OR INABILITY TO USE THIS PRODUCT.

Important: The above warranty shall be void if the customer fails to operate product in accordance with 3M's written instructions. This warranty gives you specific legal rights, and you may have other rights which vary from state to state.

FCC STATEMENT - CLASS B: This equipment generates, uses and can radiate radio frequency energy and, if not installed and used in accordance with the instructions, may cause harmful interference to radio communications. However, there is no guarantee that interference will not occur in a particular installation. If this equipment does cause harmful interference to radio or television reception, which can be determined by turning the equipment off and on, the user is encouraged to try to correct the interference by one or more of the following measures:

- Reorient or relocate the receiving antenna.
- Increase the separation between the equipment and receiver.
- Connect the equipment into an outlet on a circuit different from that to which the receiver is connected.
- Consult the dealer or an experienced radio/TV technician for help.

Instructions to Users: This equipment complies with the requirements of FCC (Federal Communication Commission) equipment provided that following conditions are met. The cables (power cord, RGB cable and other cables) may have to be used with the core set to the projector side. Use the cables which are included with the projector or specified.

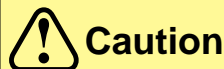
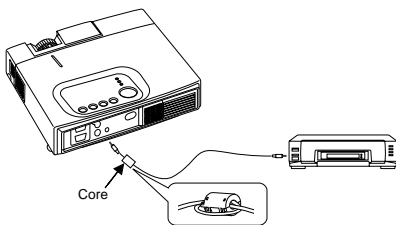

Caution

Changes or modifications not expressly approved by the party responsible for compliance could void the user's authority to operate the equipment.

NOTICE: This Class B digital apparatus complies with Canadian ICES-003.

Pour les utilisateurs au Canada

AVIS: Cet appareil numérique de la Classe B est conforme à la norme NMB-003 du Canada.

EEC STATEMENT: This machine was tested against the 89/336/EEC (European Economic Community) for EMC (Electro Magnetic Compatibility) and fulfills these requirements.

Video Signal Cables: Double shielded coaxial cables (FCC shield cable) must be used, and the outer shield must be connected to the ground. If normal coaxial cables are used, the cable must be enclosed in metal pipes or in a similar way to reduce the interference noise radiation.

Video Inputs: The input signal amplitude must not exceed the specified level.

Patents, Trademarks & Copyrights

IBM is a registered trademark of **International Business Machines Corporation**. **Apple Macintosh** and **Apple Powerbook** are registered trademarks of **Apple Computer, Inc.** **Microsoft** and **Windows 95** and **Windows 98** are registered trademarks, and **Windows** and **Windows for Workgroups** are trademarks of the **Microsoft Corporation**. **Toshiba** is a registered trademark of **Toshiba Corporation**. All other products are trademarks or registered trademarks of their respective companies.

Introduction

Shipping Box Contents

The 3M™ MP7630B/MP7730B Personal Projector is shipped with the necessary cables required for standard VCR, PC, Macintosh™ or laptop computer connections. Carefully unpack and verify that you have all of the items shown below. If any of these items are missing, please contact your place of purchase.



MP7630B/MP7730B
Personal Projector

Remote Control
Transmitter

2-Prong
Adapter with
Ground

Mac
Adapter

Power Cords
US, UK, Europe

VGA
Cable

General
Cable

PS/2
Mouse Adapter Cable

Serial
Mouse Adapter Cable

ADB
Mouse Adapter Cable

Soft-side
Carrying
Case

Operator's Guide
(CD-ROM)

Quick Start
Guide

Product Safety
Guide

Product Registration
Card

Lens Cover

Batteries

Optional Accessories

- Video Module (RCA with tuner) (1)
- Video Module (SCART without tuner) (1)

✓ **Note:** For more information on the Optional Video Module and its functions, please see the *Optional Video Module* section of this manual.

✓ **Note:** Save the shipping box and packing materials in the event the MP7630B/MP7730B should require shipping to a 3M Service Center for repair.

What's Next?

After you have unpacked the MP7630B/MP7730B and identified all the parts, you are ready to set up the projector.

Please read this guide thoroughly before operating your new projector.

Be sure to check our web site (www.3m.com/meetings) regularly for updates and supplemental information. On the CD-ROM, you can link directly to the web site by clicking [here](#) or on "3M Innovation" in the lower right corner of the Main Menu.

Introduction

Part Identification

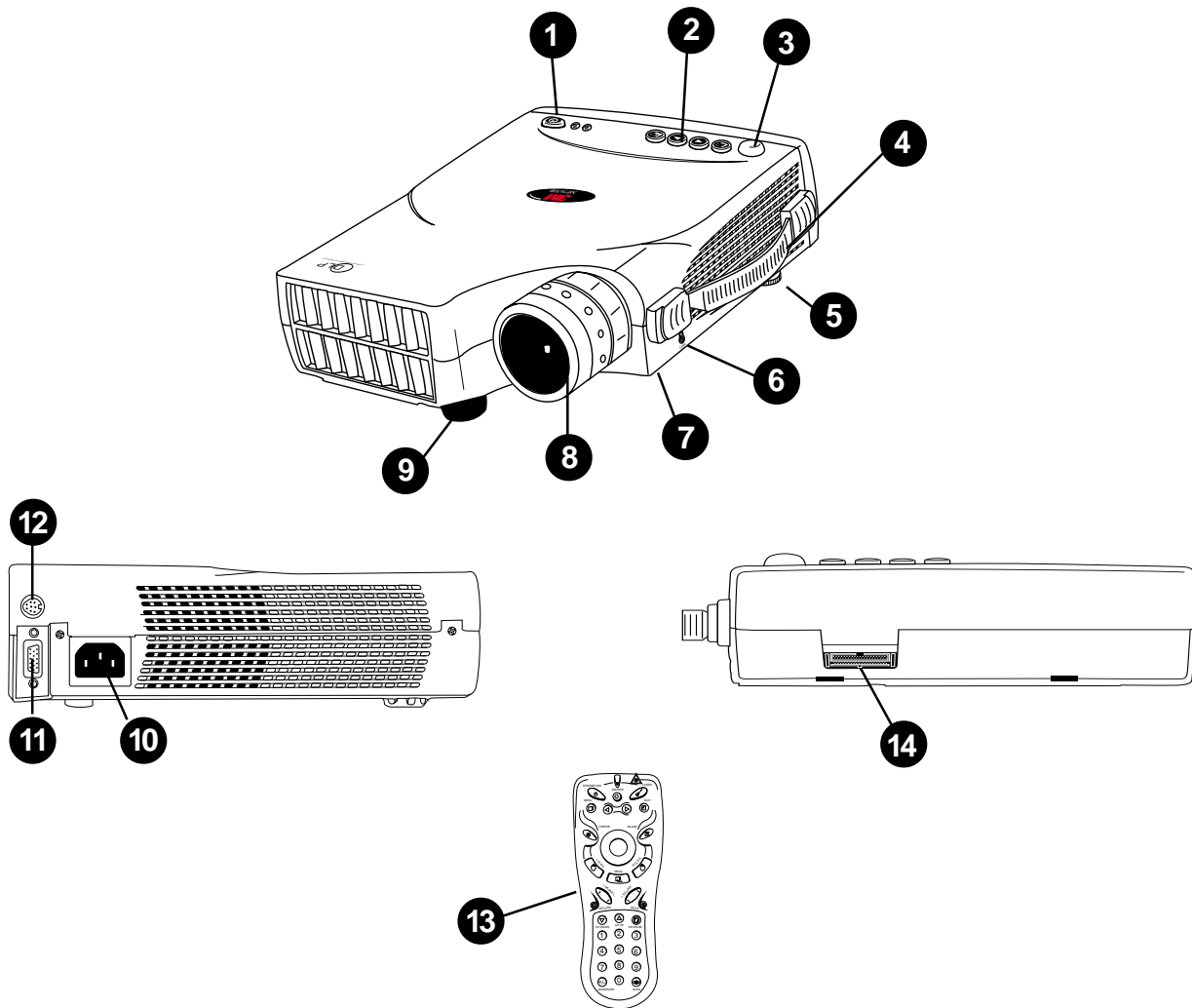

1. Standby/On Button
2. External Control Pad (see next page)
3. Remote Control Sensor
4. Carrying Handle
5. Image Tilt Control
6. Kensington Lock Slot
7. Lamp Access Door (underneath unit)
8. Projection Lens
9. Height Adjustment Foot
10. AC Power Cord Input
11. Serial Port Terminal Connection
12. Mouse Control Port (Serial • PS/2 • ADB)
13. Remote Control Transmitter
14. Video Module Connection

Introduction

Machine Characteristics

The MP7630B/MP7730B Personal Projector integrates ultra-high bright lamp and TI™ DLP™ technology into a single unit.

The MP7630B/MP7730B Personal Projector offers the following features:

- Small and portable unit
- Easy to set up and use
- SVGA resolution and component video compatible (MP7730B: XGA resolution)
- Horizontal and vertical image inverting
- Horizontal and vertical image position control
- Ultra-high brightness projection lamp
- Ability to display 16.7 million colors
- Full function remote control
- Digital keystone correction
- IR remote control sensor on top
- On screen menus in seven languages
- Color balance control for data/video
- RS-232 control capability

The MP7630B/MP7730B Personal Projector offers the following optional features:

- Attachable video module
- Cable television (CATV) tuner

✓ *Note: The brightness of your machine will vary depending on the ambient room conditions and contrast/brightness settings.*

External Control Pad Buttons

The External Control Pad is located on top of the projector, near the back end.

The **Infrared Remote Receivers** allow the projector to accept signals from the remote control. For best results, be sure to aim the control toward the sensors, without any obstructions between the two, and at a distance no greater than 4 meters (13 feet).

The **Menu** button will display the menu system onscreen. Press **Menu** again to access the sub-menus.

The **Keystone** buttons help correct keystone distortion of a projected image. The **Keystone +** button corrects distortion in the upper part of the image. The **- Keystone** corrects it in the lower part. When you are viewing the onscreen menus, the **Keystone** buttons help navigate among choices and settings in the sub-menus.

Press the **Auto** button to automatically adjust a projected image on screen. When you are viewing the onscreen menus, press **Auto** to go back to the Main Menu. Press **Auto** again to exit the menu system.

The **Lamp Status Indicator** will blink or light up when the lamp needs service, cooling or replacement. See page 34 for more detailed information.

When the projector is turned on, the **Standby/On Indicator** will blink during warm-up and lamp ignition, then stay green to indicate the projector is ready for use.

Press the **Standby/On Button** to turn the projector on or off.

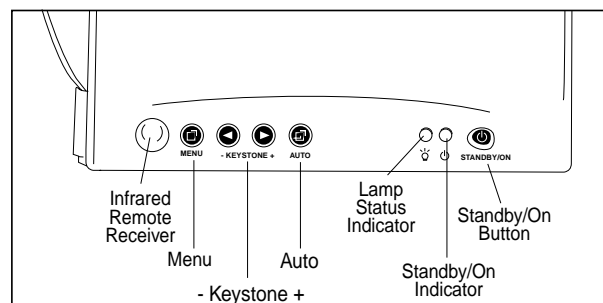

Introduction

Remote Control Identification

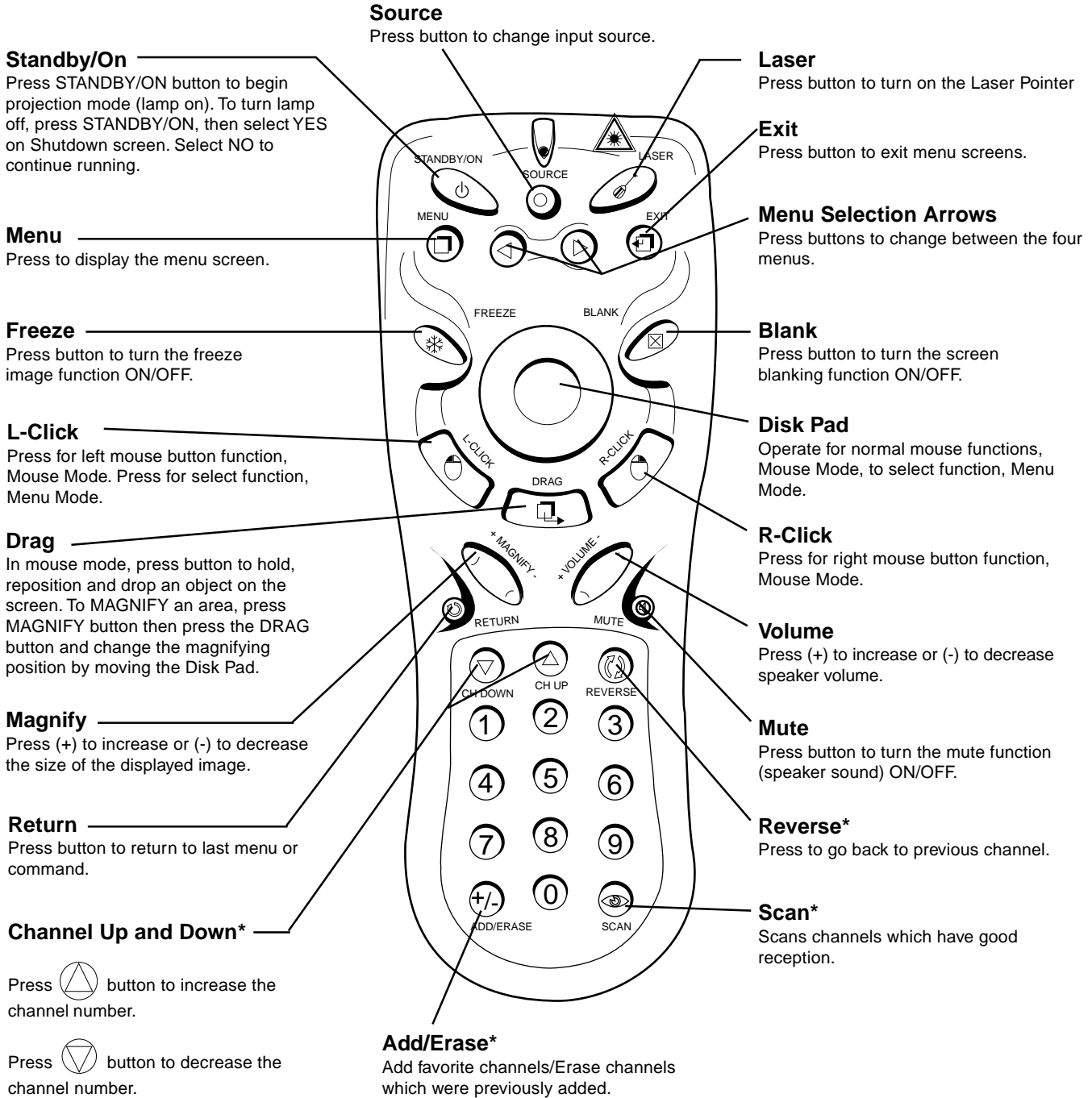

**✓ Note: These features are for use only with the optional video module.*

Introduction

Remote Control Features

The remote control sensor is located near the back of the projector. The distance between the sensor and the remote control unit must be shorter than 4 meters (13 feet).

Freeze

The image will be frozen when the **Freeze** button is pressed. A “Pause” icon appears at the lower right of the screen for three seconds during the freeze function. A “Play” icon appears at the lower right of the screen for three seconds when the freeze function is released. To release the freeze function, press the **Freeze** button or **Source** button (when the input source is switched over during display).



Freeze button



“Pause” icon



“Play” icon

Mute

Pressing the **Mute** button will mute the sound. A text box saying “Mute” appears at the lower right of the screen. Press **Mute** button again or **Volume** + or - button to release the function.



Mute button

Volume

Press the **Volume** + or - button to adjust the loudness. The volume slide bar will disappear three seconds after the last adjustment is made.



Volume button

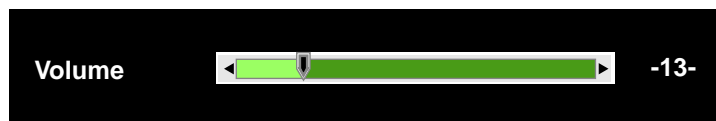

Magnify

By pressing **Magnify** +, the center of the picture can be magnified, doubling in size. When the button is pressed again, the picture is further magnified, up to four times the original size. By pressing **Magnify** -, the size of the image is reduced to half its size. When the button is pressed again, the picture is further reduced until it is restored to the original size. To return to the normal display mode, press the **Return** button. (This function can be used in combination with the **Freeze** function.)



Magnify button



Magnify icon

Introduction

Laser

Press this button to generate the laser beam that functions as a red pointer on the screen.



Laser button

Disk Pad

If the PS/2 (ADB) mouse cable is connected with the PC Notebook or Mac PowerBook mouse port, the **Disk Pad** can take over the Notebook or PowerBook mouse function. When the **Magnify** function is activated, use the **Disk Pad** to move around the display areas.

Note: The mouse function is not available when the Magnify function is turned on.

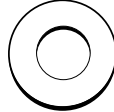

Disk Pad button

R-Click, L-Click

These two keys are used when the mouse function is activated after the PS/2 port is connected. They act as the right (R) and left (L) buttons of a computer mouse.



L-Click button

R-Click button

Drag

This button toggles between ON and OFF for the drag function of the remote mouse.

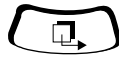

Drag button

Blank

Press this button to activate or release the **Blank** function. **Blank** makes the screen go blank.



Blank button

Installing or Replacing Batteries

- Push and slide the battery compartment lid in the direction shown.
- Install two AAA batteries as indicated by the diagram inside the compartment.
- Position the lid over the compartment and snap back into place.

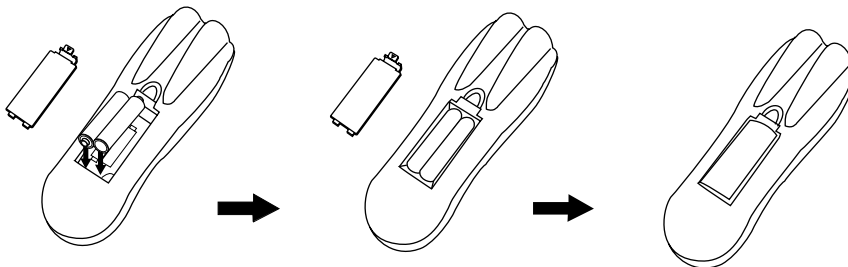

Caution

- Avoid excessive heat and humidity.
- Do not mix old and new batteries or different types of batteries.

System Setup

Screen Chart

Place the projector at the required distance from the screen according to the desired picture size (see the table below).

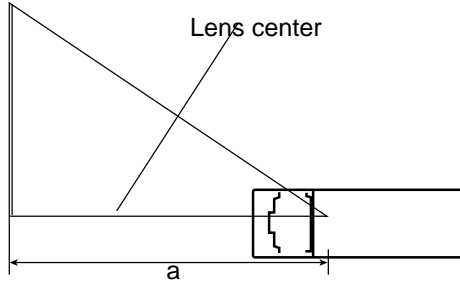

Distance to Screen		Screen Size		
Minimum	Maximum	Diagonal	Width	Height
6.0 ft. 1.8 m	8.0 ft. 2.4 m	40.0 in. 101.6 cm	32.0 in. 81.3 cm	24.0 in. 61.0 cm
9.0 ft. 2.7 m	12.0 ft. 3.7 m	60.0 in. 152.4 cm	48.0 in. 121.9 cm	36.0 in. 91.4 cm
12.0 ft. 3.7 m	16.0 ft. 4.9 m	80.0 in. 203.2 cm	64.0 in. 162.6 cm	48.0 in. 121.9 cm
15.0 ft. 4.6 m	20.0 ft. 6.1 m	100.0 in. 254.0 cm	80.0 in. 203.2 cm	60.0 in. 152.4 cm
18.0 ft. 5.5 m	24.0 ft. 7.3 m	120.0 in. 304.8 cm	96.0 in. 243.8 cm	72.0 in. 182.9 cm
23.0 ft. 7.0 m	30.0 ft. 9.1 m	150.0 in. 381.0 cm	120.0 in. 304.8 cm	90.0 in. 228.6 cm
31.0 ft. 9.4 m	40.0 ft. 12.2 m	200.0 in. 508.0 cm	160.0 in. 406.4 cm	120.0 in. 304.8 cm

Note: These sizes are $\pm 1\%$. This is due to variations in the manufacture of the lens. If you are close to one of the endpoints you should verify with your unit that the image is the proper size at the proper distance.

For your own customized screen chart, please click [here](#)

Digital Keystone Correction

Keystoning is when the projected image is noticeably wider on either the top or bottom. There are two ways to correct this:

1. Press **Menu** on the remote control or projector, then select the **Display** menu (first menu bar button on the left), then adjust the sliding bar labeled **Keystone**, as needed.
2. Use the **Keystone** buttons on the external control pad. Pressing the + button will correct keystoning at the top of the image. Pressing the - button will correct keystoning at the bottom of the image.

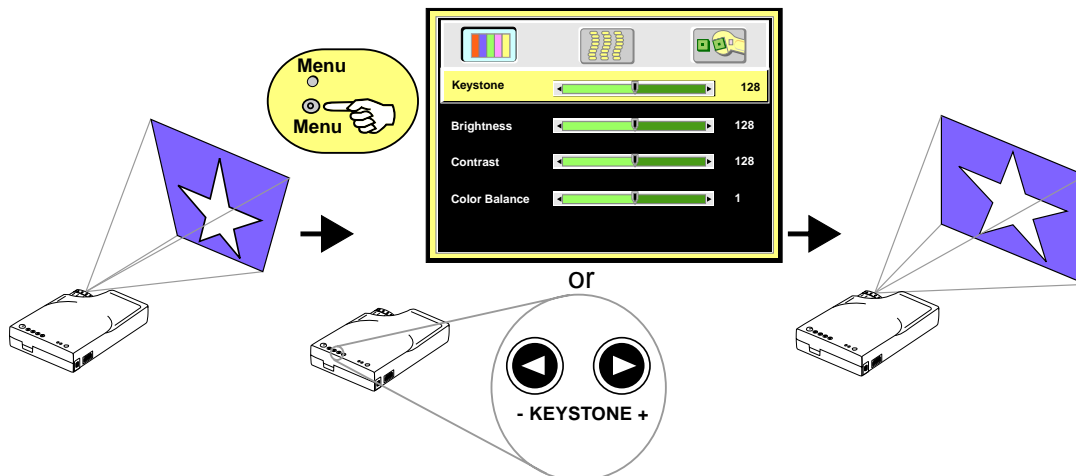

System Setup

Connecting to Various Equipment

It only takes a few minutes to connect the 3M™ Personal Projector MP7630B/MP7730B to your computer, VCR, or other device.



Caution

- Turn off power to all devices before making connections. Never plug anything into the projector or computer while any device is in operation.
- The MP7630B/MP7730B must be powered down when making connections. The mouse emulation may not work if the unit is not powered down before the mouse cable connections are made.

Connection Terminals

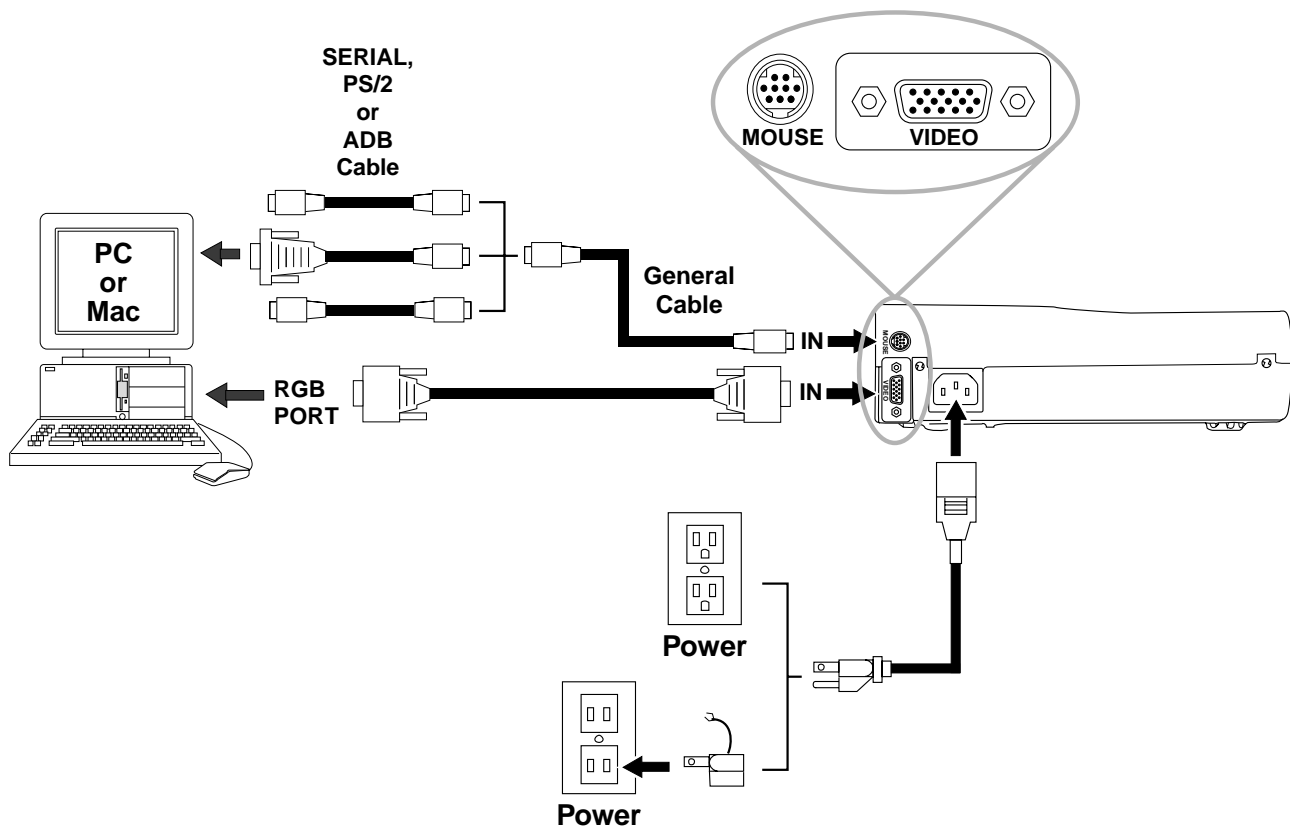

Mouse Connection

The general cable links the projector to the proper mouse adapter cable for your computer.

1. Attach the male Mini-DIN end of the general cable to the Mouse port on the rear of the projector.
2. Attach the female Mini-DIN end of the general cable to the end of the proper mouse adapter cable for your computer (serial, PS/2 or ADB cable). Line up the arrows on the sides of the plugs before attaching. Be sure not to bend or break the small metal pins inside the plugs.
3. Attach the other end of the mouse adapter cable to the proper port on your computer (serial, PS/2 or ADB).

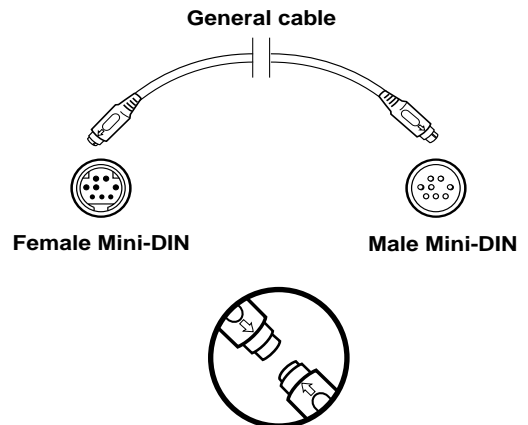

Apple™ Desktop Mouse

The Macintosh operating system should recognize the MP7630B/MP7730B as a mouse without any drivers being loaded.

VirtualMouse for PC Computer

For IBM™ compatible computers, set the operating systems to **Serial Mouse** or **PS/2 Mouse** to recognize projector as the mouse pointer device.

To set mouse driver information:

a) **Windows™ 95/Windows™ 98/Windows™ NT**

1. Select **Start/Settings/Control Panel**.
2. Select **Add New Hardware**.
3. “Windows will now search for any PnP devices...” Click **Next**.
4. **Hardware Types:** Scroll down to **Mouse**. Click **Mouse**.
5. Select **Manufacturer: Standard Mouse Type**
6. Select **Model: Standard Serial Mouse**
7. Click **Next, Finish, Start**.
8. Restart Windows if prompted.

b) **Windows™ 3.1**

From *Program Manager*

1. Click **Main**
2. Click **Windows Setup** (make note of the current mouse driver)
3. Click **Options**
4. Then **Change Systems Settings**
5. Choose **Mouse**
6. It should be listed as *Microsoft or IBM PS/2*

✓ **Note:** *For proper mouse operation, always turn the projector power on first and power up the computer. For some laptop computers, you may need to disable the internal pointing device (IPD). This is done through the BIOS level set-up of the particular machine, or it could be listed in a “Utilities” program group, i.e., “Toshiba Utilities™,” or “Thinkpad Features™.”*

Startup

1

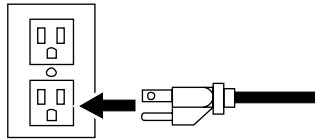

Power

✓ *Note: Make all cable connections and line hookups with the power off.*

2

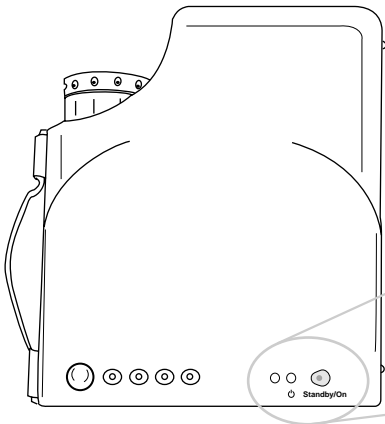

Ground lead

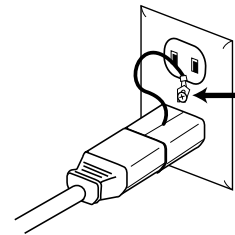
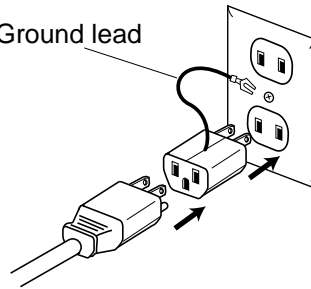

The 2-prong adapter with ground is used with older U.S. electrical outlets that only support 2-prong power cord plugs.

✓ *Note: When using this adapter, the ground lead **MUST** be securely fastened to the ground screw on the outlet.*

Plug the 2-prong adapter into the bottom socket of the electrical outlet. Hook the end of the ground lead firmly around the neck of the outlet's ground screw. Tighten the screw, if necessary, to hold the ground in place. Then plug the power cord into the adapter.

1. Plug power cord into wall socket. Wait 5 seconds before pressing the **Standby/On** button.

2. Press the **Standby/On** button and hold for 3 seconds.

- The ON indicator will blink green during warm-up and lamp ignition.
(When power is turned off, there is a 90-second reset period before the **Standby/On** button will function again.)

3. Turn on all connected equipment.

✓ *Note: If you have the Optional Video Module attached to the unit, press the Source button on the remote to select the source of the signal to be projected onto the screen. The selected signal input is displayed at the top right of the screen. The display will show the last selected input source before power was turned off. (For more information, please refer to the Optional Video Module section of this manual.)*

Operation

Shutdown

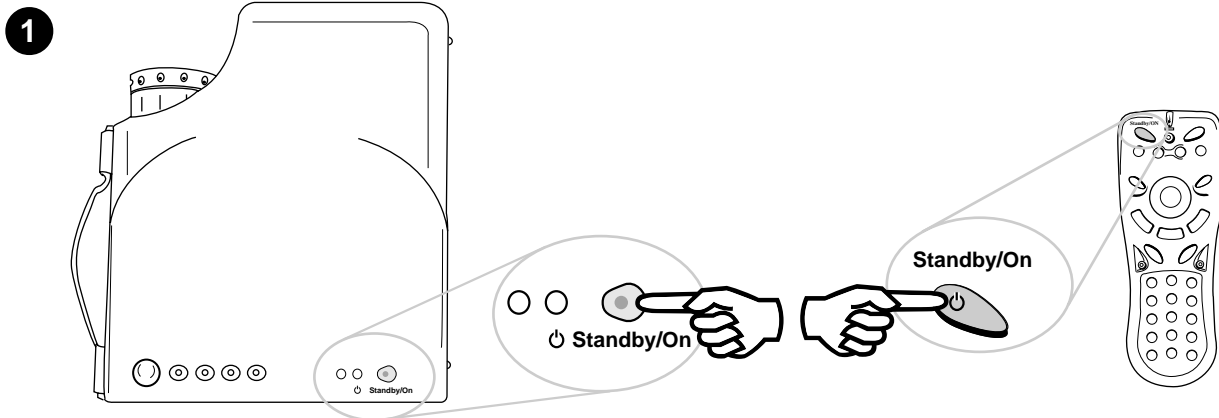

2 Wait 90 seconds

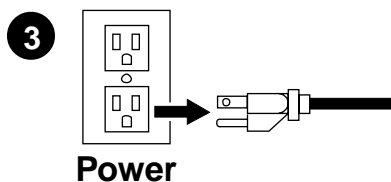
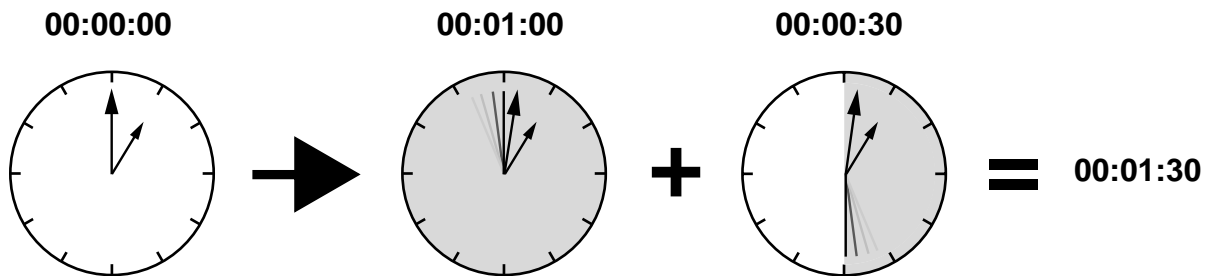

1. Press the **Standby/On** button. The Shutdown screen will display. Select the YES option (press - **Keystone** + buttons or **Disk Pad** button) to turn off.
2. The fan will continue to run for approximately 90 seconds.
3. Disconnect power cord from wall socket.
4. Disconnect cables if moving projector to new location.



Caution

Do not unplug power cord before pressing the **Standby/On** button. After the **Standby/On** button is pressed, the fan rotates for about 90 seconds to cool the projector.

Main Menu

Press **Menu** on the remote control or external control pad, and the main menu will display on the screen. Press **Menu** again to enter page items, and press **Keystone** buttons to select sub-menus. The main menu will go off automatically if there is no further action from user for 10 seconds. Press the **Auto** button to leave the current sub-menu, and press **Auto** again to leave the main menu.

Menu Pages

MENU LAYOUT	Display Menus	Image Menus	Control Menus	Source Menu <i>(only with Video Module)</i>
Without Optional Video Module	Keystone Brightness Contrast Color Balance	Auto Size Horizontal Phase Horizontal Sync Horizontal Position Vertical Position	Language Mirror Blank Auto Off Reset	(not applicable)
PC or Mac with Optional Video Module	Keystone Brightness Contrast Sharpness	Auto Size Horizontal Phase Horizontal Sync Horizontal Position Vertical Position	Language Mirror Blank Auto Off Reset	Source Volume Treble Bass Mute
Video Input with Optional Video Module	Keystone Brightness Contrast Color Balance	Tint Sharpness Image Ratio System	Language Mirror Blank Auto Off Reset	Source Volume Treble Bass Mute

Menu Navigation

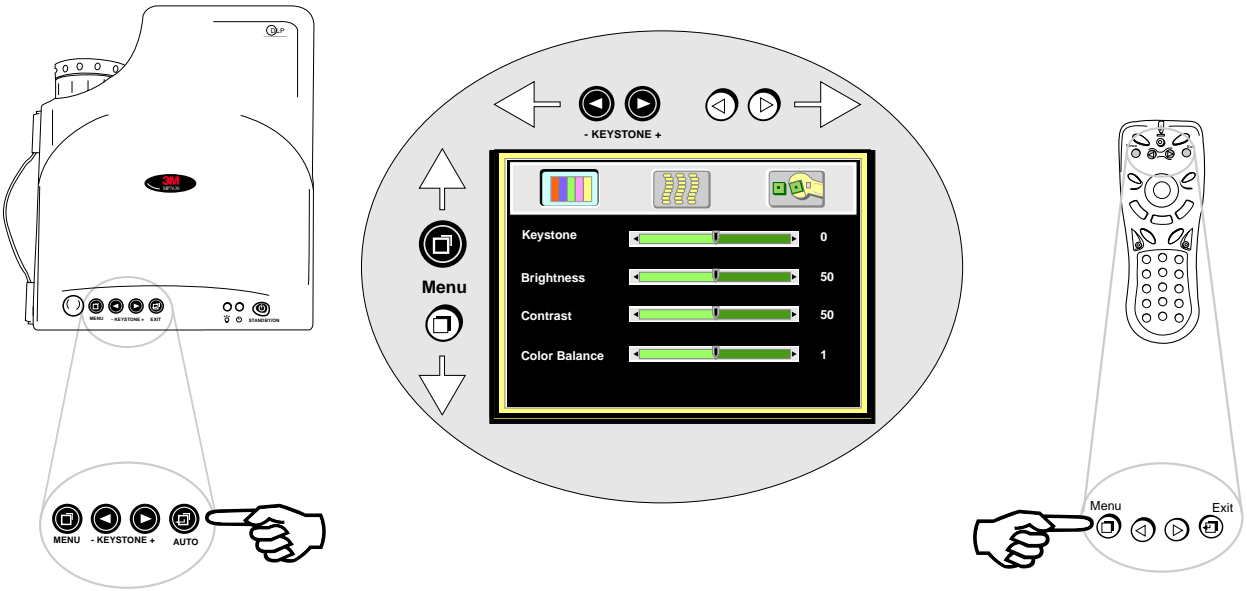

To Menu Items

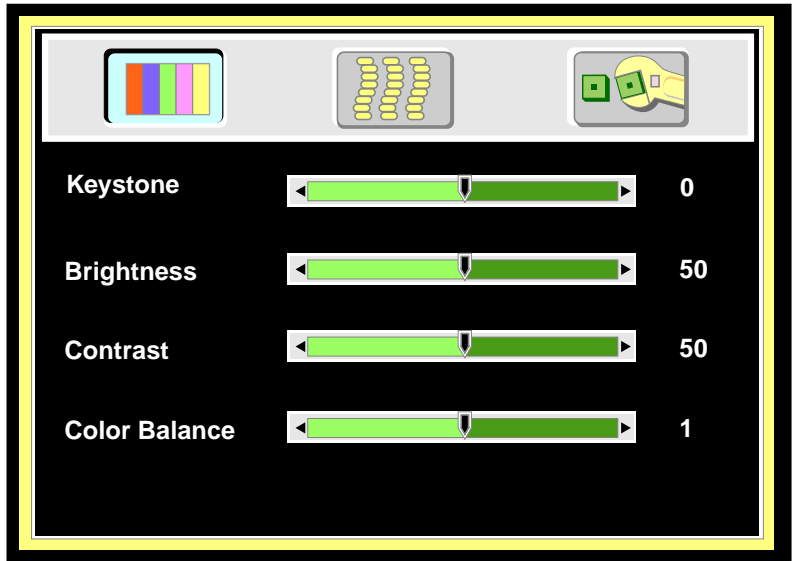

Display Menu

Operation

Display Menu

Keystone (0-255)

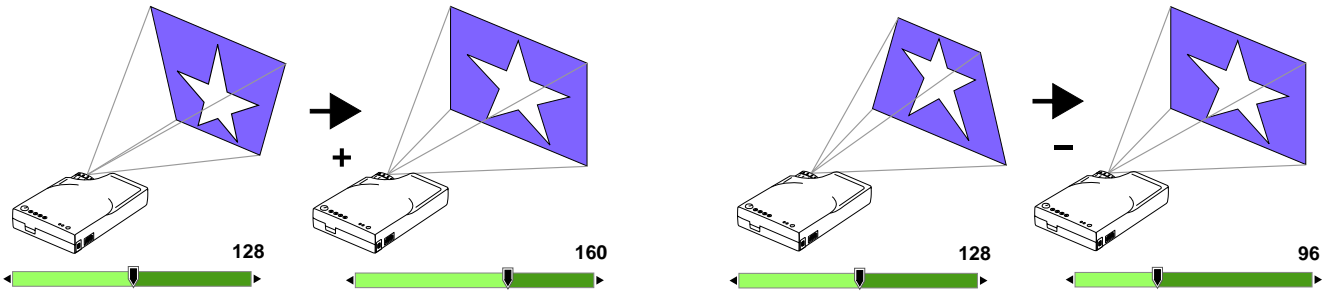

Brightness (0-255)

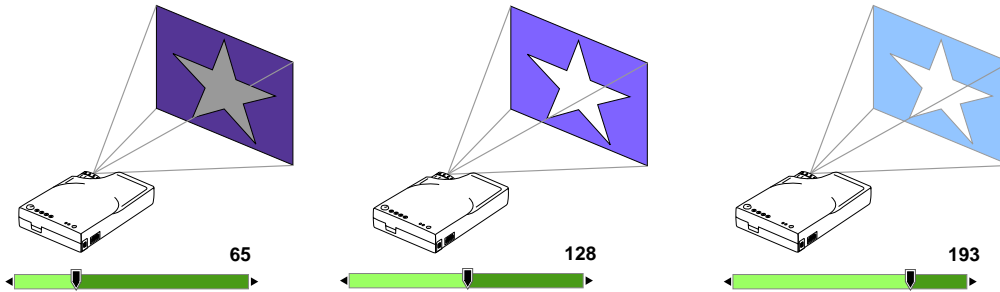

Contrast (0-255)

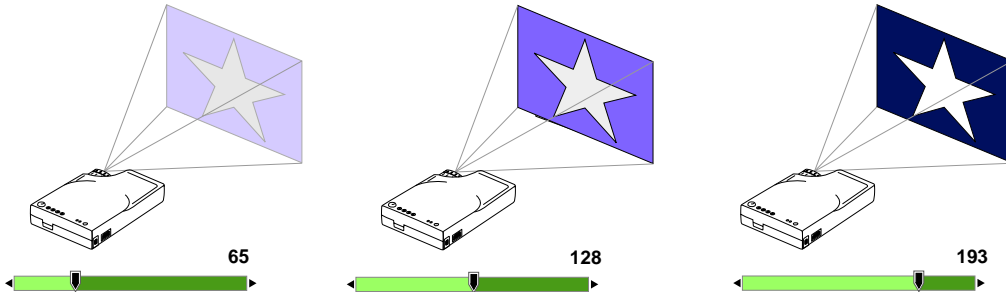



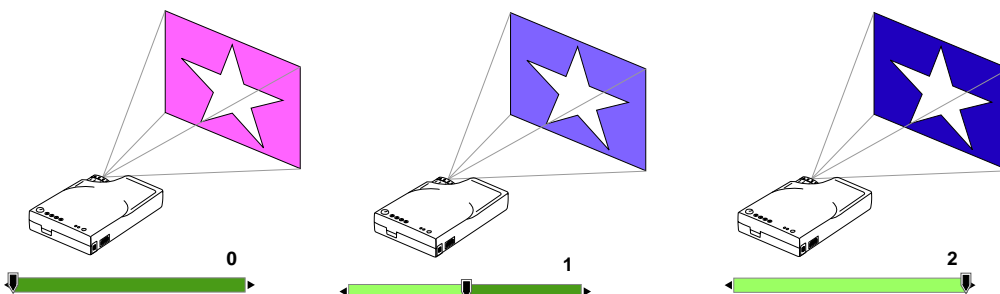





Color Balance (0-2)



Operation

Image Menu

To Menu Items

- 1 **Menu**    **X1**
- 2    **X1**
- 3 **Menu**    **X1**

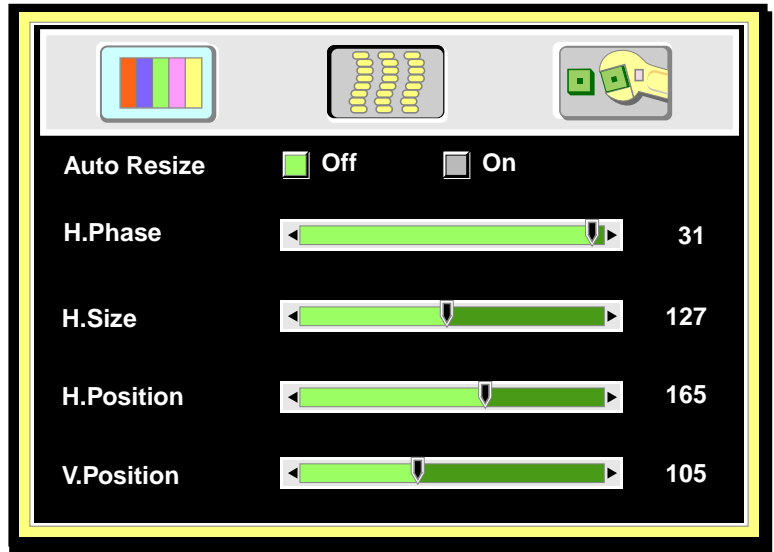

Auto Resize

Will automatically adjust image to fit onto screen.

Off On

Horizontal Phase

(Auto Resize OFF)

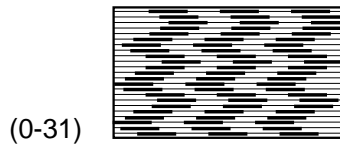

Horizontal Size

(Auto Resize OFF)

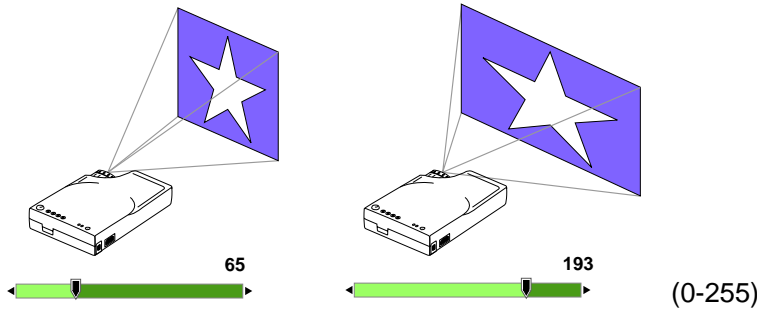

Horizontal Position

(Auto Resize OFF)

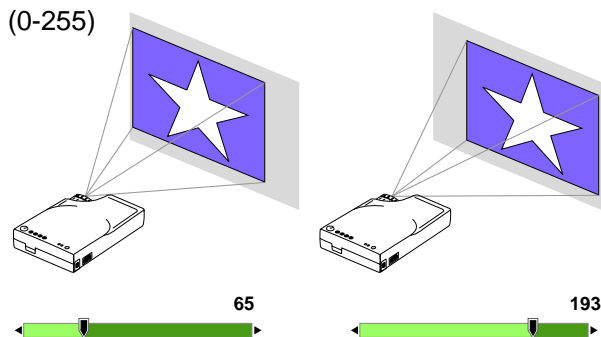





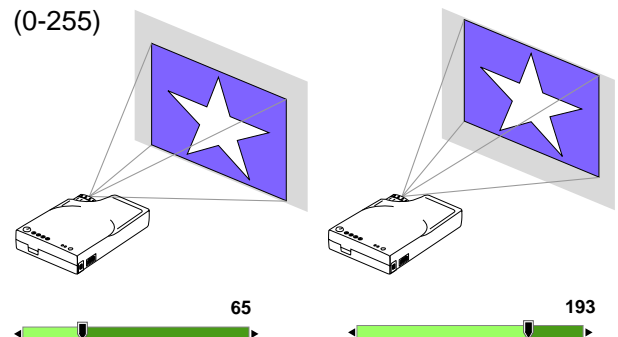



Vertical Position

(Auto Resize OFF)



Control Menu

To Menu Items

- 1 MENU    **x1**
- 2    **x2**
- 3 MENU    **x1**

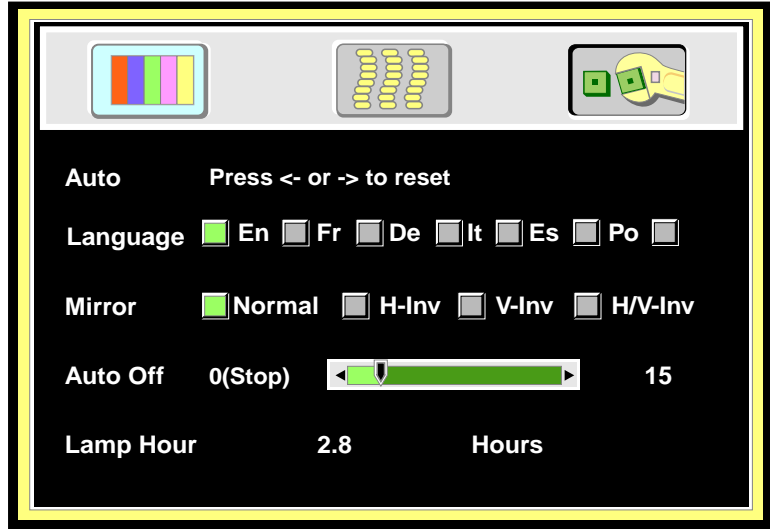

Auto

Will automatically adjust projected image.

Language

English (En) French (Fr) Deutsch (De) Italian (It) Español (Es)
Portuguese (Po) Simplified Chinese ()

Mirror

Will invert image to display properly according to position of projector.

Normal
(Default)

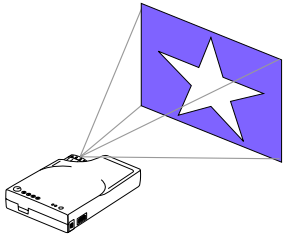

H-Inv (Horizontally Inverted)
(Rear-screen projection)

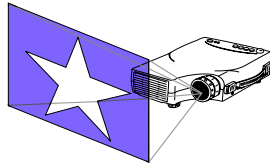

V-Inv (Vertically Inverted)
(Ceiling mounted)

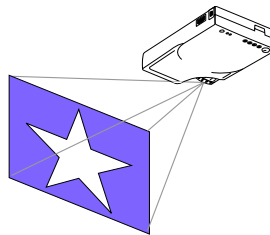

H/V-Inv (Horizontally/Vertically Inverted)
(Rear-screen projection, ceiling mounted)

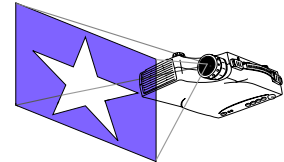

Auto Off

Will turn off the power in 60 minutes.

00:00:00

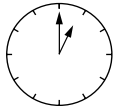

00:60:00

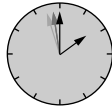

Lamp Hour

Will reset the lamp hours after lamp is changed.

Optional Video Module

Features

The Optional Video Module makes it possible to hook the MP7630B/MP7730B to a laser disc, VCR, or other video devices. Two versions will be available: an NTSC Package (with RCA connectors and television tuner), and a PAL package (with a SCART connector and no television tuner).

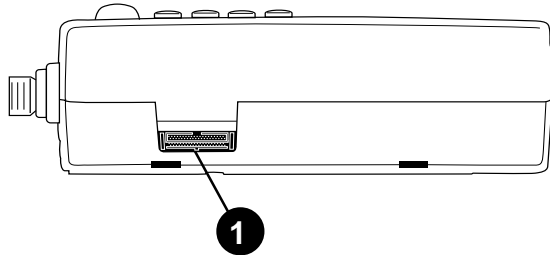

Back of projector without Optional Video Module

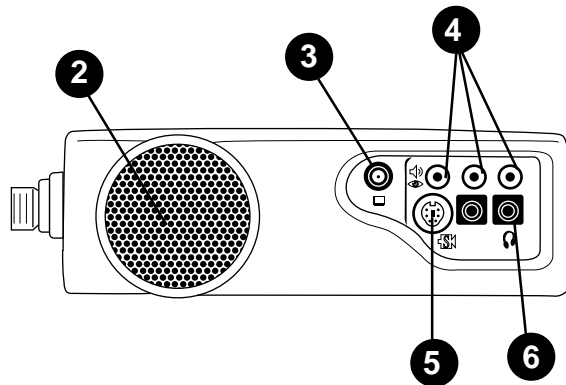

Back of projector with NTSC Tuner Module

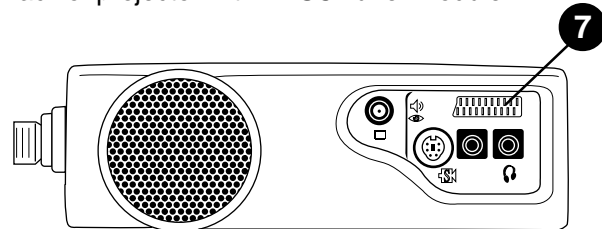

Back of projector with PAL SCART Module

NTSC Package:

- NTSC Tuner Module
- CATV
- S-Video
- 3 RCA
- Audio

PAL Package:

- PAL Video Module
- S-Video
- SCART connector
- Audio

1. Video Module Connection
2. Speaker
3. Cable Television (CATV) Connection
4. RCA Cable Connection
 - (a) Video (Yellow)
 - (b) Audio (White/Red)
5. S-Video Connection
6. Headphone Jack
7. SCART Connection

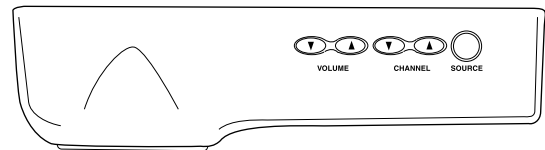

Top view of video module

Optional Video Module Connections

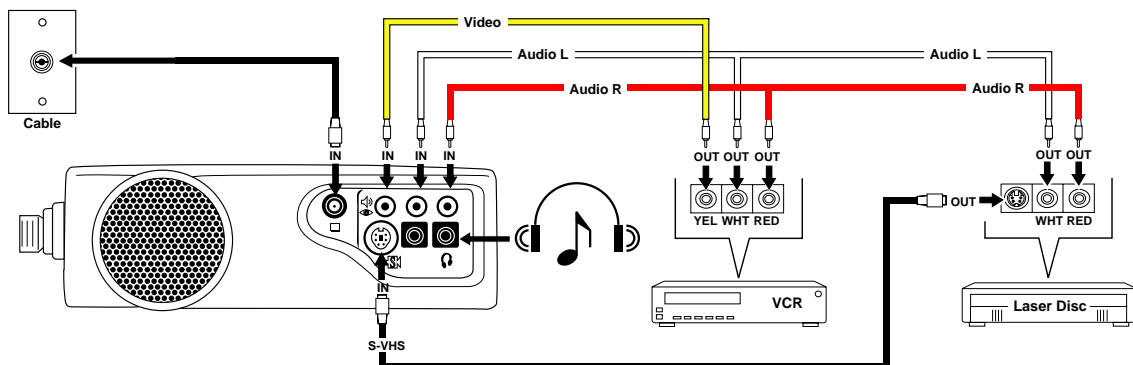

Optional Video Module

Attaching the Optional Video Module to the MP7630B/MP7730B

 **Caution** Power down the projector before connecting the Optional Video Module or any other device. Failure to do so may cause serious damage.

1. Precisely align the two metal tabs on the bottom of the module and insert into the corresponding slots on the back of the projector.
2. Slowly push the module to fit with the unit. Make sure that the module plugs into the AV connection on the projector.
3. Plug the correct cable into the corresponding jack or port in the back of the unit.
4. Select inputs by pressing the **Source** button, and select the appropriate source channel by pressing the **Channel Up/Down** buttons.

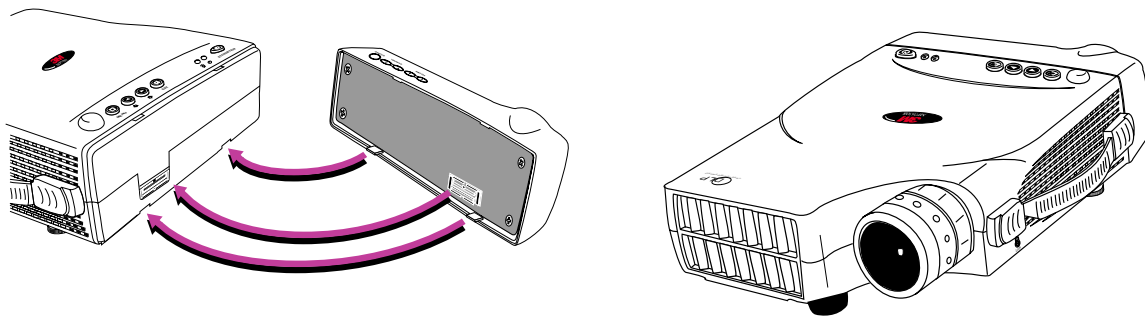

Switching Input Signals

Pressing the **Source** button on the remote control or the projector will cycle between these choices of input signals: **RGB** (computer), **Video** (composite video from a VCR), **S-Video**, and **Tuner**. The projector will then search for the selected type of signal until it is found or switched to another type.



Scanning Channels

The MP7630B/MP7730B can receive over 100 television channels. In **Tuner** mode (TV and CATV), press the **Scan** button on the remote control to view all available television channels. The message “DO YOU REALLY WANT TO SCAN? YES NO” will appear onscreen. Press either the left or right arrow buttons on the remote to reach Yes or No, then press the **Menu** button to enter the selected answer. The message “TUNER IS SCANNING NOW” will display for a few seconds, and then the scanned channels will appear for a few seconds each.



Optional Video Module

Image Sub-Menu

This menu is only available when the input signal is from Video, S-Video, TV or CATV.

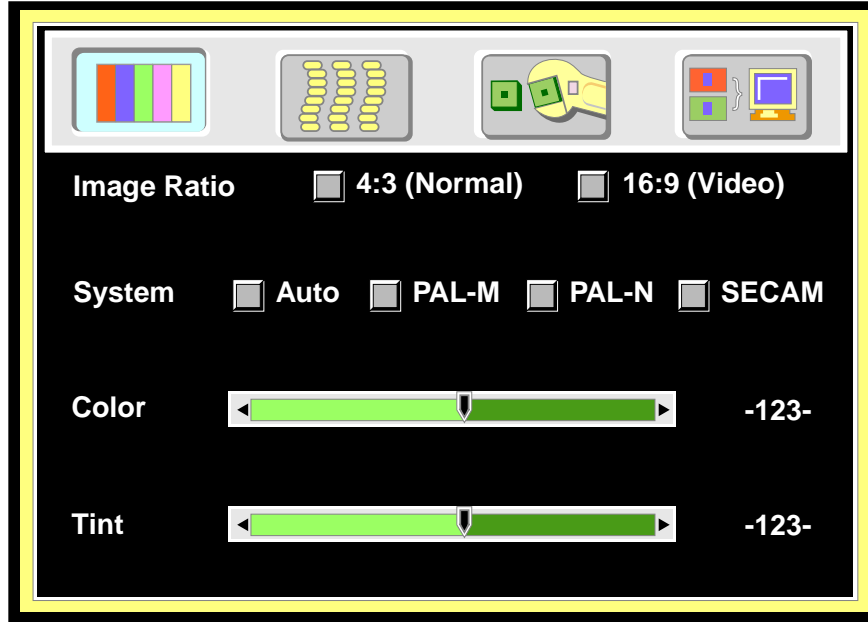

Color

Less \longleftrightarrow More

Tint

Red \longleftrightarrow Green (Source is video or S-video)

Image Ratio

4:3 (Normal) 16:9 (Video)

System

Auto PAL-M PAL-N SECAM

Optional Video Module

Operation

1. Go into the menu system and move to the **Source** sub-menu. Use the **Menu** button on the control pad or remote control unit to scroll through items in the sub-menu. Select the **Tuner** items and press the - **Keystone** + keys to prompt out of the tuner menu.

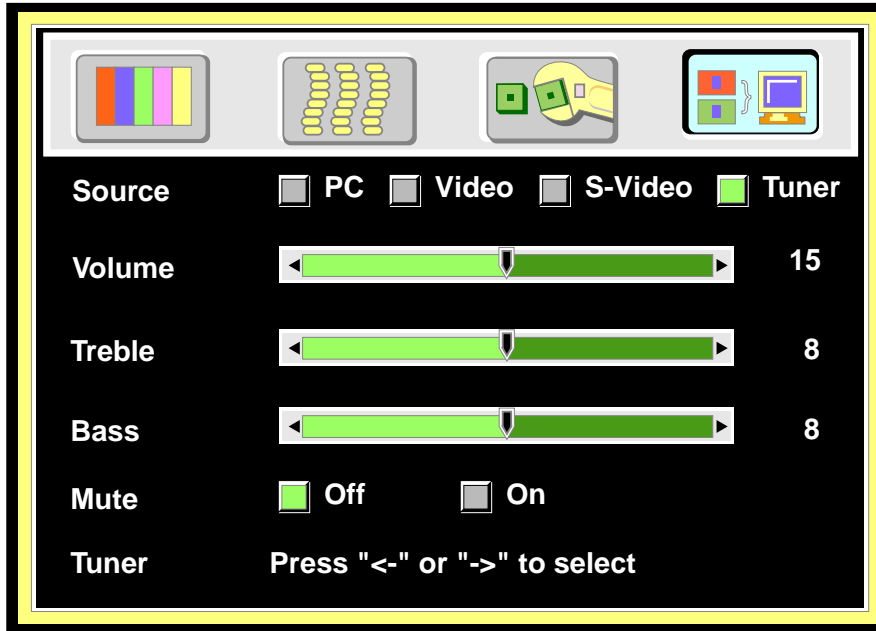

2. Use the **Menu** button on the control pad or remote control unit to scroll through the **Tuner** sub-menu.
 - **TV/CATV:** Please select the TV signal source. If the source is from CATV, please choose CATV. Otherwise, select TV.
 - **Nationality:** Please select the corresponding number representing the user's country. (See reference chart.)

✓ *Note:* The item "NONE Tuner" is only for the user's information and is not a function. For example, if current A Box is NTSC Tuner box, then "NTSC Tuner" will appear in this section.

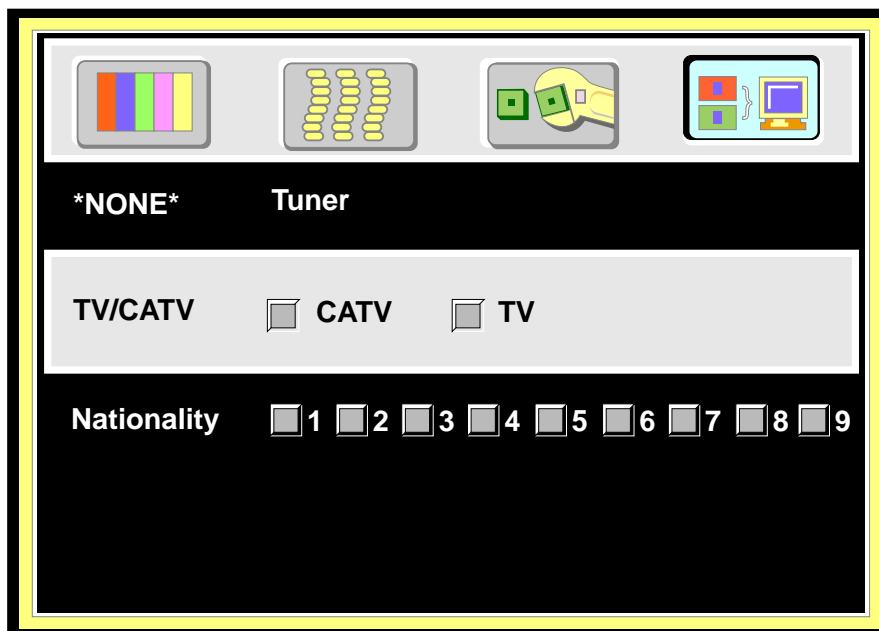

Optional Video Module

3. After leaving the menu system, press the **Scan** button to scan all existing channels in that region.
✓ *Note: Scan function must be done for the first use in certain regions to catch all the channels in the local CATV system.*

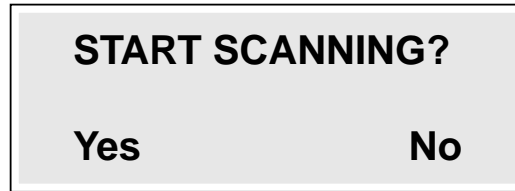

After the “START SCANNING?” dialog box prompt, use the **Channel Up/Down** buttons to select “Yes” or “No.” Press **Return** button to set.

Function (Must be performed with remote control unit)

- Channel Select** Press the channel number button user wants to select (for example, 12), then press **Return** button to set.
- Channel Up/Down** Go up and down through channels by pressing the **Channel Up/Down** buttons. The channel number will appear in the lower right corner of the screen. If there is no further action for three seconds, the channel number display will disappear automatically.



- Scan** Press the **Scan** button for two seconds to begin scanning TV channels.
- Add/Erase** Press the **Add/Erase** button for two seconds to add or erase the channel. To delete channels from memory, press the button to erase the channel. A “Channel Erased” message will display. Users can also add channels to memory by pressing the button after selecting it. A “Channel Added” message will display.











- Reverse** Press the **Reverse** button to toggle between the previous and current channels.

Optional Video Module

Source Menu

To Menu Items

- 1** Menu    **x1**
- 2**    **x3**
- 3** Menu    **x1**

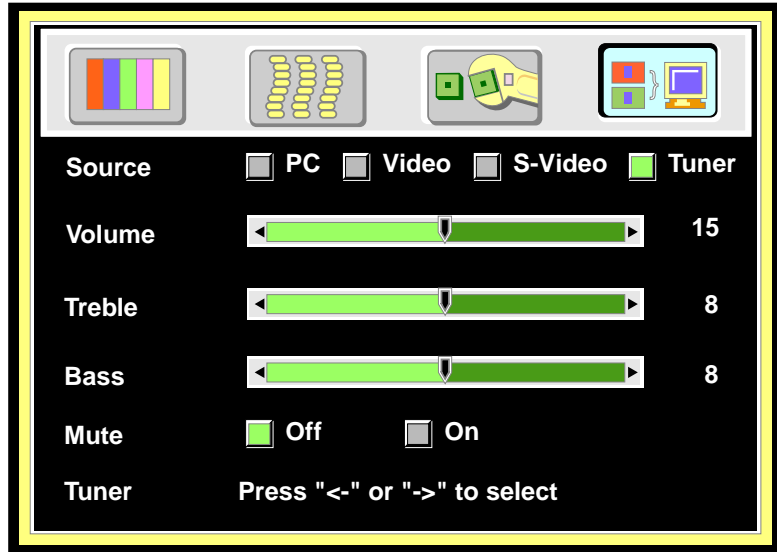

Source

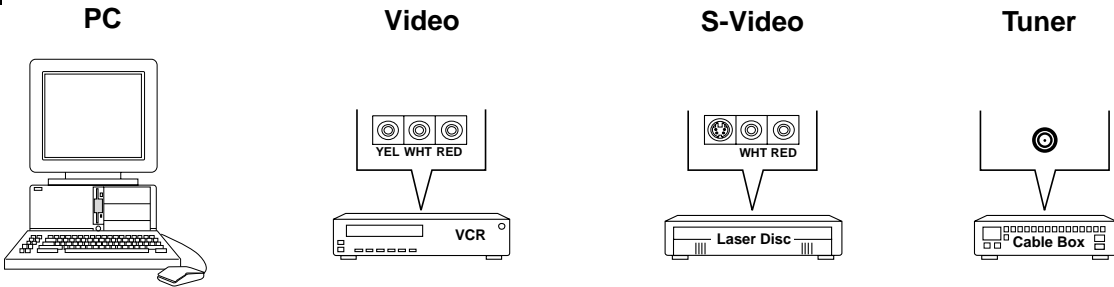

Volume

(0-29)

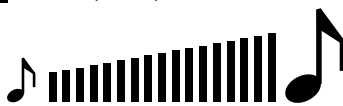

Treble

(0-15)



Bass

(0-15)



Mute

Off

On



Lamp Usage

Use and Replacement of Lamp

The projector lamp has a normal operating time of approximately 1200 to 1500 hours, called the lamp life. During the normal lamp life, the picture will be bright and the colors clear. If the lamp is used beyond the normal lamp life, the picture will become dark and the colors poor. Always replace lamps with new ones. Using an old lamp in the projector could cause a malfunction. When the power is turned on, the LAMP indicator will light up red or a message will be displayed to indicate when it is time to replace the lamp. Consult your dealer.

Lamp/Temperature Status LED Indicators

Lamp Exceed Service Hours — When this LED lights red continuously, it is warning you that the lamp has exceeded 1500 service hours. Replace the projection lamp immediately.

PLEASE CHANGE A NEW LAMP AND RESET THE TIMER— The lamp has been operated for 1400 hours.

PLEASE CHANGE A NEW LAMP, THE POWER WILL TURN OFF AFTER 20 HOURS — The lamp has been operated for 1480 hours, and the power will turn off after 20 more hours.

PLEASE CHANGE A NEW LAMP — The lamp has been operated for more than 1500 hours, and the power will turn off automatically after 10 minutes.

All of these messages will not display for more than 3 minutes, but each message will be displayed whenever you turn on the lamp again.

Lamp is not well attached — When the LED blinks rapidly, it indicates that the lamp is not attached properly.

Temperature is too high — When the projector's internal temperature is too hot to operate safely, the LED blinks slowly for one minute and the lamp goes off automatically.

If the LED light is off, it means that the projector's lamp and temperature are operating under normal conditions.



Caution

The LAMP indicator will light if the lamp becomes too hot. Turn off the power and let the projector cool for 45 minutes. Turn on. If the LAMP indicator still lights up red, please contact your dealer.

Lamp Replacement



WARNING

To reduce the risk of electrical shock, always turn off projector and disconnect power cord before changing lamp.

1. Turn the main power switch off and disconnect the power cord from the outlet.
2. Loosen screw and remove the lamp cover. If the lamp is hot, avoid burns by waiting 45 minutes until lamp has cooled.
3. Loosen two screws designated by arrows below. (It is strongly recommended to use a magnetic-headed screwdriver, if possible. Pull the handle to remove lamp housing. If the screws are not loosened completely, they could damage your fingers. Do not insert your hand into the box after the lamp is removed. If the optical parts inside are touched by hand, it could cause color unevenness, etc.
4. Replace the lamp with the new one, insert into projector, and tighten the screws. Firmly tighten the lamp screws. Loose screws may cause a bad connection, which may result in a malfunction.
5. Re-install the lamp cover and tighten the screw. Do not turn on the power with lamp cover removed. Whenever the lamp has been replaced, reset the total operation time of the lamp. Do not reset if the lamp was not replaced, as this could cause breakage.

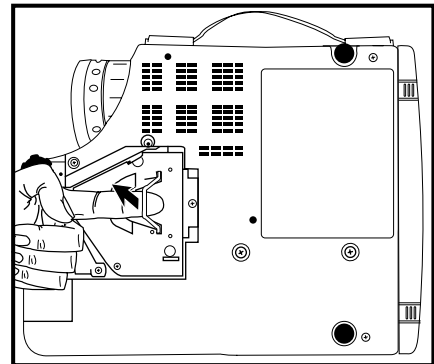
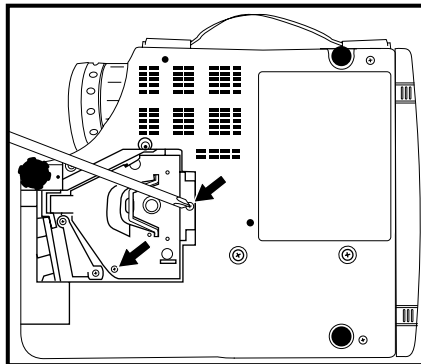
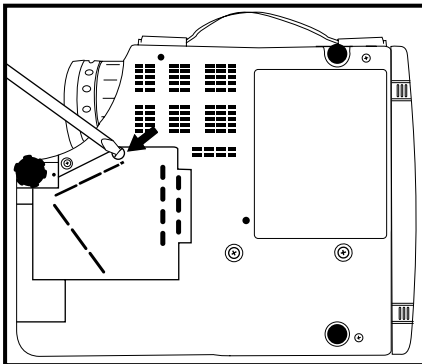

✓ *Note: For maximum lamp life, do not shock, handle or scratch the lamp glass when it is hot. Also, do not use an old or previously used lamp as a replacement lamp.*



Caution

- To reduce the risk of cuts to fingers and/or decreasing image quality by touching the lens, do not insert hand into the empty lamp compartment when the lamp has been removed.
- This lamp contains mercury. Consult your local hazardous waste regulations and dispose of this lamp in a proper manner.
- To reduce the risk of severe burns, allow the projector to cool for at least 45 minutes before replacing the lamp.
- To reduce the risk of cuts to fingers and damage to internal components, use caution when removing lamp glass that has failed and shattered into sharp pieces.

Maintenance



Caution

It is very important to use the correct part when replacing the lamp! If the incorrect lamp is used, the projector could suffer permanent internal damage and require service.

Lamp Ordering

When ordering a lamp, use the part number that references the projector model number.

✓ **Note:** *To determine projector model number, look at the bottom cover label only.*



Projector Model Number	Lamp Part Number
MP7630 MP7730	78-6969-9036-1
MP7630B MP7730B	78-6969-9297-9

Resetting the Lamp Hours

Please do the following within 10 minutes from turning power on if you replace the lamp after 1500 hours.

1. Press the **Menu** button and use **Keystone** buttons to select the **Control** sub-menu. Then press the **Menu** button until the **Lamp Hour** item is selected.

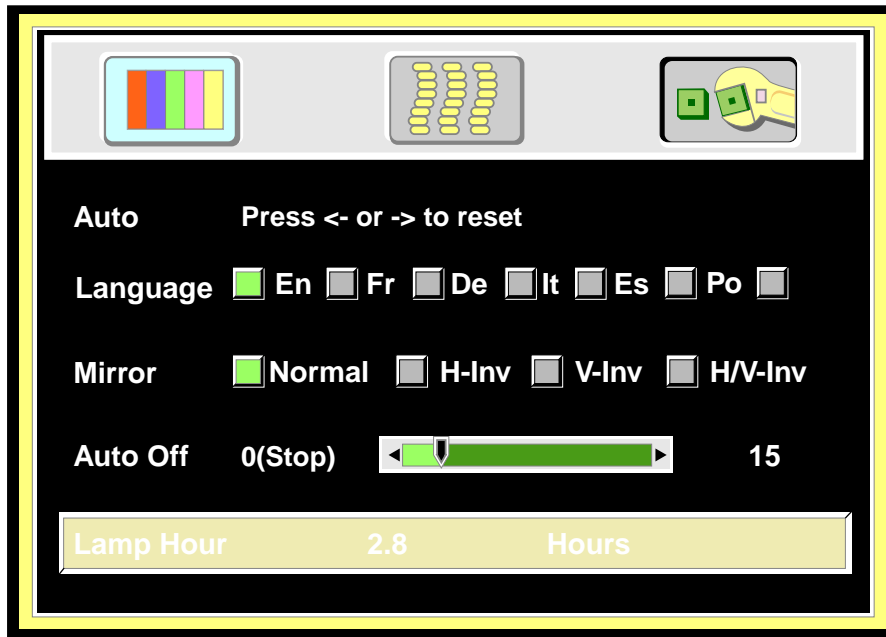

2. Press - **Keystone** + to display the lamp usage on the bottom of the screen. Press again to select "Reset."



3. Press the **Menu** button to reset the time usage.
4. Press the **Auto** button to save the setting and exit the menu system.

Troubleshooting

PROBLEMS	SOLUTIONS
NO POWER	<ul style="list-style-type: none"> ✓ Plug the power cord into the AC inlet. ✓ Plug the power cord into the power inlet. ✓ Wait 2 minutes after turning off the projector before turning it back on.
NO PICTURE	<ul style="list-style-type: none"> ✓ Check that you have selected the proper input source to project. ✓ Ensure that all cables are connected properly. ✓ Adjust the brightness and contrast. ✓ Remove the lens cap.
IMAGE ISN'T SQUARE ON SCREEN	<ul style="list-style-type: none"> ✓ Reposition the unit to improve its angle to the screen. ✓ Is the vertical offset properly corrected using the keystone function?
POOR COLOR	<ul style="list-style-type: none"> ✓ Select the correct video system. ✓ Adjust the brightness, contrast, and saturation.
IMAGE IS BLURRED	<ul style="list-style-type: none"> ✓ Adjust the focus. ✓ Reposition the unit to improve its angle to the screen. ✓ Ensure that the distance between the unit and the screen is within the adjustment range of the lens.
REMOTE CONTROL DOESN'T WORK	<ul style="list-style-type: none"> ✓ Replace the batteries with new ones. ✓ Make sure there are no obstacles between the remote control and the unit. ✓ Operate remote control within 4 meters (13 feet) of the unit. ✓ Make sure nothing blocks the receiver on the control pad.
NO SOUND	<ul style="list-style-type: none"> ✓ Check the audio cable connection from audio input source. ✓ Adjust the audio source. ✓ Press VOLUME (+) button. ✓ Press MUTE button.

Status Indicator Lights and Messages

Message Displayed	Meaning (and Solution, if applicable)
SEARCHING	Projector cannot identify input signal.
INPUT SIGNAL DETECTED, ACTIVATING AUTO IMAGE	Projector has identified input signal.
SYNC IS OUT OF RANGE	The input signal's horizontal frequency exceeds the range of the projector's.
CHANGE THE LAMP AND RESET THE LAMP TIMER	The lamp has been operated for over 1200 hours and needs to be replaced soon.
CHANGE THE LAMP, THE POWER WILL TURN OFF AFTER 20 HOURS.	The lamp has been operated for 1479 hours and the power will shut off after 20 more hours. Replace the lamp as soon as possible.
CHANGE THE LAMP! (blinking, with LED lighting red)	The lamp has been operated for over 1500 hours. Power will automatically shut off in 10 minutes. Replace the lamp immediately.

Service Information

Accessories

Description	Part Number
Power Cord (EU)	DY-0205-1354-4
Power Cord (US)	DY-0205-1356-9
Power Cord (UK)	DY-0205-1355-1
Adapter, PS/2 Mouse	78-8118-8395-4
Adapter, ADB (Apple Desktop Bus) Mouse	78-8118-8397-0
Adapter, Serial Mouse	78-8118-8396-2
General Cable	78-8118-8394-7
VGA Cable	78-8118-3401-5
Mac Adapter (switchable)	78-8118-3308-2
150W Lamp	78-6969-9297-9
Remote Control	78-8118-8398-8
Soft-side Carrying Case	78-6969-9034-6
Lens Cover	78-8118-8399-6

Not Included with Basic Packet

Description	Part Number
NTSC Optional Video Module (RCA with Tuner)	78-6969-9038-7
PAL Optional Video Module (SCART)	78-6969-9104-7
3-Conductor Video/Audio Cable	78-8118-3234-0
Stereo Mini-Jack Cable	78-8118-8290-7
S-Video Cable	78-8118-3538-1
SCART-RCA Adapter	DY-0205-1011-0

Ordering Parts or Getting Information

For product information, product assistance, service information, or to order accessories, please contact 3M Customer Service at the following number:

- In U.S. or Canada: **1-800-328-1371**
- In other locations, contact your 3M Sales office.

The contents of this manual are subject to revision without prior notice.

3M assumes no responsibility for the infringement of special rights of a third party or other rights that may arise out of the information contained in this manual.

Reproduction of this manual in any form without prior permission is strictly prohibited.

3M will replace the manual if any pages are missing or collated incorrectly.

Technical Specifications

✓ *Note: All specifications are subject to change without notice.*

General

Product name	Personal Projector
Model name	MP7630B/MP7730B

Optical

Display system	1-CHIP DMD
Lens	F/Number: F/2.7 – F/3.4 Focal Length: F = 72 – 108 mm (2.8 in. – 4.3 in.)
Lamp	150 W UHP lamp

Speaker

1 watt

Electrical

Power supply	AC100 ~ 240V, 6.5A ~ 2.9A, 50/60 Hz (Automatic)
Power consumption	200 W (Max)

Mechanical

Dimensions	7.7 in. (W) x 2.4 in. (H) x 9.6 in. (D) 198 mm (W) x 62 mm (H) x 245 mm (D)
Operating temperature range	50° ~ 104°F (10° ~ 40°C)
Weight	2.3 kg (5 lbs.)

Input/Output terminal

Video signal input terminal	S VIDEO : Mini DIN 4-pin terminal VIDEO : RCA Jack terminal + BNC AUDIO : RCA Jack terminal
RGB input/output signal terminal	RGB signal : D-sub 15-pin (Female) AUDIO : RCA Jack + BNC
Control terminal	D-sub 9-pin (Male)
Mouse	MD 9-pin (serial/PS2/ADB)

Dimensions

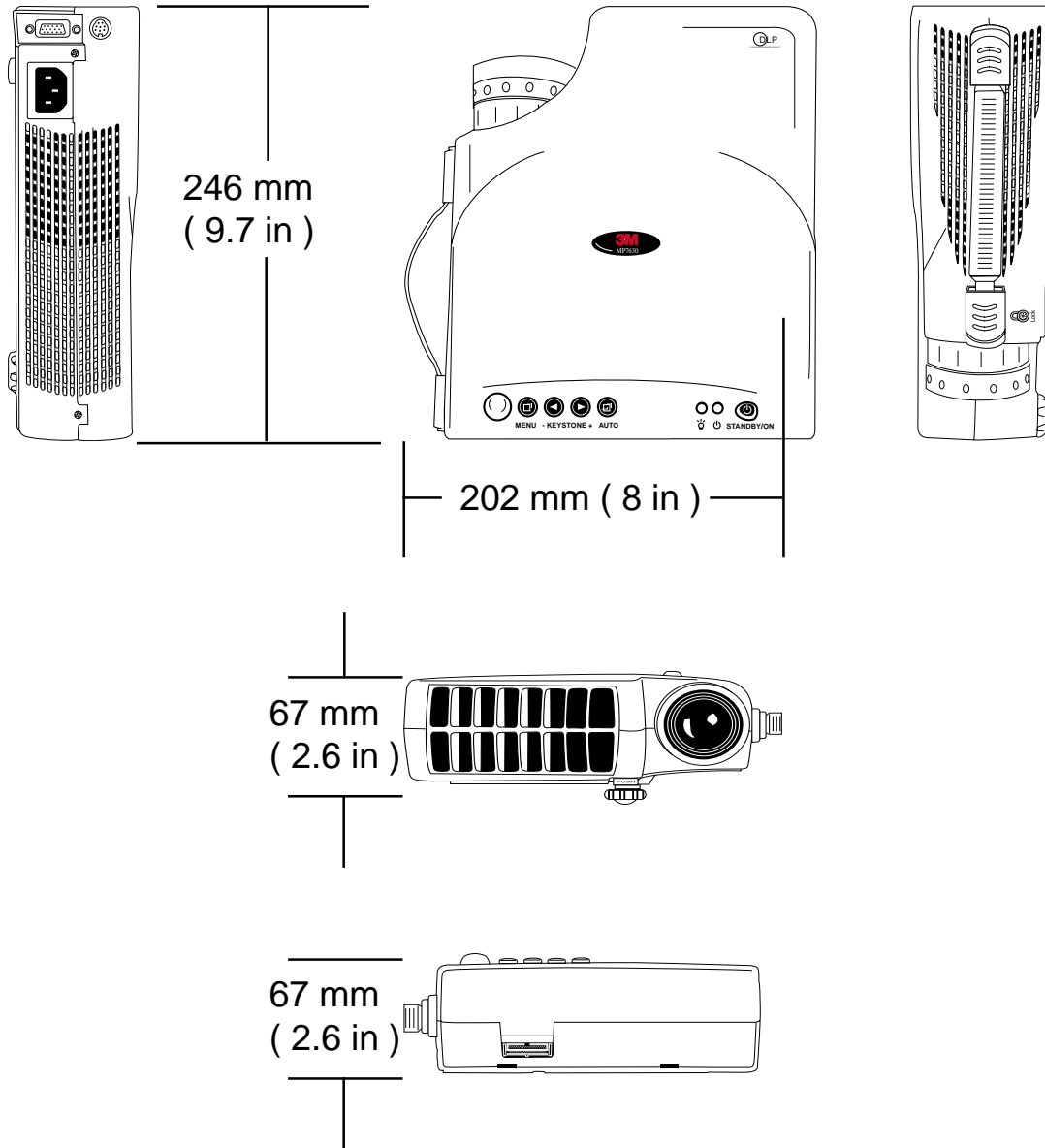

Appendix

Preset Display Resolution Table

Resolution	H Sync (kHz)	V Sync (kHz)	Remark
640 x 350	31.5	70.1	
640 x 400	37.9	85.1	VESA
720 x 400	31.5	70.0	
720 x 400	37.9	85.1	VESA
640 x 480	31.5	60.0	VESA
640 x 480	37.9	72.8	VESA
640 x 480	35	66.7	Macintosh
640 x 480	43.3	85.0	VESA
800 x 600	35.2	56.3	VESA
800 x 600	37.9	60.3	VESA
800 x 600	46.9	75.0	VESA
800 x 600	48.1	72.2	VESA
800 x 600	53.7	85.1	VESA
832 x 624	49.7	74.5	Macintosh
1024 x 768	48.4	60.0	VESA
1024 x 768	56.5	70.1	VESA
1024 x 768	60.0	75.0	VESA
1024 x 768	68.7	85.0	VESA
1280 x 1024	64.0	60.0	VESA

Appendix

Nationality Codes

API TV System Code Definition

NTSC Tuner Box

	Area	Channel		
NTSC	USA	1 (STD)	2 (HRC)	2 (IRC)
NTSC	Taiwan	1		
NTSC	Canada	1		
NTSC	Chile	1		
NTSC	Columbia	1		
NTSC	Mexico	1		
NTSC	Peru	1		
NTSC	South Korea	1		
NTSC	Venezuela	1		
NTSC	Japan	4		
PAL-N	Argentina	5		
PAL-N	Paraguay	5		
PAL-N	Uruguay	5		
PAL-M	Brazil	6		

Important Notice

All statements, technical information, and recommendations related to 3M's products are based on information believed to be reliable, but the accuracy or completeness is not guaranteed. Before using this product, you must evaluate it and determine if it is suitable for your intended application. You assume all risks and liability associated with such use. Any statements related to the product which are not contained in 3M's current publications, or any contrary statements contained on your purchase order shall have no force or effect unless expressly set forth in a written agreement signed by an authorized officer of 3M.

Warranty and Limited Remedy. This product will be free from defects in material and manufacture for a period of two years from the date of purchase. Exclusion to Warranty: The lamps are considered a consumable item and are warranted for 90 days or 180 hours, whichever occurs first. **3M MAKES NO OTHER WARRANTIES, INCLUDING BUT NOT LIMITED TO, ANY IMPLIED WARRANTY OF MERCHANTABILITY OR FITNESS FOR A PARTICULAR PURPOSE.** If this product is defective within the warranty period stated above, your exclusive remedy shall be, at 3M's option, to replace or repair the 3M product or refund the purchase price of the 3M product.

Limitation of Liability. Except where prohibited by law, 3M will not be liable for any loss or damage arising from this 3M product, whether direct, indirect, special, incidental or consequential regardless of the legal theory asserted.

Let us help you make the most of your next presentation. We offer everything from presentation supplies to tips for better meetings. And we're the only transparency manufacturer that offers a recycling program for your used transparencies. For late-breaking news, handy reference and free product samples, call us toll-free in the continental United States and Canada, 24 hours a day, or visit our Internet Website.

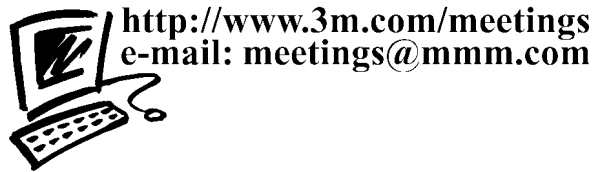
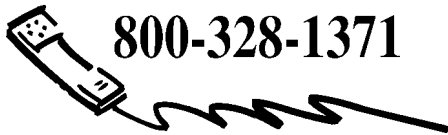

3M Austin Center
Building A145-5N-01
6801 River Place Blvd.
Austin, TX 78726-9000

3M Canada
P.O. Box 5757
London, Ontario
N6A 4T1

3M Mexico, S.A. de C.V.
Apartado Postal 14-139
Mexico, D.F. 07000
Mexico

3M Europe
Boulevard de l'Oise
95006 Cergy Pontoise Cedex
France

Litho in USA
Copyright © 2001 3M IPC.
All Rights Reserved
78-6970-9063-3 Rev. A

