

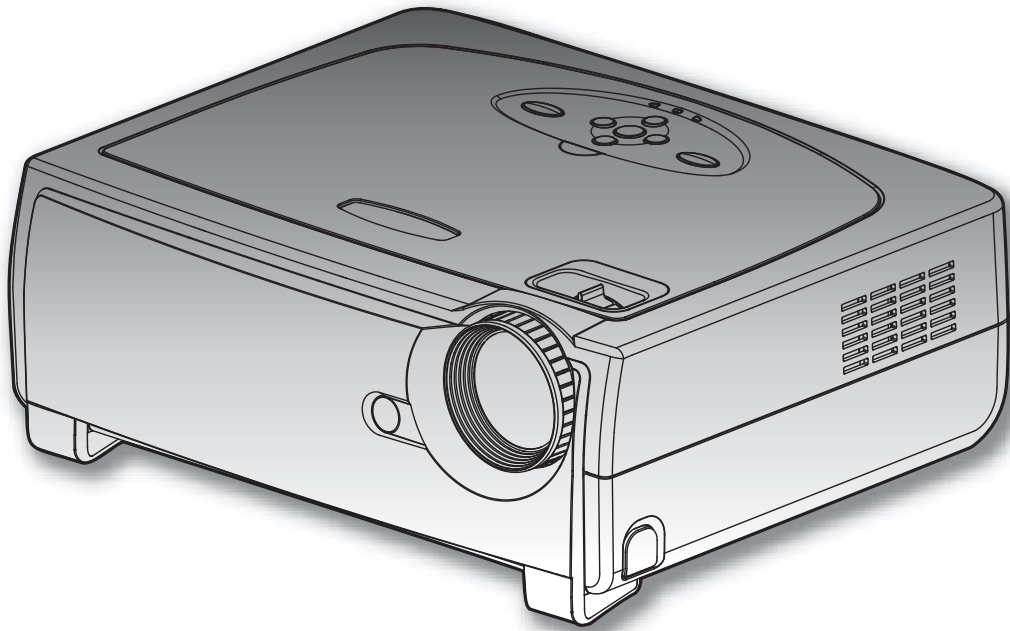

# Digital Projector DX70i

## Operator's Guide



### **Important Note**

Before using this product, please read the "Product Safety Guide" and related manuals to ensure the proper use of this product. After reading them, store them in a safe place for future reference.

3M Projection Systems  
6801 River Place Boulevard  
Austin, Texas 78726-9000  
[www.3m.com/meetings](http://www.3m.com/meetings)

Digital Projector Operator's Guide  
© 3M 2008. All Rights Reserved  
78-6971-1447-4

**Contact 3M**

In the event of missing and/or damaged equipment, or technical questions, the following information can help in the completion of the installation.

Customer Service – 1-800-328-1371 (US)

The 3M logo, and 3M are trademarks of the 3M Company.

**Important Notice**





All statements, technical information, and recommendations related to 3M's products are based on information believed to be reliable, but the accuracy or completeness is not guaranteed. Before using this product or implementation, you must evaluate them and determine if they are suitable for your intended application or situation. You assume all risks and liability associated with such use or implementation. Any statements related to the product which are not contained in 3M's current publications, or any contrary statements contained on your purchase order shall have no force or effect unless expressly agreed upon, in writing, by an authorized officer of 3M.

All rights reserved. No part of this book covered by the copyrights hereon may be reproduced or copied in any form or by any means-graphic, electronic, or mechanical, including photocopying, taping or information storage and retrieval systems-without written permission of 3M.

<b>Table of Contents</b> .....	1
<b>Usage Notice</b> .....	2
Precautions .....	2
Important Note .....	3
<b>Introduction</b> .....	4
Product Features .....	4
Package Overview .....	5
Product Overview .....	6
Main Unit .....	6
Control Panel .....	7
Connection Ports .....	8
Remote Control with Mouse Function and Laser Pointer .....	9
<b>Installation</b> .....	10
Connecting the Projector .....	10
Connect the Computer/Notebook .....	10
Connect the Video .....	11
Powering On/Off the Projector .....	12
Powering On the Projector .....	12
Powering Off the projector .....	13
LED Indicator .....	13
Adjusting the Projected Image .....	14
Adjusting the Projector Image Height .....	14
Adjusting the Projector Zoom / Focus .....	15
Adjusting Projected Image Size .....	15
<b>User Controls</b> .....	16
Control Panel & Remote Control .....	16
On-Screen Display Menus .....	19
How to Operate .....	19
Menu Tree .....	20
Image-I .....	21
Image-II .....	23
Colour .....	25
Language .....	27
Management .....	28
Lamp & Power .....	36
<b>Appendices</b> .....	37
Troubleshooting .....	37
Replacing the Lamp .....	41
Compatibility Modes .....	42
Ceiling Mount Installation .....	43
RS232 Protocol Function List .....	44
Regulation & Safety notices .....	47

## Precautions

*Follow all warnings, precautions and maintenance as recommended in this user's guide to maximize the life of your unit.*

-  Warning- Do not look into the projector's lens when the lamp is on. The bright light may hurt your eyes.
-  Warning- To reduce the risk of injury to the eyes, do not look directly into the laser light on the remote control and do not point the laser light into anyone eyes. This remote control is equipped with a Class II laser that emits radiation.
-  Warning- To reduce the risk of fire or electric shock, do not expose this product to rain or moisture.
-  Warning- Please do not open or disassemble the product as this may cause electric shock.
-  Warning- When changing the lamp, please allow unit to cool down, and follow all changing instructions.

### *Do:*

- ❖ Turn off the product before cleaning.
- ❖ Use a soft cloth moistened with mild detergent to clean the display housing.
- ❖ Disconnect the power plug from AC outlet if the product is not being used for a long period of time.

### *Don't:*

- ❖ Block the slots and openings on the unit provided for ventilation.
- ❖ Use abrasive cleaners, waxes or solvents to clean the unit.

- ❖ Use under the following conditions:
  - In extremely hot, cold or humid environments.
  - In areas susceptible to excessive dust and dirt.
  - Near any appliance that generates a strong magnetic field.
  - In direct sunlight.

## Important Note

1. This product will detect the life of the lamp itself. Please be sure to change the lamp when it shows warning messages.
2. Reset the “Lamp Reset” function from the On Screen Display “Lamp Setting” menu after replacing the lamp module (refer to page 36).
3. When switching the projector off, please ensure the projector completes its cooling cycle before disconnecting power.
4. Turn on the projector first and then the signal sources.
5. Do not use lens cap when projector is in operation.
6. When the lamp reaches the end of its life, it will burn out and may make a loud popping sound. If this happens, the projector will not turn back on until the lamp module has been replaced. To replace the lamp, follow the procedures listed under “Replacing the Lamp”. (see page 41)

## Product Features

*This product is a XGA single chip 0.7" Darkchip3 DLP® projector. Outstanding features include:*

- ◆ True XGA, 1024 x 768 addressable pixels
- ◆ Texas Instruments Single chip DLP® Technology
- ◆ NTSC/NTSC4.43/PAL/PAL-M/PAL-N/SECAM and HDTV compatible (480i/p, 576i/p, 720p, 1080i)
- ◆ Multi-Auto functions: Auto detection, Automatic saving of user adjustments
- ◆ Full function IR remote control with laser pointer
- ◆ User friendly multilingual on screen menu
- ◆ Advanced digital keystone correction and high quality full screen image re-scaling
- ◆ User friendly control panel
- ◆ Two built-in speakers with 2 Watt amplifier
- ◆ Multiple for Audio inputs
- ◆ Computer Compatibility: UXGA, SXGA+, SXGA compression and SVGA, VGA re-sizing
- ◆ Mac compatible
- ◆ DVI support (HDCP compliant)
- ◆ Support Network function (LAN/RS232)

## Package Overview

*This projector comes with all the items shown below. Check to make sure your unit is complete. Contact your dealer immediately if anything is missing.*

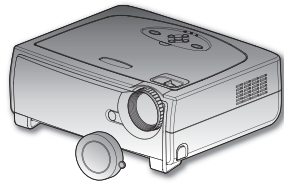

Projector with lens cap

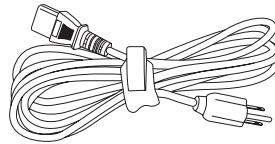

Power Cord

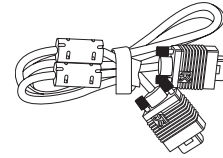

VGA Cable 1.8m

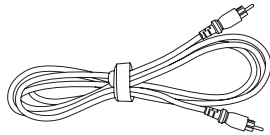

Composite Video Cable  
1.8m

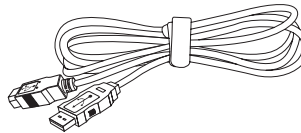

USB Cable 1.8m

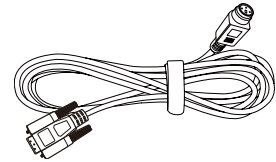

RS232 Cable 1.8m

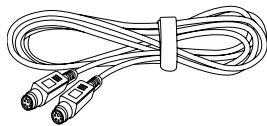

S-Video Cable 1.8m

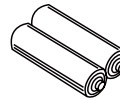

2 x AAA Batteries



Wireless Remote  
Controller

### NOTE

- Due to the difference in applications for each country, some regions may have different accessories.

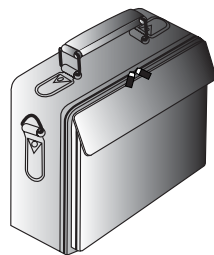

Carrying Case

### Documents :

- Operator's Guide
- Quick Start Card
- Warranty Card

## Product Overview

### Main Unit

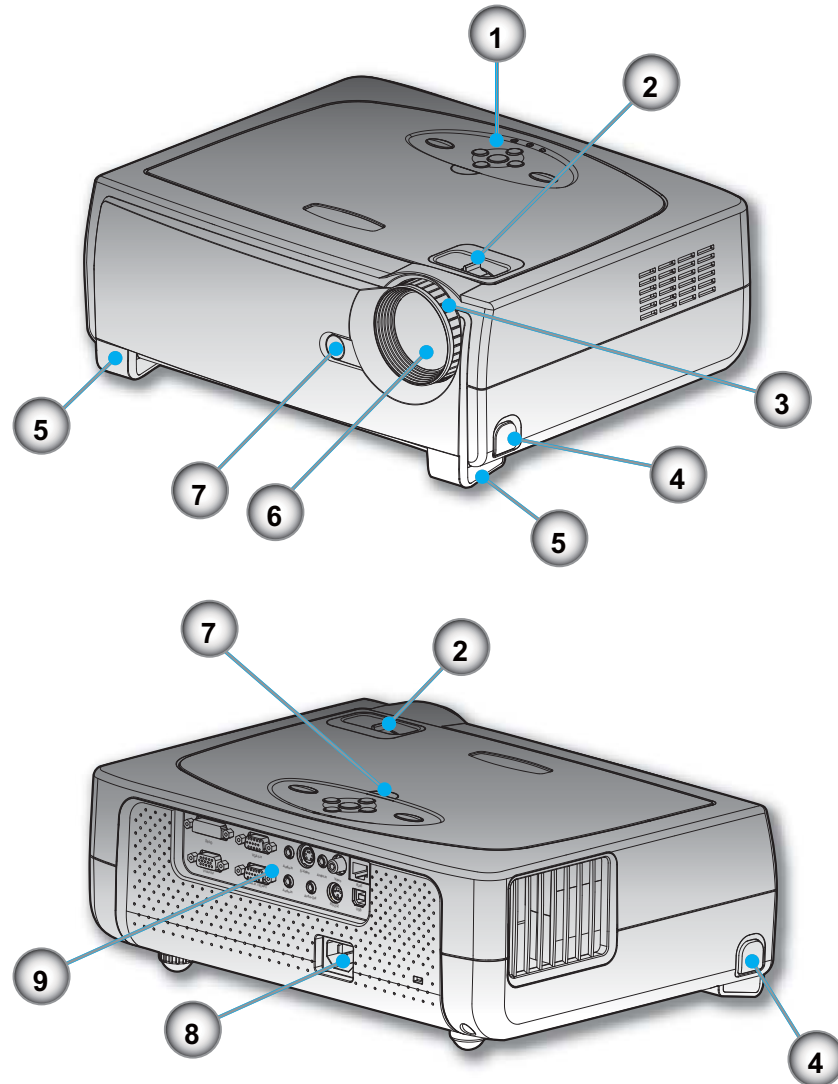

1. Control Panel
2. Zoom Lever
3. Focus Ring
4. Elevator Button (one on each side)
5. Elevator Foot (one on each side)
6. Zoom Lens
7. IR Receivers
8. Power Socket
9. Connection Ports



## Control Panel

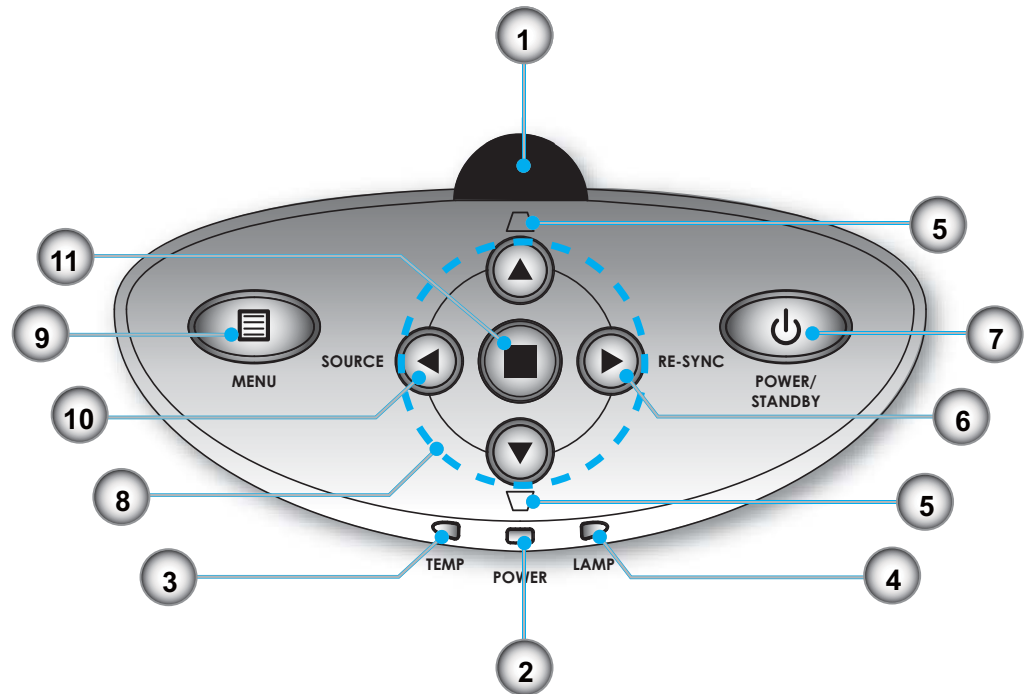

1. IR Receiver
2. Power/Standby LED
3. Temp Indicator LED
4. Lamp Indicator LED
5. Keystone +/-
6. Re-Sync
7. Power/Standby
8. Four Directional Select Keys
9. Menu (On/Off)
10. Source Select
11. Enter

## Connection Ports

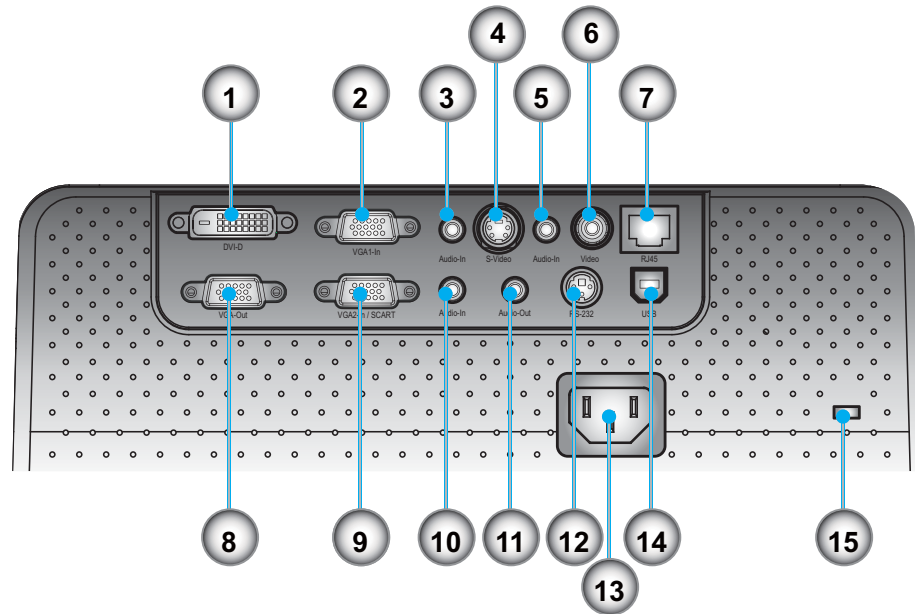

1. DVI-D Input Connector (PC Digital/HDTV/HDCP Input)
2. VGA1-In Connector (PC Analog signal/HD/Component Video Input)
3. Audio Input Connector (for DVI-D or VGA1-In)
4. S-Video Input Connector
5. Audio Input Connector (for S-Video or Composite)
6. Composite Video Input Connector
7. Networking Connector RJ45
8. Monitor Loop-through Output Connector
9. VGA2-In SCART Connector (PC Analog signal/SCART RGB/HD/Component Video Input)
10. Audio Input Connector (for VGA2-In SCART)
11. Audio Output Connector
12. RS232 Connector
13. Power Socket
14. USB Connector (connect to PC for Remote Mouse function)
15. Kensington™ Lock Port

## Remote Control with Mouse Function and Laser Pointer

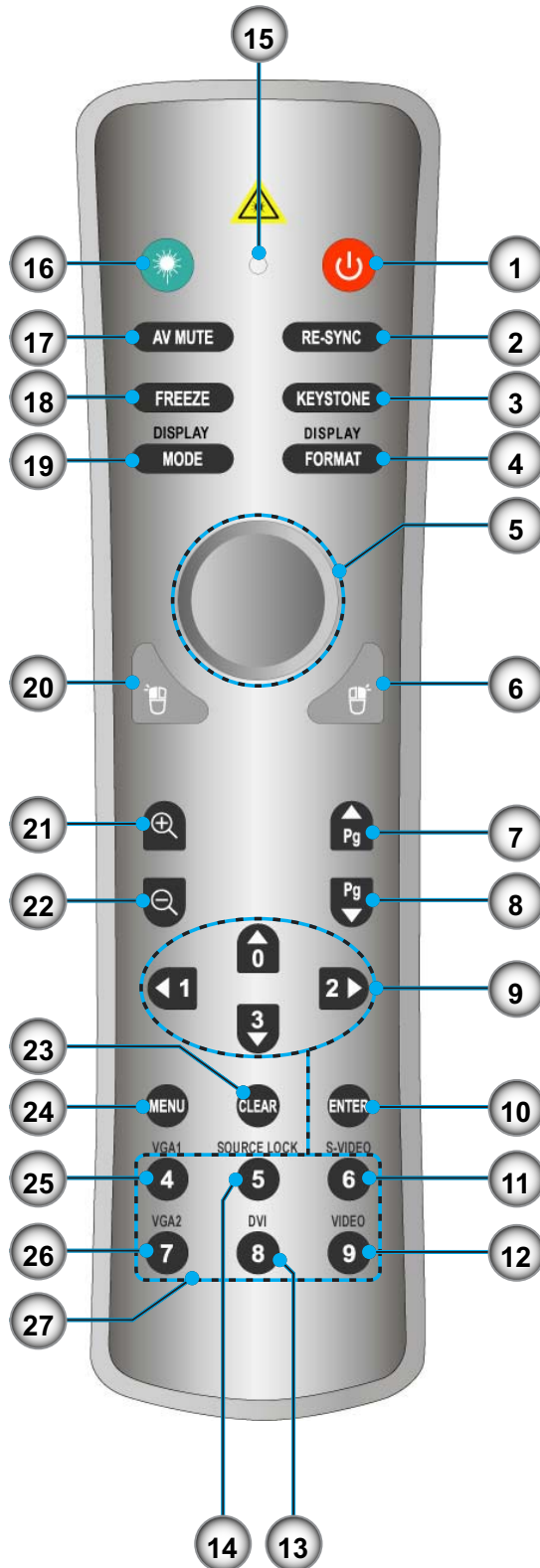
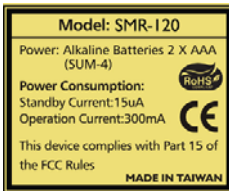

1. Power
2. Re-Sync
3. Keystone Correction
4. Display Format
5. Mouse
6. Mouse Right Click
7. Page Up
8. Page Down
9. Four Directional Select Keys
10. Enter
11. S-Video Source
12. Composite Video Source
13. DVI Source
14. Source Lock
15. Button LED
16. Laser Button
17. AV Mute
18. Freeze
19. Display Mode
20. Mouse Left Click
21. Zoom In
22. Zoom Out
23. Clear
24. Menu
25. VGA1 Source
26. VGA2 Source
27. Number Buttons

# Connecting the Projector

## Connect the Computer/Notebook

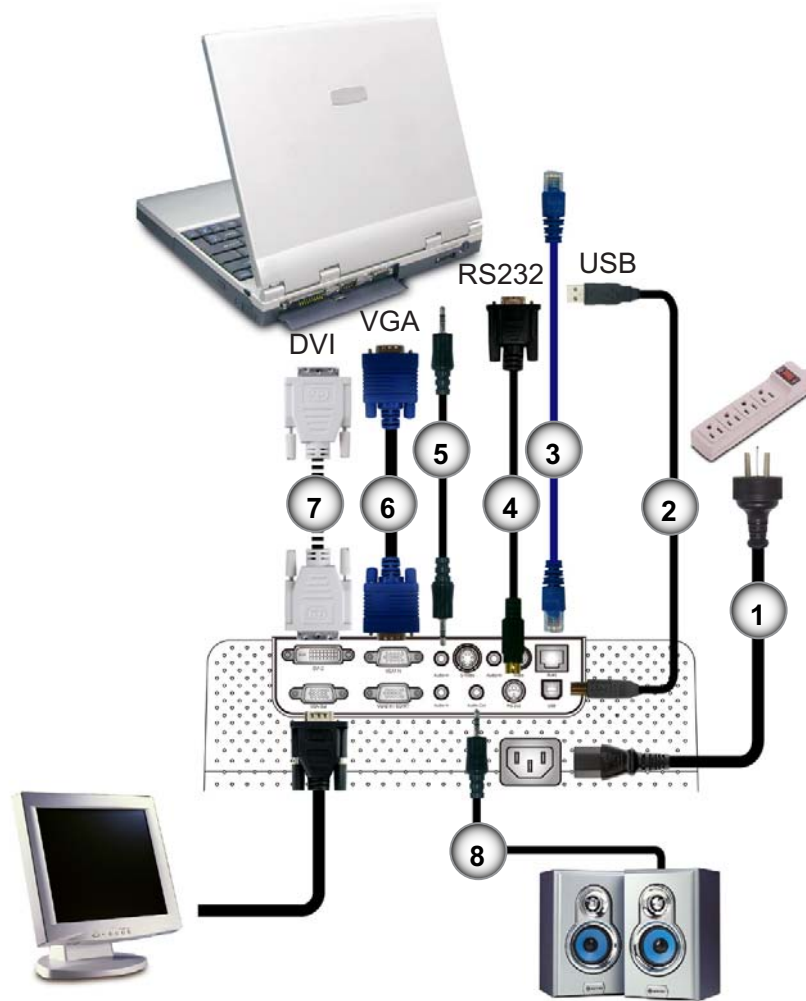

**NOTE**

- Due to the difference in applications for each country, some regions may have different accessories.

Audio Output  
(For Active Speakers)

- |        |   |
|--------|---|
| 1..... | Power Cord                              |
| 2..... | USB Cable                               |
| 3..... | Network Cable (optional accessory)      |
| 4..... | RS232 Cable                             |
| 5..... | Audio Input Cable (optional accessory)  |
| 6..... | VGA Cable                               |
| 7..... | DVI to DVI Cable (optional accessory)   |
| 8..... | Audio Output Cable (optional accessory) |

### Connect the Video

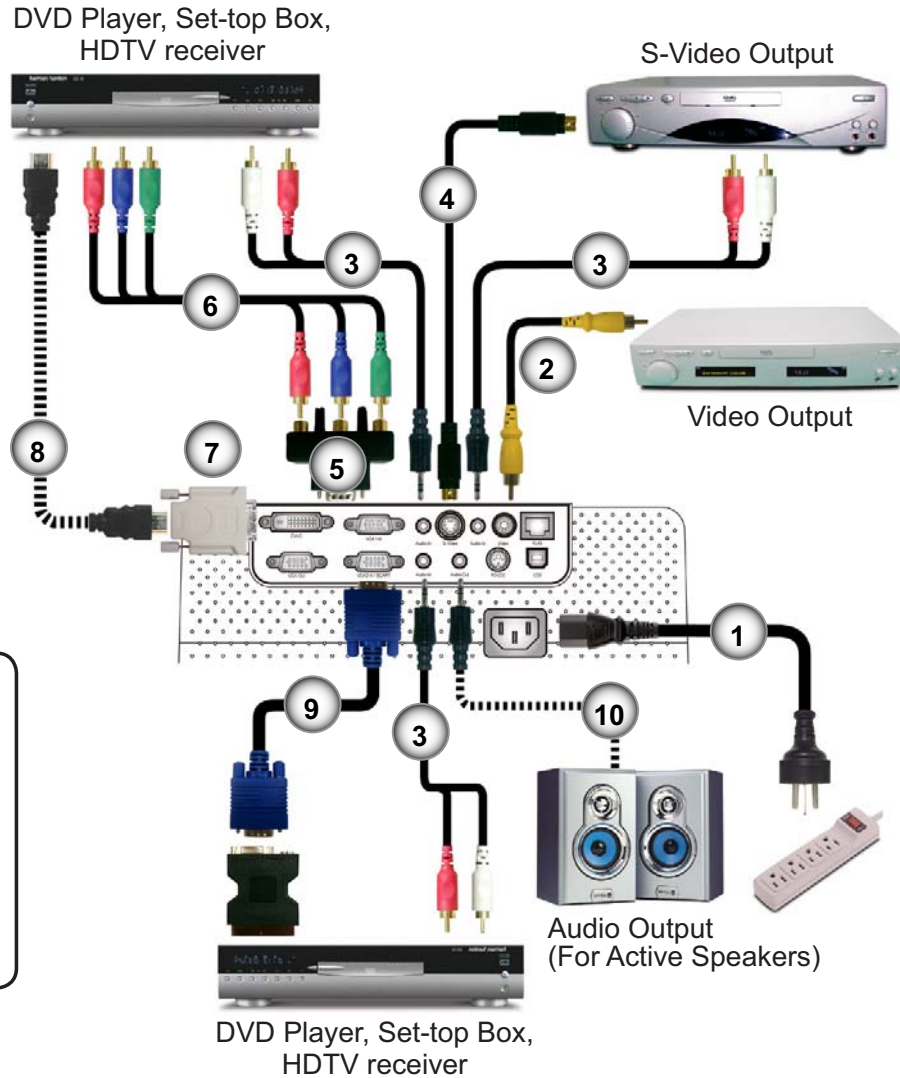

**NOTE**

- Due to the difference in applications for each country, some regions may have different accessories.

- 1.....Power Cord
- 2..... Composite Video Cable
- 3..... Audio Input Cable (optional accessory)
- 4.....S-Video Cable
- 5..... VGA to 3 RCA Component/HDTV Adapter (optional accessory)
- 6.....RCA Component Cable for YPbPr (optional accessory)
- 7..... HDMI to DVI Adapter (optional accessory)
- 8..... HDMI Cable (optional accessory)
- 9..... VGA Cable
- 10..... Audio Output Cable (optional accessory)

# Powering On/Off the Projector

## Powering On the Projector

1. Remove the lens cap. ❶
2. Ensure that the power cord and signal cable are securely connected. The Power LED will turn red.
3. Turn on the lamp by pressing “Power/Standby” button on the control panel. ❷ And the Power LED will turn green.
4. Turn on your source (computer, notebook, video player, etc.). The projector will detect your source automatically within “Management” menu; check that “Source Lock” has been set to “Lock”.

Test Pattern



❖ If the screen displays “No Signal”, please make sure the signal cables are securely connected.

❖ To access the built-in test pattern, please press the “AV Mute” button, then up arrow.

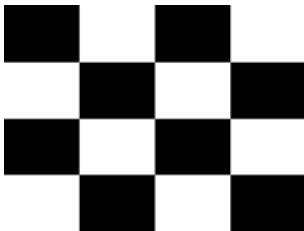

❖ If you connect multiple sources at the same time, use the “Source” button on the control panel or direct source key on remote control to switch.

**NOTE**  
 • Turn on the projector first and then the signal sources.

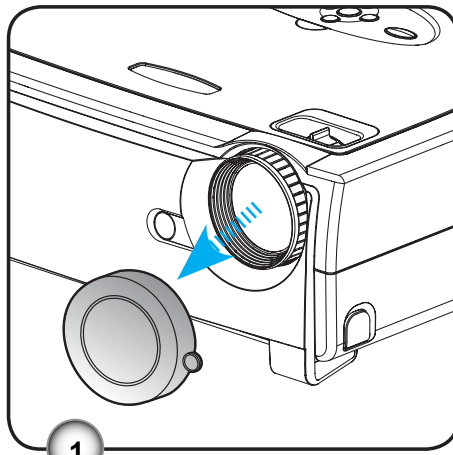

Lens Cap

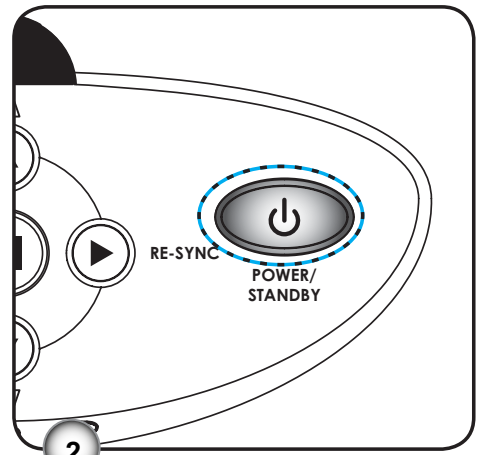

Power/Standby

## Powering Off the Projector

1. Press the “Power/Standby” button to turn off the projector lamp; you will see a message

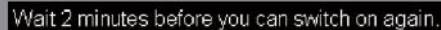

Wait 2 minutes before you can switch on again.



Press "Power" key again to confirm.

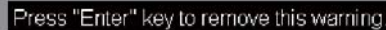

Press "Enter" key to remove this warning.

displayed on the projector's screen. Press the “Power/Standby” button again to confirm.

2. The cooling fans continue to operate for about 2 minutes for cooling cycle and the Power LED will flash red. When the Power LED stops flashing, the projector has entered standby mode.

Once in standby mode, simply press “Power/Standby” button to restart the projector.

3. Disconnect the power cord from the electrical outlet and the projector.
4. Do not turn on the projector immediately following a power off procedure.

## LED Indicator

- ❖ When the “TEMP” indicator turns red, it indicates the projector has overheated. The projector will automatically shut itself down.
- ❖ When the “LAMP” indicator turns red, it indicates a problem with the lamp. Turn off the projector and disconnect the power cord from the electrical outlet, then contact your local dealer or our service center.
- ❖ When the “LAMP” indicator flashes red, it indicates the fan has failed. Stop using the projector and disconnect the power cord from the electrical outlet, then contact your local dealer or our service center.

## Adjusting the Projected Image

### Adjusting the Projector Image Height

*The projector is equipped with elevator feet for adjusting the image height.*

To raise the image:

1. Press the elevator buttons **1**.
2. Raise the image to the desired height angle **2**, then release the button to lock the elevator feet into position.
3. Use screw in feet **3** to fine-tune the display angle.

To lower the image:

1. Press the elevator buttons.
2. Lower the image, then release the button to lock the elevator feet into position.
3. Use screw in foot **3** to fine-tune the display angle.

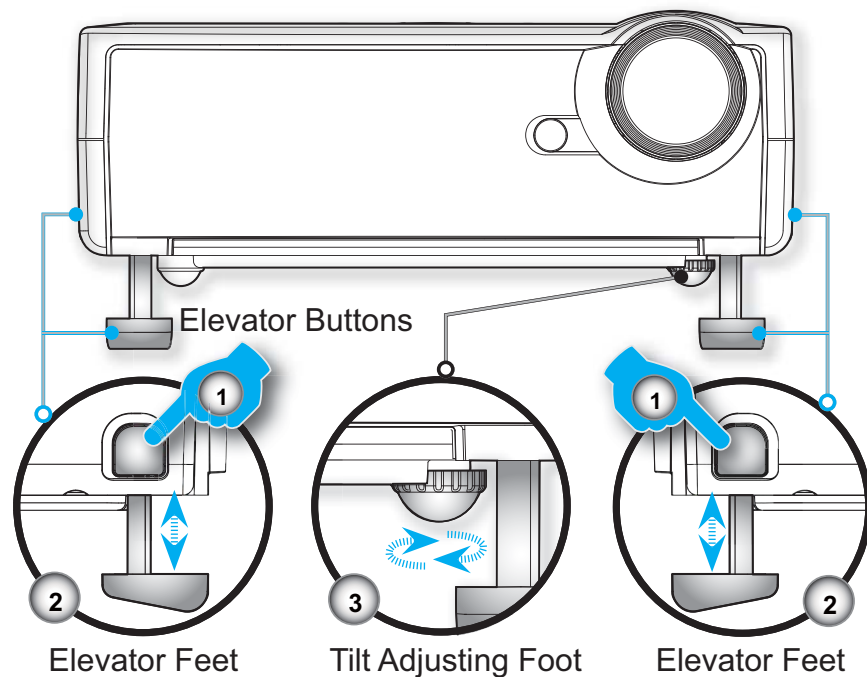



## Adjusting the Projector Zoom / Focus

You may turn the zoom lever to zoom in or out. To focus the image, rotate the focus ring until the image is clear. The projector will focus at distances from 3.3 to 40.0 feet (1.0 to 12.2 meters).

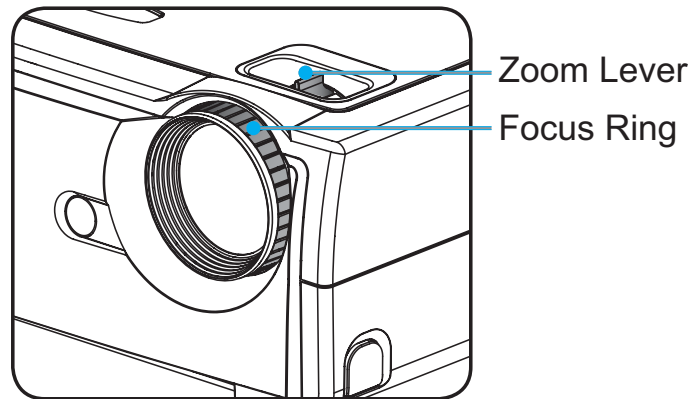

## Adjusting Projection Image Size

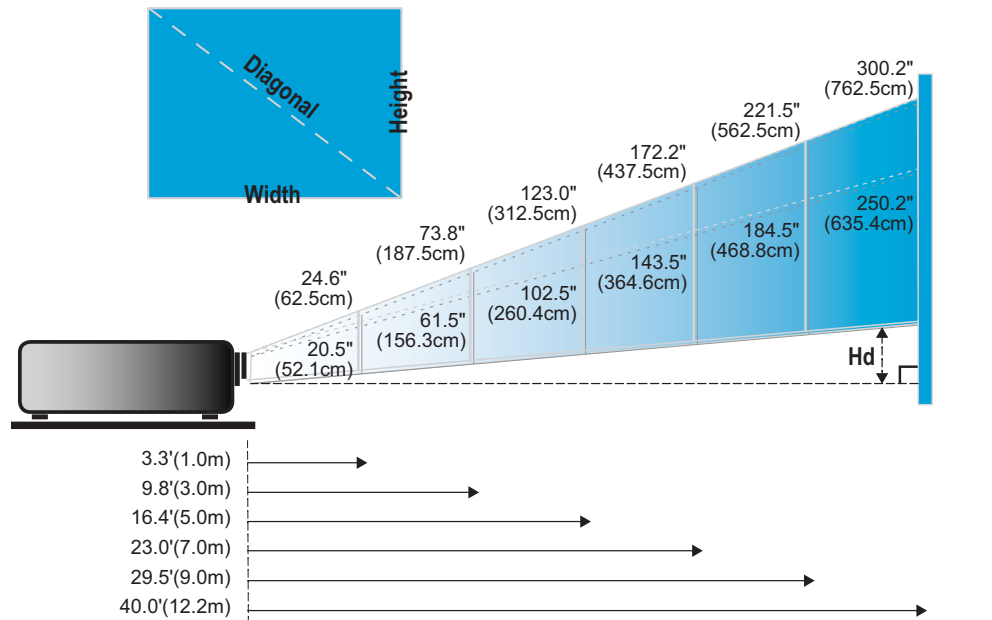

Screen (Diagonal)	Max.	24.6"(62.5cm)	73.8"(187.5cm)	123.0"(312.5cm)	172.2"(437.5cm)	221.5"(562.5cm)	300.2"(762.5cm)
	Min.	20.5"(52.1cm)	61.5"(156.3cm)	102.5"(260.4cm)	143.5"(364.6cm)	184.5"(468.8cm)	250.2"(635.4cm)
Screen Size	Max. (WxH)	19.68" x 14.76" 50.0 x 37.5cm	59.04" x 44.28" 150.0 x 112.5cm	98.4" x 73.8" 250.0 x 187.5cm	137.76" x 103.32" 350.0 x 262.5cm	177.20" x 132.90" 450.0 x 337.5cm	240.16" x 180.12" 610.0 x 457.5cm
	Min. (WxH)	16.40" x 12.30" 41.7 x 31.3cm	49.20" x 36.90" 125.0 x 93.8cm	82.0" x 61.5" 208.3 x 156.2cm	114.8" x 86.1" 291.7 x 218.8cm	147.6" x 110.7" 375.0 x 281.3cm	200.16" x 150.12" 508.3 x 381.2cm
Hd	Max.	2.21" (5.6cm)	6.64" (16.9cm)	11.07" (28.1cm)	15.50" (39.4cm)	19.94" (50.6cm)	27.02" (68.6cm)
	Min.	1.85" (4.7cm)	5.54" (14.1cm)	9.23" (23.4cm)	12.92" (32.8cm)	16.61" (42.2cm)	22.52" (57.2cm)
Distance		<b>3.3' (1.0m)</b>	<b>9.8' (3.0m)</b>	<b>16.4' (5.0m)</b>	<b>23.0' (7.0m)</b>	<b>29.5' (9.0m)</b>	<b>40.0' (12.2m)</b>
❖ This graph is for user's reference only.							

## Control Panel & Remote Control







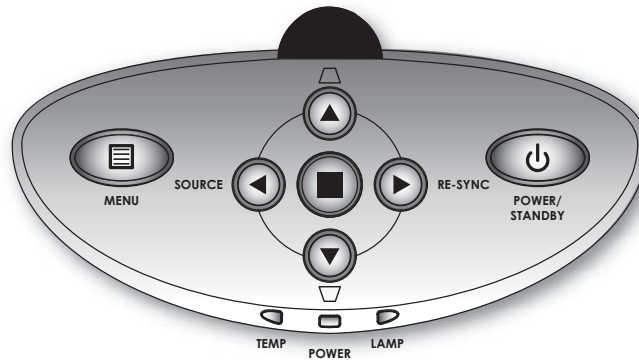

There are two ways for you to control the functions:  
Remote Control and Control Panel.

---

### Using the Control Panel

---



 <b>Power/ Standby</b>	Refer to the “Power On/Off the Projector” section on pages 12-13.
 <b>Source</b>	Press “Source” to select an input signal.
<b>Menu</b>	Turns the menu On or Off.
<b>Four Directional Select Keys</b>	Use     to navigate through the menus.
 <b>Enter</b>	Confirm your item selection.
 <b>Keystone</b>	Adjusts image distortion caused by tilting the projector ( $\pm 16$ degrees).
 <b>Re-Sync</b>	Automatically synchronizes the projector to the input source.

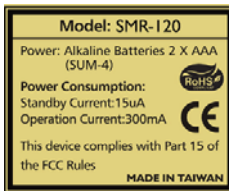

## Using the Remote Control

**Power** Refer to the “Power On/Off the Projector” section on pages 12-13.

**Re-Sync** Automatically synchronizes the projector to the input source.

**Keystone** Adjusts image distortion caused by tilting the projector ( $\pm 16$  degrees).

**Display Format** Display the “Aspect Ratio” section of the on-screen display menu to select the desired aspect ratio.

**Laser Button** Aim the remote at the viewing screen, press and hold this button to activate the laser pointer.

**AV Mute** Momentarily turns off the audio and video. Press this button again to unlock.

**Freeze** Press “Freeze” to pause the screen image. Press this button again to unlock.

**Display Mode** Select the display mode from PC, Photo, Video, sRGB and User.

**Mouse Control** Use this button to navigate the mouse on the page.

**Mouse Right Click** Mouse right click.

**Mouse Left Click** Mouse left click.

**Page Up** Use this button to page up.

**Page Down** Use this button to page down.

**Zoom In** Zoom in to magnify the image.

**Zoom Out** Zoom out to reduce the image.

**Four Directional Select Keys** Use **▲ ▼ ◀ ▶** to navigate through the menus.

**Menu** Display or exits the on-screen display menus for projector.

---

<b>Clear</b>	Clear your selection.
<b>Enter</b>	Confirm your item selection.
<b>Source Lock</b>	Select auto detection all connector ports or lock current connector port. (see page 28 for more)
<b>Video</b>	Choose composite video source.
<b>S-Video</b>	Choose S-Video source.
<b>VGA1</b>	Choose primary VGA-In source.
<b>VGA2</b>	Choose secondary VGA-In or SCART source.
<b>DVI</b>	Choose DVI-D source.

---

## On Screen Display Menus

*The Projector has multilingual On Screen Display menus that allow you to make image adjustments and change a variety of settings. The projector will automatically detect the source.*

### How to Operate

1. To open the OSD menu, press “Menu” on the Remote Control or Control Panel.
2. When OSD is displayed, use ◀▶ keys to select any item in the main menu. While making a selection on a particular page, press ▼ key to enter sub menu.
3. Use ▲▼ keys to select the desired item and adjust the settings by ◀▶ key.
4. Select the next item to be adjusted in the sub menu and adjust as described above.
5. Press “Menu” to confirm, and the screen will return to the main menu.
6. To exit, press “Menu” again. The OSD menu will close and the projector will automatically save the new settings.

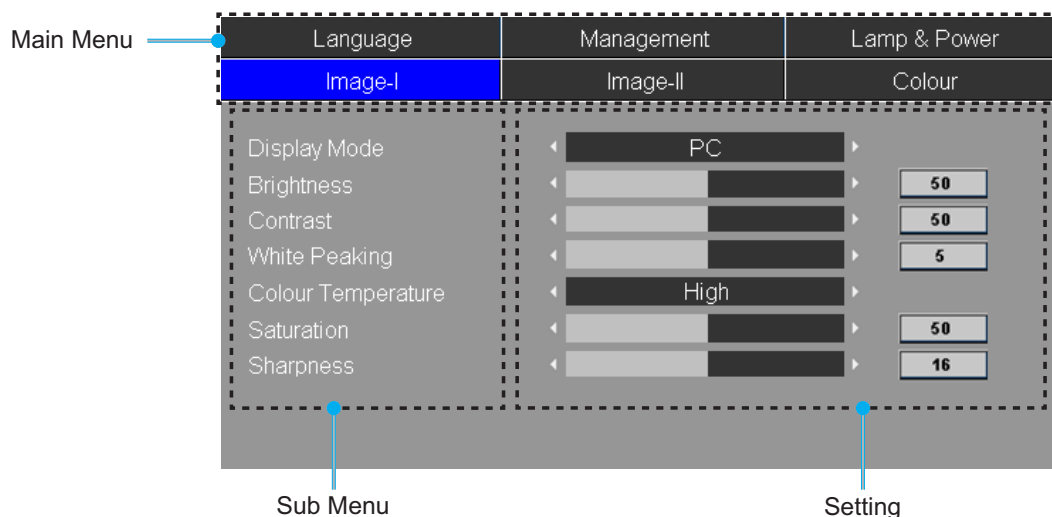

# Menu Tree

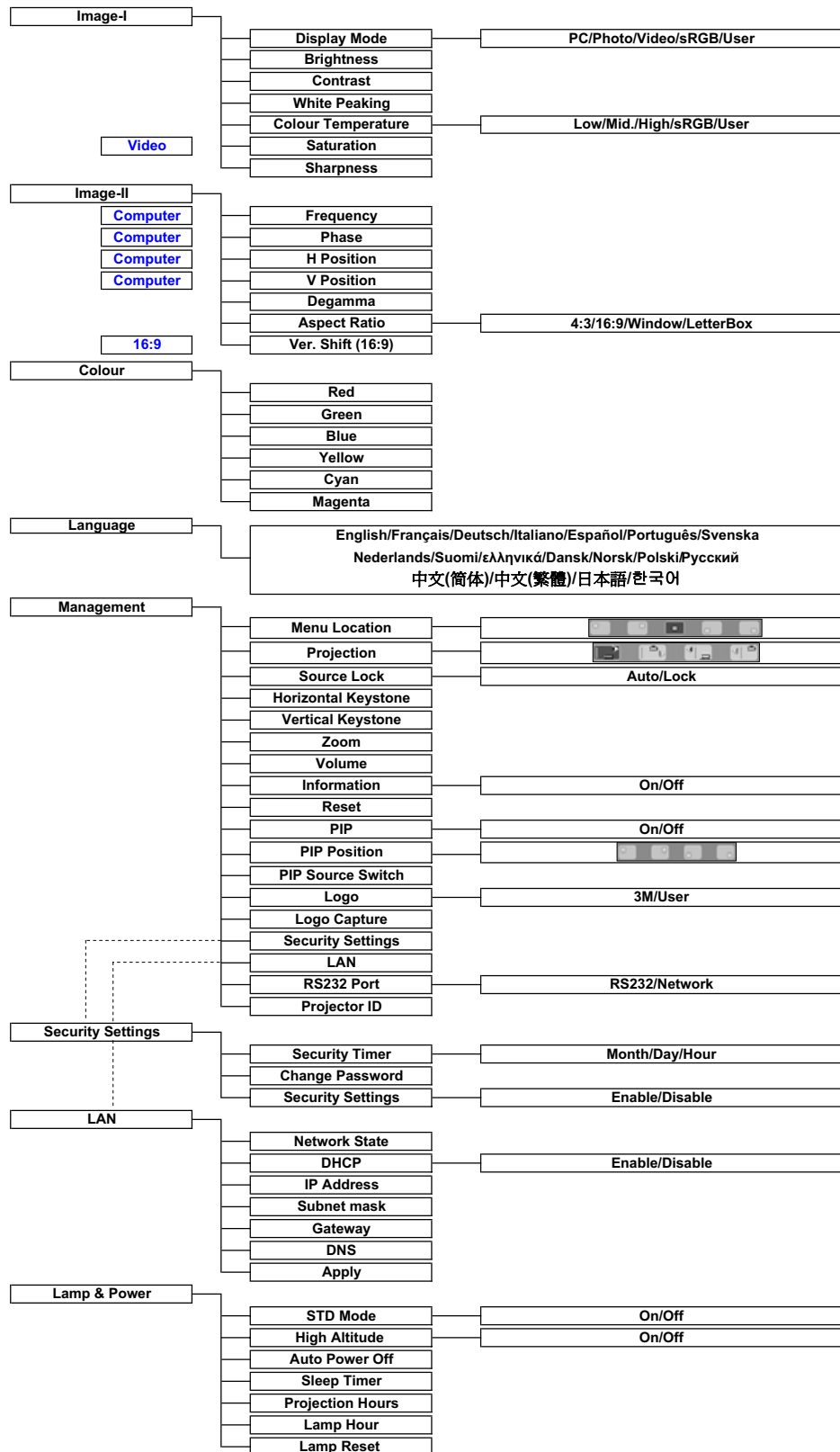

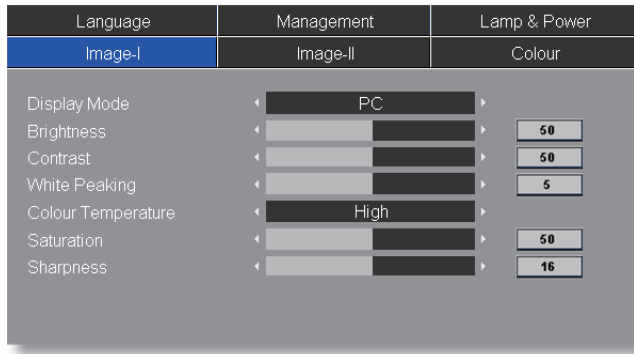

## *Image-I*

### Display Mode

There are many factory presets optimized for various types of images.

- ▶ PC: For computer or notebook. (brightest image)
- ▶ Photo: For optimum colour at high brightness.
- ▶ Video: For playing video in a bright environment.
- ▶ sRGB: For standard PC colour. (best colour reproduction)
- ▶ User: Memorize user's settings.

### Brightness

Adjust the brightness of the image.

- ▶ Press the ◀ to darken image.
- ▶ Press the ▶ to lighten the image.

### Contrast

The contrast controls the degree of difference between the lightest and darkest parts of the picture. Adjusting the contrast changes the amount of black and white in the image.

- ▶ Press the ◀ to decrease the contrast.
- ▶ Press the ▶ to increase the contrast.

### White Peaking

Use the white peaking control to set the white peaking level of DMD chip. 0 stands for minimal peaking, and 10 stands for maximum peaking. If you prefer a brighter image, adjust towards the maximum setting. For a smooth and more natural image, adjust towards the minimum setting.

### Colour Temperature

Adjusts the colour temperature. At higher temperature, the screen looks colder; at lower temperature, the screen looks warmer.

Each display mode has its own colour temperature and can memorize user’s selection. For example:

Display mode	PC	Photo	Video	sRGB	User
Colour Temp.	sRGB	Low	User	High	Mid.
Default setting	Mid.	High	High	sRGB	High

When you adjust the colour setting item, the colour temperature will be set as “User” automatically. And this set “User” is the same for all display mode. (See the section of “Colour” for details.)

### Saturation

Adjusts a video image from black and white to fully saturated colour.

- ▶ Press the ◀ to decrease the amount of saturation in the image.
- ▶ Press the ▶ to increase the amount of saturation in the image.

### Sharpness

Adjusts the sharpness of the image.

- ▶ Press the ◀ to decrease the sharpness.
- ▶ Press the ▶ to increase the sharpness.

**NOTE**

• “Saturation” functions is only supported under Video mode.



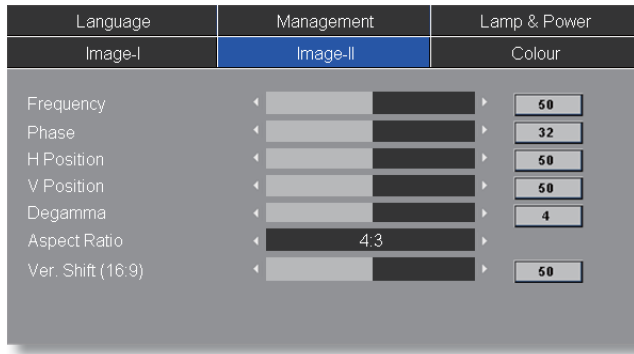

## *Image-II*

### Frequency

“Frequency” changes the display data frequency to match the frequency of your computer’s graphic card. If you experience a vertical flickering bar, use this function to make an adjustment.

### Phase

“Phase” synchronizes the signal timing of the display with the graphic card. If you experience an unstable or flickering image, use this function to correct it.

### H Position (Horizontal Position)

- ▶ Press the ◀ to move the image left.
- ▶ Press the ▶ to move the image right.

### V Position (Vertical Position)

- ▶ Press the ◀ to move the image down.
- ▶ Press the ▶ to move the image up.

### Degamma

This allows you to choose a degamma table that has been fine-tuned to bring out the best image quality for the input.

### Aspect Ratio

Use this function to choose your desired aspect ratio.

- ▶ 4:3 : The input source will be scaled to fit the projection screen.
- ▶ 16:9 : The input source will be scaled to fit the width of the screen.
- ▶ Window: When a 4:3 image is bigger than a 16:9 screen, select the “Window” mode to fit the image onto the screen without changing the projection distance.

#### NOTE

- “Frequency”, “Phase”, “H Position” and “V Position” functions are only supported under Computer mode.

- ▶ **LBX:** This format is for non-16x9, letterbox source and for users who use external 16x9 lens to display 2.35:1 aspect ratio using full resolution.

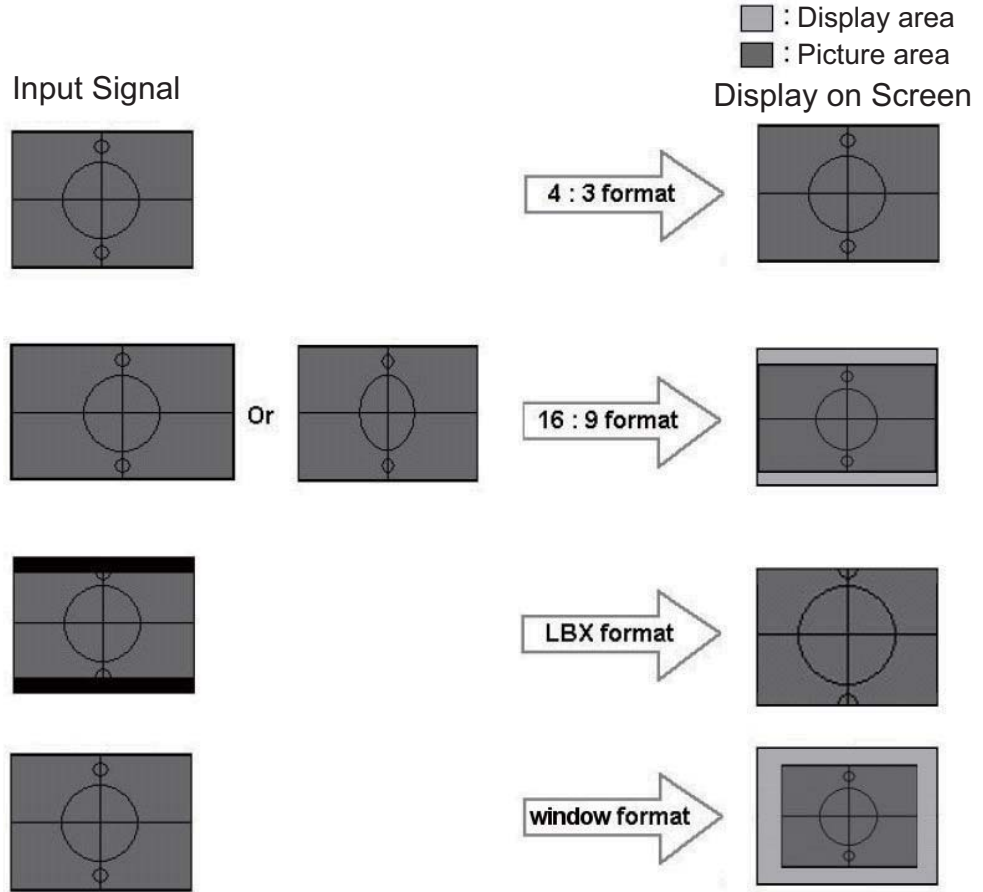

Ver. Shift (16:9)

**NOTE**  
 • Ver. Shift (16:9):  
 Image Position at window mode will also be moved accordingly.

Adjust the image position up or down, when you select the aspect ratio of 16:9.

- ▶ Press the ◀ to move the image down.
- ▶ Press the ▶ to move the image up.



# Colour

## Colour

- f** Full Range: Adjust the Red, Green and Blue color for all screen.
- e** Enhance Individual: Adjust the Red, Green, Blue, Yellow, Cyan and Magenta colors for advanced adjustment of the individual colors.

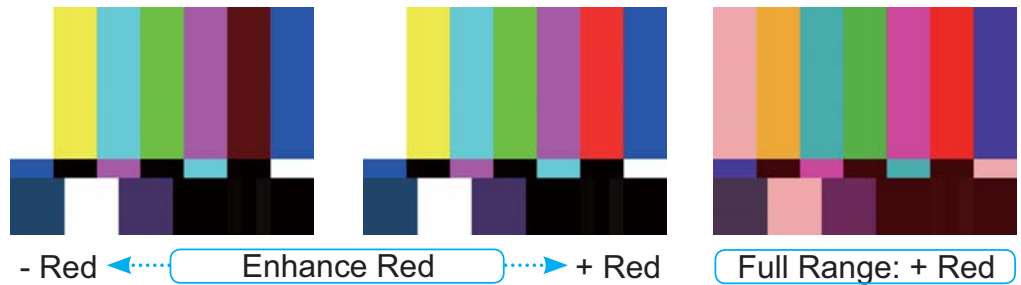

When you adjust the colour setting item, the colour temperature will be set as "User" automatically. And this set "User" is the same for all display mode. For example:

Icon	Colour Temp.
L	Low
M	Mid
H	High
S	sRGB
U	User

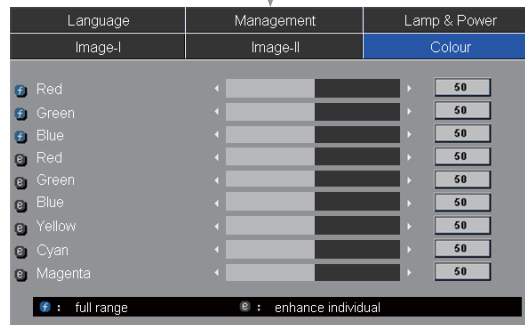
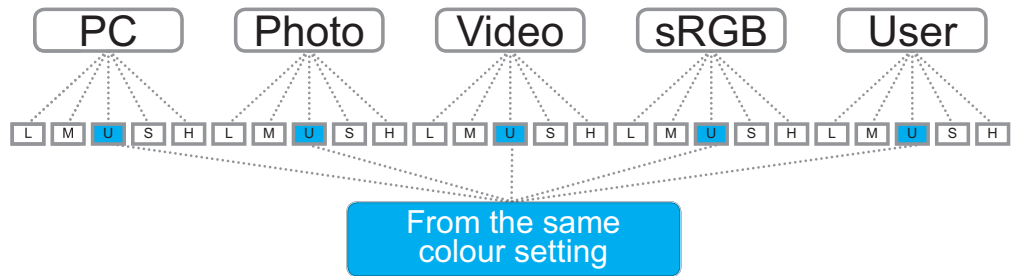

Different color setting will be memorized at 4 different source groups. But they will be same under same source.

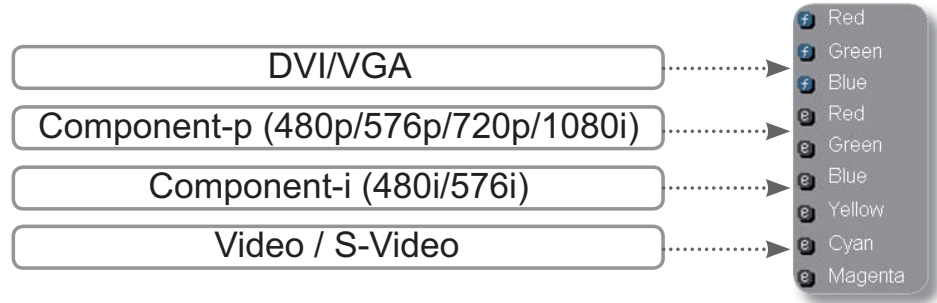

When we adjust color setting the current color temperature will be memorized before it auto switch to “User”. Because the memorized color temperature will be a base of “User”. For example:

1.) Colour Temperature is High.



2.) User creates his favorite color based on “High” setting of colour temperature. So when user switches colour temperature to “User”, will find the image color temperature close to “High”.



Image-I	Image-II	Colour
Language	Management	Lamp & Power
English	Nederlands	中文(简体)
Français	Suomi	中文(繁體)
Deutsch	ελληνικά	日本語
Italiano	Dansk	한국어
Español	Norsk	
Português	Polski	
Svenska	Русский	

## *Language*

### Language

Choose the multilingual OSD menu. Use the ▲ or ▼ key to select your preferred language.

Press “Enter” to finalize the selection.

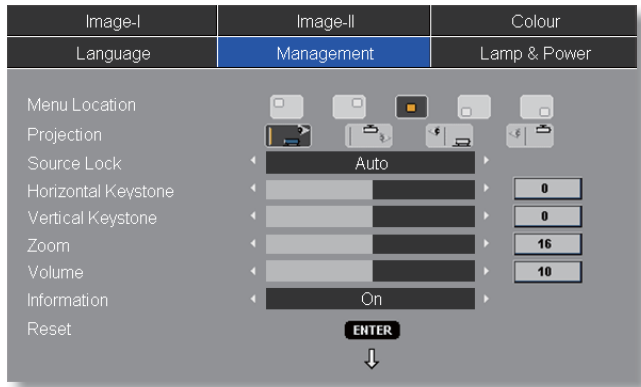





## Management

### Menu Location

Choose the menu location on the display screen.

### Projection

- ▶  Front-Desktop  
The factory default setting.
- ▶  Front-Ceiling  
When you select this function, the projector turns the image upside down for ceiling-mounted projection.
- ▶  Rear-Desktop  
When you select this function, the projector reverses the image so you can project from behind a translucent screen.
- ▶  Rear-Ceiling  
When you select this function, the projector reverses and turns the image upside down. You can project from behind a translucent screen with ceiling mounted projection.

### Source Lock

- ▶ Auto: The projector will search all connection port.
- ▶ Lock: The projector will lock connection port.

### Horizontal Keystone

Press the ◀ or ▶ to adjust image distortion horizontally and makes a squarer image.

### Vertical Keystone

Press the ◀ or ▶ to adjust image distortion vertically and makes a squarer image.

### Zoom

- ▶ Press the ◀ to reduce the size of an image.
- ▶ Press the ▶ to magnify an image on the projection screen.

### Volume

- ▶ Press ◀ to decrease the volume.
- ▶ Press ▶ to increase the volume.

### Information

To display source information on the screen.



### Reset

Choose “Enter” to return the adjustments and settings to the factory default values.

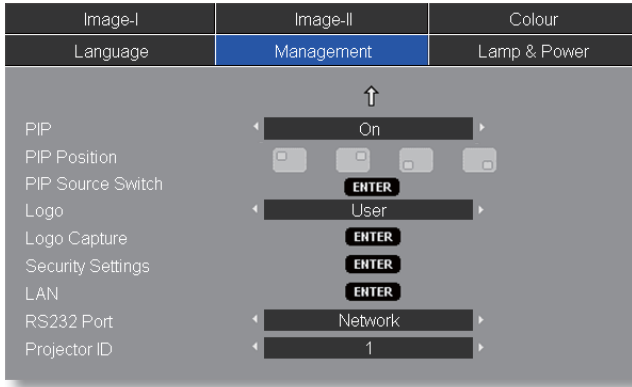

# Management

## PIP

Choose “On” to select on the PIP screen, choose “Off” to select off the PIP screen.

## PIP Position

Choose the PIP screen position on the display screen.



## PIP Source Switch

Press “Enter” to switch PIP screen source.

**PIP RULE TABLE**

Main source	Sub source				
	DVI-D	VGA	Componet-p	S-video	Video
DVI-D (digital RGB / HDCP)	x	x	x	✓	✓
VGA (analog RGB)	x	x	x	✓	✓
Componet-p (480p/576p/720p/1080i)	x	x	x	✓	✓
S-video	x	x	x	x	x
Video	x	x	x	x	x

## Logo

Use this function to select your desired startup screen. If you change the setting from one to another, when you exit the OSD menu, the new setting will take effect on next open.



- ▶ 3M: The default startup screen of 3M projector.
- ▶ User: Use memorize picture from “Logo Capture” function.

### Logo Capture

Press “Enter” to immediately capture a picture what on the display screen.

### Security Settings

#### ■ **First Time:**

1. Press “Enter” to set password.
2. The Password is 4 digits, DEFAULT VALUE is “0000”. (first time)
3. Use number buttons on the remote to select your password, and then press “Enter” key to confirm your selection.

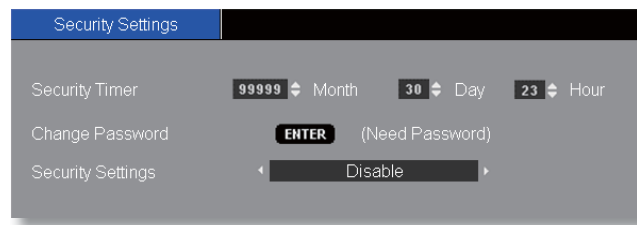
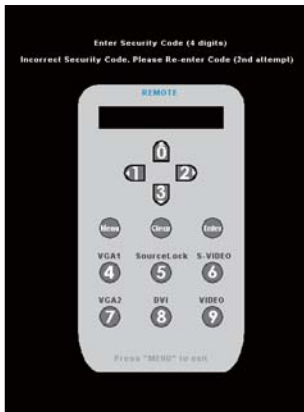

- ▶ **Security Timer:** Can be select the time (month/day/hour) function to set the number of hours the projector can be used. Once this time has elapsed you will be requested to enter your password again. (Use number buttons on remote. To change password, follow change password instructions above.)
- ▶ **Change Password:**
  1. Press “Enter” to input old password.
  2. Use number button to enter current password, and then press “Enter” key again to reveal next OSD menu.
  3. Scroll down to highlight Password, and then press “Enter” to activate.
  4. Enter new password (4 digits in length) using the number buttons on the remote, then press “Enter” to confirm.
  5. Enter new password again and press “Enter” to confirm.
- ▶ **Security settings:**
  - Enable: Choose “Enable” to enable security verification when turning on the projector.
  - Disable: Choose “Disable” to be able to switch on the projector without password verification.

## LAN

Press “Enter” to apply LAN settings. If the connection is successful, the OSD display will show the following dialogue box.



- ▶ Network State: To display network information.
- ▶ DHCP:
  - Enable: Assign an IP address to the projector from the DHCP server automatically.
  - Disable: Assign an IP address manually.
- ▶ IP Address: Select an IP address.
- ▶ Subnet Mask: Select subnet mask number.
- ▶ Gateway: Select the default gateway of the network connected to the projector.
- ▶ DNS: Select DNS number.
- ▶ Apply: Press “Enter” to apply the selection.

## RS232 Port

- ▶ RS232: Allows RS232 control of an individual projector.
- ▶ Network: Allows LAN via web browser (Internet Explorer) to control of projector. (Default setting)

## Projector ID

ID definition can be set up by menu (range 01~99), and allow user control an individual projector by RS232. The related order please refer page 44.

## How to use web browser to control your projector

1. Fill in a new IP, a subnet mask, a gateway and a DNS in the dialogue box.



2. Then choose apply and press “Enter” button to effectuate the configuration process.
3. Open your web browser and type in from the OSD LAN screen then the web page will display as below:

**NOTE**

- When you used the projector IP address, you will can not link to your service server.



4. Open “Control Panel” to control your projector.

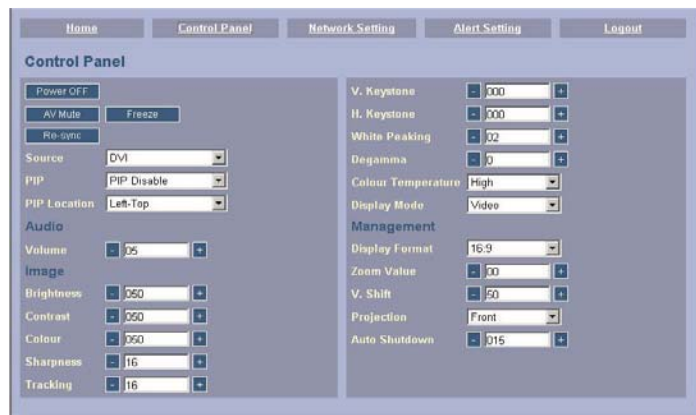

**For example: Use Microsoft Internet Explorer (IE) web browser to control the projector , the IP address is http:// 10.0.50.100.**

Step 1: Find an IP Address (10.0.50.100) from LAN function of projector.



Step 2: Select apply and press “Enter” button to submit function or press “menu” key to exit.

Step 3: To open Network Connections, click **Start**, click **Control Panel**, click **Network and Internet Connections**, and then click **Network Connections**. Click the connection you want to configure, and then, under **Network Tasks**  , click **Change settings of this connection**.

Step 4: On the **General** tab, under **This connection uses the following items**, click **Internet Protocol (TCP/IP)**, and then click “Properties.”

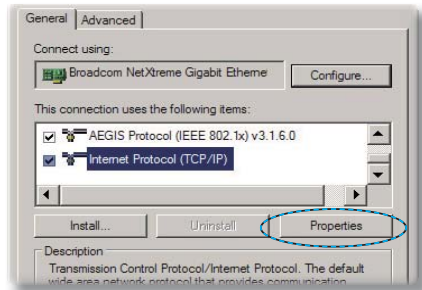

Step 5: Click **Use the following IP address**, and type in as below:

- 1) IP address: 10.0.50.XXX
- 2) Subnet mask: 255.255.0.0
- 3) Default gateway: 10.0.50.254

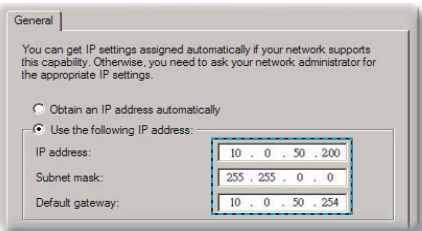

Step 6: To open Internet Options, click IE web browser, click Internet Options, click the **Connections tab** and click “LAN Settings...”

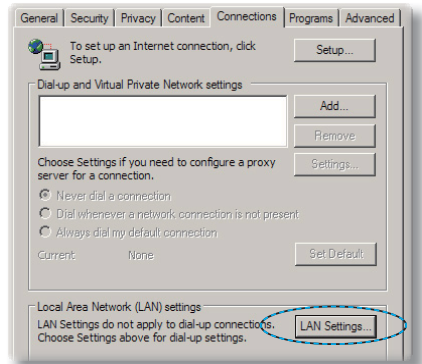

Step 7: The **Local Area Network (LAN) Setting** dialog box appears, In the **Proxy Server** area, cancel the **Use a proxy server for your LAN check box.**, then click “OK” button twice.

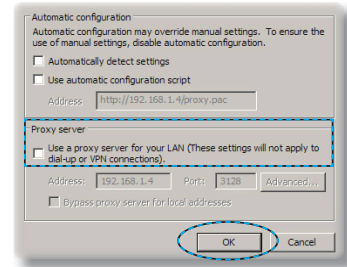

Step 8: Open your IE and type in the IP address of 10.0.50.100 in the URL then press “Enter” key. The web page will display as below:



Step 9: Open “Control Panel” to control your projector.

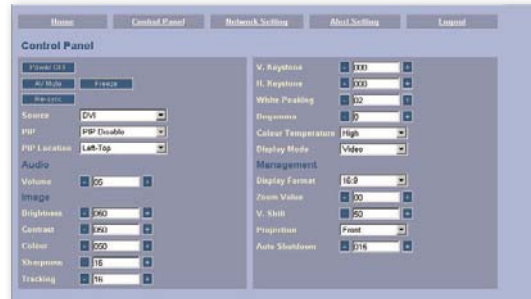



## *Lamp & Power*

### STD Mode

Choose “On” to dim the projector lamp which will lower power consumption and extend the lamp life by up to 130%. Choose “Off” to return to BRIGHT mode.

### High Altitude

Choose “On” to turn on High Altitude mode. Operates the fans at full speed continuously to allow for proper high altitude cooling of the projector.

### Auto Power Off

Sets the countdown timer interval. The countdown timer will start, when there is no signal being sent to the projector. Then projector will automatically power off when the countdown has finished. (in minutes)

### Sleep Timer

Sets the countdown timer interval. The timer will begin, with or without a signal input. Then the projector will automatically power off then the sleep timer countdown has finished. (in minutes)

### Projection Hours

Displays the projection time.

### Lamp Hour

Displays the cumulative lamp operating time.

### Lamp Reset

Resets the lamp life hour counter after replacing the lamp.

## Troubleshooting

*If you experience trouble with the projector, refer to the following information. If the problem persists, please contact your local reseller or service center.*

### **Problem: No image appears on screen**

- ▶ Ensure all the cables and power connections are correctly and securely connected as described in the “Installation” section.
- ▶ Ensure the pins of connectors are not crooked or broken.
- ▶ Check if the projection lamp has been securely installed. Please refer to the “Replacing the lamp” section.
- ▶ Make sure you have removed the lens cap and the projector is switched on.
- ▶ Ensure that the “AV Mute” feature is not turned on.

### **Problem: Left of right edge of the image is missing or the image is unstable or noisy**

- ▶ Press “Re-Sync” on the remote control or on control panel.
- ▶ If you are using a PC:

#### For Windows 3.x:

1. In the Windows Program Manager, double click the “Windows Setup” icon in the Main group.
2. Verify that your display resolution setting is less than or equal to 1600 x 1200.

#### For Windows 95, 98, 2000, XP:

1. From the “My Computer” icon, open the “Control Panel” folder, and double click the “Display” icon.
2. Select the “Settings” tab.
3. Click on the “Advanced Properties” button.

**If the projector is still not projecting the whole image, you will also need to change the monitor display you are using. Refer to the following steps.**

4. Verify the resolution setting is less than or equal to 1600 x 1200 resolution.

5. Select the “Change” button under the “Monitor” tab.
  6. Click on “Show all devices.” Next, select “Standard monitor types” under the SP box; choose the resolution mode you need under the “Models” box.
- ▶ If you are using a Notebook:
1. First, follow the steps above to adjust resolution of the computer.
  2. Press the toggle output settings. example: [Fn]+[F3]

Compaq ⇒ [Fn]+[F4]	Hewlett ⇒ [Fn]+[F4]
Dell ⇒ [Fn]+[F8]	Packard ⇒ [Fn]+[F4]
Gateway ⇒ [Fn]+[F4]	NEC ⇒ [Fn]+[F3]
IBM ⇒ [Fn]+[F7]	Toshiba ⇒ [Fn]+[F5]

Mac Apple:  
System Preference⇒Display⇒Arrangement⇒Mirror display

- ▶ If you experience difficulty changing resolutions or your monitor freezes, restart all equipment including the projector.

**Problem: The screen of the Notebook or PowerBook computer is not displaying a presentation**

- ▶ If you are using a Notebook PC:  
Some Notebook PCs may deactivate their own screens when a second display device is in use. Each has a different way to be reactivated. Refer to your computer’s documentation for detailed information.

**Problem: Image is unstable or flickering**

- ▶ Use “Phase” to correct it. (see page 23)
- ▶ Change the monitor colour setting on your computer.

**Problem: Image has vertical flickering bar**

- ▶ Use “Frequency” to make an adjustment. (see page 23)
- ▶ Check and reconfigure the display mode of your graphic card to make it compatible with the product.



**Problem: Image is out of focus**

- ▶ Adjust the Focus Ring on the projector lens.
- ▶ Make sure the projection screen is between distance 3.3 to 40.0 feet (1.0 to 12.2 meters) from the projector. (see page 15)

**Problem: The image is stretched when displaying 16:9 DVD**

The projector automatically detects 16:9 DVD and adjusts the aspect ratio by digitizing to full screen with 4:3 default setting.

If the image is still stretched, you will also need to adjust the aspect ratio by referring to the following:

- ▶ Please select 4:3 aspect ratio type on your DVD player if you are playing a 16:9 DVD.
- ▶ If you can't select 4:3 aspect ratio type on your DVD player, please select 4:3 aspect ratio in the on screen menu.

**Problem: Image is reversed**

- ▶ Select "Management ⇨ Projection" from the OSD and adjust the projection direction. (see page 28)

**Problem: Lamp burns out or makes a popping sound**

- ▶ When the lamp reaches its end of life, it will burn out and may make a loud popping sound. If this happens, the projector will not turn on until the lamp module has been replaced. To replace the lamp, follow the procedures in the "Replacing the Lamp". (see page 41)

**Problem: LED lighting message**

Message	Power-LED		Temp-LED	Lamp-LED
	(Green)	(Red)		
Standby State (Input power cord)	○	☀	○	○
Warming	Flashing	○	○	○
Normal Mode	☀	○	○	○
Cooling	○	Flashing	○	○
Error (Lamp failed)	○	○	○	☀
Error (Fan failed)	○	○	○	Flashing
Error (Over Temp.)	○	○	☀	○

**NOTE**  
 • Steady light ⇨ ☀  
 No light ⇨ ○

**Problem: Message Reminders**

▶ Fan fail:

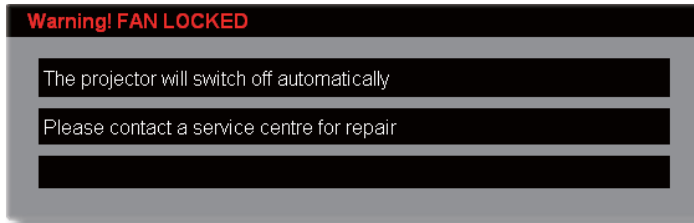

▶ Over temperature:

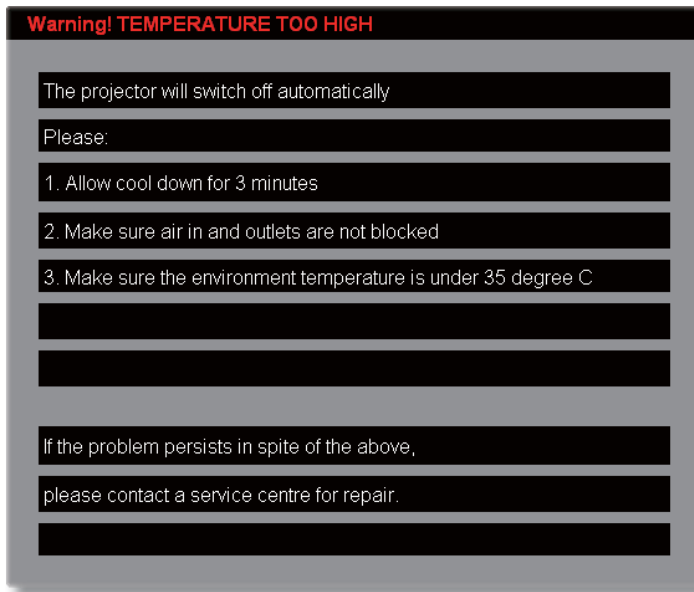

▶ Power Off:

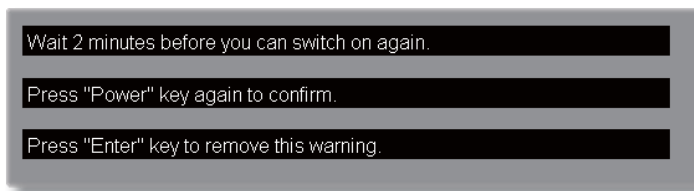

▶ Replace the lamp:



## Replacing the Lamp

The projector keeps track of the lamp usage. It will show you a warning message:



- Warning: Lamp compartment is hot! Allow 30 minutes to cool down before changing lamp!



When you see this message, change the lamp as soon as possible. Make sure the projector has cooled down for at least 30 minutes before changing the lamp.

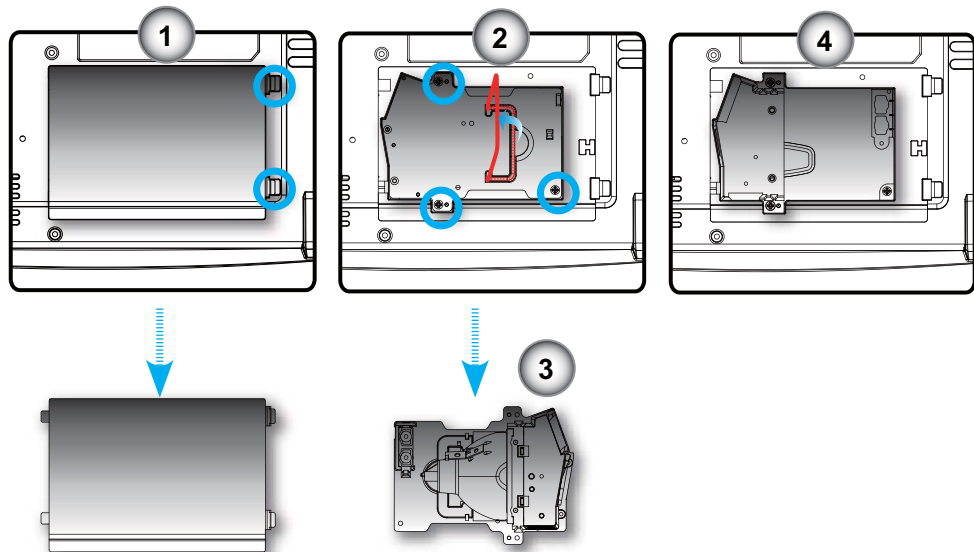

- Warning: To reduce the risk of personal injury, do not drop the lamp module or touch the lamp bulb. The bulb may shatter and cause injury if it is dropped.

### Lamp Replacement Procedure:

1. Turn off the power by pressing the Power/Standby button.
2. Allow the projector to cool down for at least 30 minutes.
3. Disconnect the power cord.
4. Push up and remove the cover. ❶
5. Use a screwdriver to remove the 3 screws from the lamp module. ❷
6. Pull out the lamp module. ❸

To replace the lamp module, reverse the previous steps.

## Compatibility Modes

Mode	Resolution	(ANALOG)		(DIGITAL)	
		V.Frequency (Hz)	H.Frequency (kHz)	V.Frequency (Hz)	H.Frequency (kHz)
VESA VGA	640 x 350	70	31.5	70	31.5
VESA VGA	640 x 350	85	37.9	85	37.9
VESA VGA	640 x 400	85	37.9	85	37.9
VESA VGA	640 x 480	60	31.5	60	31.5
VESA VGA	640 x 480	72	37.9	72	37.9
VESA VGA	640 x 480	75	37.5	75	37.5
VESA VGA	640 x 480	85	43.3	85	43.3
VESA VGA	720 x 400	70	31.5	70	31.5
VESA VGA	720 x 400	85	37.9	85	37.9
VESA SVGA	800 x 600	56	35.2	56	35.2
VESA SVGA	800 x 600	60	37.9	60	37.9
VESA SVGA	800 x 600	72	48.1	72	48.1
VESA SVGA	800 x 600	75	46.9	75	46.9
VESA SVGA	800 x 600	85	53.7	85	53.7
VESA XGA	1024 x 768	60	48.4	60	48.4
VESA XGA	1024 x 768	70	56.5	70	56.5
VESA XGA	1024 x 768	75	60.0	75	60.0
VESA XGA	1024 x 768	85	68.7	85	68.7
* VESA SXGA	1152 x 864	70	63.8	70	63.8
* VESA SXGA	1152 x 864	75	67.5	75	67.5
* VESA SXGA	1152 x 864	85	77.1	85	77.1
* VESA SXGA	1280 x 1024	60	63.98	60	63.98
* VESA SXGA	1280 x 1024	75	79.98	75	79.98
* VESA SXGA	1280 x 1024	85	91.1	85	91.1
* VESA SXGA+	1400 x 1050	60	63.98	60	63.98
* VESA UXGA	1600 x 1200	60	75	60	75

**NOTE**  
 • Remark : “\*”  
 compressed  
 computer image.

Mode	Resolution	(ANALOG)		(DIGITAL)	
		V.Frequency (Hz)	H.Frequency (kHz)	V.Frequency (Hz)	H.Frequency (kHz)
MAC LC 13”	640 x 480	66.66	34.98	***	***
MAC II 13”	640 x 480	66.68	35	***	***
MAC 16”	832 x 624	74.55	49.725	***	***
MAC 19”	1024 x 768	75	60.24	***	***
* MAC	1152 x 870	75.06	68.68	***	***
MAC G4	640 x 480	60	31.35	***	***
i MAC DV	1024 x 768	75	60	***	***
* i MAC DV	1152 x 870	75	68.49	***	***
* i MAC DV	1280 x 960	60	60	***	***

## Ceiling Mount Installation

1. To prevent damaging your projector, please use the ceiling mount package for installation.
2. If you wish to use a third party ceiling mount kit, please ensure the screws used to attached a mount to the projector meet the following specifications:

### NOTE

- Please note that damage resulting from incorrect installation will invalidate the warranty.



- If you buy the ceiling mount from another manufacturer, please ensure that there is at least 10cm distance between the bottom cover of the projector and the ceiling.
- Avoid placing the projector near sources of heat such as air-conditioning units and heaters otherwise it may overheat and shut down automatically.

- ▶ **Screw type: M3**
- ▶ **Maximum screw length: 10mm**
- ▶ **Minimum screw length: 8mm**

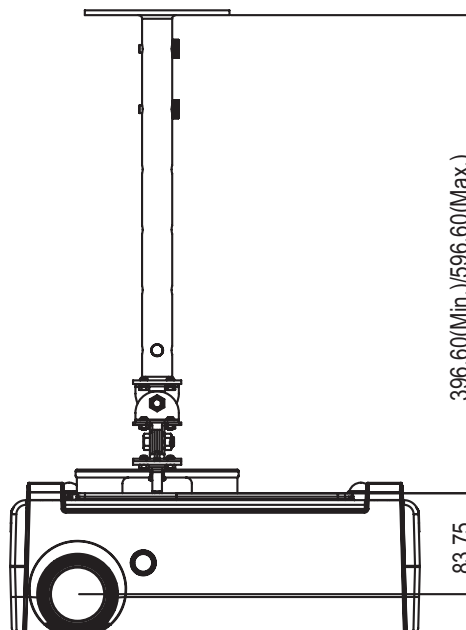
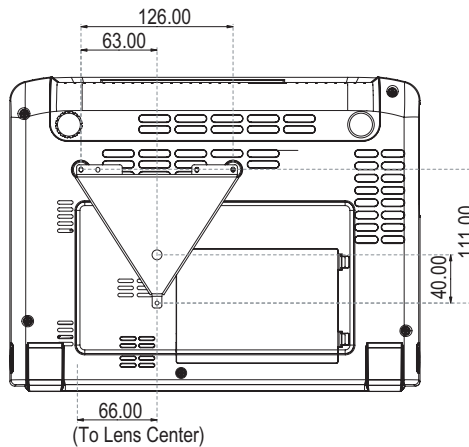

# RS232 Protocol Function List

Baud Rate : 9600  
 Data Bits: 8  
 Parity: None  
 Stop Bits: 1  
 Flow Control : None  
 UART16550 FIFO: Disable

**SEND to projector**

232 ASCII Code	HEX Code	Function	Projector Return	Description
IDnnIR101	49 44 30 30 49 52 31 30 31	Power ON	OK	nn=01-99, projector's ID, nn=00 is for all projectors.
IDnnIR100	49 44 30 30 49 52 31 30 30	Power OFF	OK	
IDnnIR001	49 44 30 30 49 52 30 30 31	Eco. mode on	OK	
IDnnIR002	49 44 30 30 49 52 30 30 32	Eco. mode off	OK	
IDnnIR003	49 44 30 30 49 52 30 30 33	Resync.	OK	
IDnnIR004	49 44 30 30 49 52 30 30 34	Freeze	OK	
IDnnIR005	49 44 30 30 49 52 30 30 35	Unfreeze	OK	
IDnnIR006	49 44 30 30 49 52 30 30 36	Source lock on	OK	
IDnnIR007	49 44 30 30 49 52 30 30 37	Source lock off	OK	
IDnnIR008	49 44 30 30 49 52 30 30 38	A/V mute on	OK	
IDnnIR009	49 44 30 30 49 52 30 30 39	A/V mute off	OK	
IDnnIR010	49 44 30 30 49 52 30 31 30	zoom plus	OK	
IDnnIR011	49 44 30 30 49 52 30 31 31	zoom minus	OK	
IDnnIR012	49 44 30 30 49 52 30 31 32	up (Pan under zoom)	OK	
IDnnIR013	49 44 30 30 49 52 30 31 33	down (Pan under zoom)	OK	
IDnnIR014	49 44 30 30 49 52 30 31 34	left (Pan under zoom)	OK	
IDnnIR015	49 44 30 30 49 52 30 31 35	right (Pan under zoom)	OK	
IDnnIR016	49 44 30 30 49 52 30 31 36	reset	OK	
IDnnIR017	49 44 30 30 49 52 30 31 37	Information on	OK	
IDnnIR018	49 44 30 30 49 52 30 31 38	Information off	OK	
IDnnIR020	49 44 30 30 49 52 30 32 30	Source select	DVI-D OK	
IDnnIR021	49 44 30 30 49 52 30 32 31	"	D-sub1 OK	
IDnnIR022	49 44 30 30 49 52 30 32 32	"	D-sub2 OK	
IDnnIR023	49 44 30 30 49 52 30 32 33	"	S-video OK	
IDnnIR024	49 44 30 30 49 52 30 32 34	"	Video OK	
IDnnIR030	49 44 30 30 49 52 30 33 30	Display forma	16:9 OK	
IDnnIR031	49 44 30 30 49 52 30 33 31	"	4:3 OK	
IDnnIR032	49 44 30 30 49 52 30 33 32	"	window OK	
IDnnIR033	49 44 30 30 49 52 30 33 33	"	LetterBox OK	
IDnnIR040	49 44 30 30 49 52 30 34 30	Color temp.	low OK	
IDnnIR041	49 44 30 30 49 52 30 34 31	"	medium OK	
IDnnIR042	49 44 30 30 49 52 30 34 32	"	high OK	
IDnnIR043	49 44 30 30 49 52 30 34 33	"	sRGB OK	
IDnnIR044	49 44 30 30 49 52 30 34 34	"	User OK	
IDnnIR050	49 44 30 30 49 52 30 35 30	Display mode	PC OK	
IDnnIR051	49 44 30 30 49 52 30 35 31	"	Photo OK	
IDnnIR052	49 44 30 30 49 52 30 35 32	"	Video OK	
IDnnIR053	49 44 30 30 49 52 30 35 33	"	sRGB OK	
IDnnIR054	49 44 30 30 49 52 30 35 34	"	User OK	
IDnnIR060	49 44 30 30 49 52 30 36 30	Projection way	front OK	
IDnnIR061	49 44 30 30 49 52 30 36 31	"	front + ceiling OK	
IDnnIR062	49 44 30 30 49 52 30 36 32	"	rear OK	
IDnnIR063	49 44 30 30 49 52 30 36 33	"	rear + ceiling OK	
IDnnIR070	49 44 30 30 49 52 30 37 30	PIP	enable OK	
IDnnIR071	49 44 30 30 49 52 30 37 31	PIP	disable OK	
IDnnIR072	49 44 30 30 49 52 30 37 32	PIP location	Top-Left OK	
IDnnIR073	49 44 30 30 49 52 30 37 33	"	Top-Right OK	
IDnnIR075	49 44 30 30 49 52 30 37 35	"	Bottom-Left OK	
IDnnIR076	49 44 30 30 49 52 30 37 36	"	Bottom-Right OK	
IDnnIR080nnn		brightness	OK	nnn=000-100 , osd show value 0-100.
IDnnIR081nnn		contrast	OK	nnn=000-100 , center is 50
IDnnIR082nnn		volume	OK	nnn=000-030 , center is 15
IDnnIR083nnn		white intensity	OK	nnn=000-010
IDnnIR084nnn		sharpness	OK	nnn=001-032
IDnnIR085nnn		phase	OK	nnn=000-063
IDnnIR086nnn		digamma	OK	nnn=000-007
IDnnIR087nnn		vert. shift(16:9 only)	OK	nnn=000-100
IDnnIR088nnn		hor.keystone	OK	nnn= -40 ...000 ... 040 , eg: "IR088-35 " will set hor.keystone value as -35
IDnnIR089nnn		ver.keystone	OK	nnn= -40 ...000 ...040 , eg: "IR088035 " will set ver.keystone value as +35
IDnnIR090nnn		auto power off	OK	nnn=000-180
IDnnIR091nnn		sleep timer	OK	nnn=000-180
IDnnIR092nnn		color	OK	nnn=000-100

**SEND from projector automatically**

when got invalid command NG  
 when standby/warming/cooling/out of range INFO n : 0/1/2/3 = standby / warming / cooling / out range

**READ from projector**

232 ASCII Code	HEX Code	Function	Projector Return	Description
IDnnIR098	49 44 30 30 49 52 30 39 38	Information	OKabbbbdde	a : 1/0=on/off bbbb: LampHour c: source 0/1/2/3/4/5= none/dvi/vga1/vga2/s-video/video dddd: FW version e : display mode
IDnnIR099	49 44 30 30 49 52 30 39 39	Info. to web only	OK[data]	( !!! Caution !!! data[ ] are all ASIC character.) data[0] : 1/0=on/off data[1..4] : LampHour XXXX data[5] : source 0/1/2/3/4/5= none/dvi/vga1/vga2/s-video/video data[6..9] : FW version data[10] : display format 0/1/2/3=4:3/16:9/window/native data[11] : display mode 0/1/2/3/4=PC/Photo/Video/sRGB/User data[12..13] : volume XX data[14..16] : brightness XXX data[17..19] : contrast XXX data[20..22] : colour XXX data[23] : AV mute 1/0=on/off data[24] : Freeze 1/0=on/off data[25] : Lamp lite 1/0= ok/failed. data[26] : (bright mode) Economic mode 0/1= off/on. data[27] : (screen) pip 0/1=disable/enable data[28] : pip location 0/1/2/3/4=left-top/right-top/center/left-bottom/right-bottom data[29] : colour temperature 0/1/2/3/4=low/med/high/sRGB/user data[30] : projection 0/1/2/3=front/front-ceiling/rear/rear-ceiling. data[31] : digamma X data[32..33] : language XX 0=English 1=Français 2=Deutsch 3=Italiano 4=Español 5=Português 6=Svenska 7=Nederlands 8=Finnish 9=Greek 10=Danish 11=Norsk 12=Poliski 13=Русский 14=简体中文 15=繁體中文 16=日本語 17=한국어 data[34..35] : sharpness XX data[36..37] : tracking XX data[38..39] : white peaking XX data[40..41] : (zoom value) zoom XX data[42..43] : vertical shift XX data[44..46] : vertical position XXX data[47..49] : horizontal position XXX data[50..52] : vertical keystone XXX data[53..55] : horizontal keystone XXX data[56..58] : (auto shutdown) auto power off XXX

### RS232 Connector

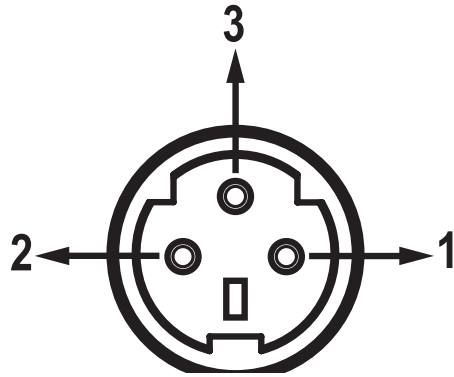

Pin no.	Name	I/O (From Projector Side)
1	TXD	OUT
2	RXD	IN
3	GND	—

### VGA-In Connector

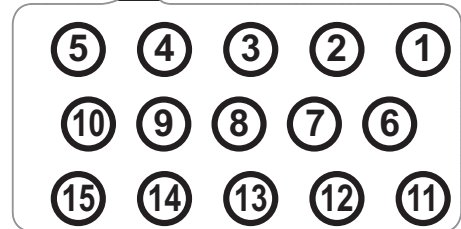
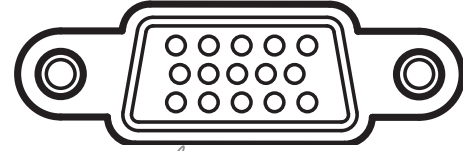

Pin no.	Spec.
1	R(RED)/Cr
2	G(GREEN)/Y
3	B(BLUE)/Cb
4	NC
5	GND
6	GND
7	GND
8	GND
9	DDC 5V
10	HOT-DET
11	NC
12	DDC Date
13	HS/CS
14	VS
15	DDC Clock



## Regulation & Safety notices

This appendix lists the general notices of your Projector.

### FCC notice

This device has been tested and found to comply with the limits for a Class B digital device pursuant to Part 15 of the FCC rules. These limits are designed to provide reasonable protection against harmful interference in a residential installation. This device generates, uses, and can radiate radio frequency energy and, if not installed and used in accordance with the instructions, may cause harmful interference to radio communications.

However, there is no guarantee that interference will not occur in a particular installation. If this device does cause harmful interference to radio or television reception, which can be determined by turning the device off and on, the user is encouraged to try to correct the interference by one or more of the following measures:

- Reorient or relocate the receiving antenna.
- Increase the separation between the device and receiver.
- Connect the device into an outlet on a circuit different from that to which the receiver is connected.
- Consult the dealer or an experienced radio/television technician for help.

### Notice: Shielded cables

All connections to other computing devices must be made using shielded cables to maintain compliance with FCC regulations.

### Caution

Changes or modifications not expressly approved by the manufacturer could void the user's authority, which is granted by the Federal Communications Commission, to operate this computer.

## Operation conditions

This device complies with Part 15 of the FCC Rules. Operation is subject to the following two conditions:

1. this device may not cause harmful interference, and
2. this device must accept any interference received, including interference that may cause undesired operation.

## Notice: Canadian users

This Class B digital apparatus complies with Canadian ICES-003.

## Remarque à l'intention des utilisateurs canadiens

Cet appareil numérique de la classe B est conforme à la norme NMB-003 du Canada.

## Declaration of Conformity for EU countries

- EMC Directive 89/336/EEC (including amendments)
- Low Voltage Directive 73/23/EEC (amended by 93/68/EEC)
- R & TTE Directive 1999/EC (if product has RF function)

## Disposal instructions



Do not throw this electronic device into the trash when discarding. To minimize pollution and ensure utmost protection of the global environment, please recycle it.