

myprojectorlamps.com

**The most trusted, dependable name
in projector lamp sales.**



<http://www.myprojectorlamps.com>



<http://www.myprojectorlamps.ca>



<http://www.myprojectorlamps.eu>

The following projector manual has not been modified or altered in any way.

USER'S GUIDE



BOXLIGHT XD-5m



19332 Powder Hill Place
Poulsbo, WA 98370-7407 USA

www.boxlight.com

Direct Phone:

USA: (360) 779-7901

Europe: +44 (0) 1732-840-404

Free phone within these areas:

United Kingdom: 0800-762-575

Germany: 0800-180-8381

France: 0800-9132-88

USA and Canada: 800-762-5757

FCC Warning

This equipment has been tested and found to comply with the limits for a Class A digital device, pursuant to part 15 of the FCC Rules. These limits are designed to provide reasonable protection against harmful interference when the equipment is operated in a commercial environment. This equipment generates, uses, and can radiate radio frequency energy and, if not installed and used in accordance with the instruction manual, may cause harmful interference to radio communications. Operation of this equipment in a residential area is likely to cause harmful interference in which case the user will be required to correct the interference at his own expense.

Canada

This Class A digital apparatus complies with Canadian ICES-003.
Cet appareil numérique de la classe A est conforme à la norme NMB-003 du Canada.

Safety Certifications

UL, CUL, TÜV, NOM

EN 55022 Warning

This is a Class A product. In a domestic environment it may cause radio interference, in which case the user may be required to take adequate measures. The typical use is in a conference room, meeting room or auditorium.

Declaration of Conformity

Manufacturer: Boxlight

19332 Powder Hill Place, Washington, USA

We declare under our sole responsibility that the XD-5m Projector conforms to the following directives and norms:

Directive 89/336/EEC, Amended by 93/68/EEC

EMI: EN 55022 (1992) Class A

EMC: EN 50082-1 (1992)

IEC 801-2, IEC 801-3, IEC 801-4

Directive 73/23/EEC, Amended by 93/68/EEC

Safety: EN 60950: 1992 + A1 + A2 + A3: 1995

July, 1999

Trademarks

Apple, Macintosh, and PowerBook are trademarks or registered trademarks of Apple Computer, Inc. IBM and PS/2 are trademarks or registered trademarks of International Business Machines, Inc. MicroSaver and Kensington are trademarks or registered trademarks of Kensington Microware Limited. Microsoft, PowerPoint, and Windows are trademarks or registered trademarks of Microsoft Corporation. Digital Light Processing is a trademark or registered trademark of Texas Instruments.



TABLE OF CONTENTS

Safety Instructions	iii
Introduction	1
Image Resolution	1
Compatibility	1
Unpacking the Projector	1
Usage Guidelines	3
If You Need Assistance	4
Warranty	4
Setting up the Projector	5
Connecting a Computer	7
Connecting a Video Player	9
Powering up the Projector and Adjusting the Image	11
Turning Off the Projector	12
Using the Projector	13
Basic Image Adjustment	13
Using the Remote Control	13
Adjusting the Projector	15
Using the Keypad and Remote Buttons	16
Using the On-Screen Menus	18
Display Menu	19
Audio Menu	20
Image Menu	21
Controls Menu	23
Language Menu	25
Status Menu	26
Maintenance & Troubleshooting	27
Cleaning the Lens	27
Replacing the Projection Lamp	27
Replacing the Batteries in the Remote Control	30
Using the Kensington Lock	30
Troubleshooting	31

Appendix	35
Specifications	35
Accessories	36
Portable and Laptop Activation Chart	38
Using Video Mirroring with a PowerBook Computer	43
Projected Image Size	44
Index	45

SAFETY INSTRUCTIONS

Please read and follow all safety instructions provided BEFORE using your new projector. Failure to comply with safety instructions may result in fire, electrical shock, or personal injury and may damage or impair protection provided by equipment. Please save all safety instructions.

Safety Definitions:

- **Warning:** Statements identify conditions or practices that could result in personal injury.
- **Caution:** Statements identify conditions or practices that could result in damage to your equipment.

Safety Symbols:



Attention: For information about usage of a feature, please refer to the User's Guide.



Warning: Hot surface. Do not touch.



An arrow pointing to the lamp door on the projector.

Safety Terms:

- **Warning:** Don't look directly into the lens when the lamp is turned on.
 - **Warning:** To replace the lamp, turn the projector off by unplugging the power cord. To avoid burns, wait 30 minutes before opening the lamp door. Follow all instructions provided in this User's Guide.
 - **Warning:** Please use the power cord provided. Connect the power cord to a receptacle with a protective safety (earth) ground terminal.
- **Warning:** Refer all service to qualified service personnel. Servicing your own projector will void the warranty. See the following page for the customer service contact information.
- **Caution:** Don't block ventilation openings.

- **Caution:** Don't set liquids on the projector. Spilled liquids may damage your projector.
- **Caution:** Don't place the projector on a hot surface or in direct sunlight.
- **Caution:** Do not drop the projector. Transport the projector in an InFocus-approved case; see page 37 for a list of cases.

Important Operating Considerations

Do not place the projector on a tablecloth or other soft covering that may block the vents. In the unlikely event of the bulb rupturing, thoroughly clean the area behind the projector and discard any edible items placed in that area.

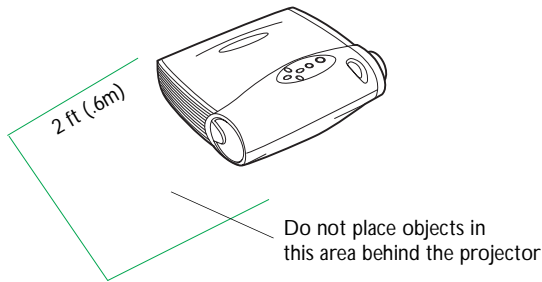

Customer Service

If you need assistance, call Boxlight at 1-800-762-5757 or 360-779-7901.

INTRODUCTION

The Boxlight® XD-5m is specifically designed for the mobile presenter. It packs XGA 1024x768 graphics with 16.7 million colors into a small, 4.8 pound package. It generates crisp, clear images using Digital Light Processing™ (DLP) technology. The XD-5m is easy to connect, easy to use, easy to transport, and easy to maintain.

Image Resolution

The XGA resolution of the XD-5m's projected image is 1024x768. The projector cannot compress screen resolutions above 1024x768. If your computer's screen resolution is higher than 1024x768, reset it to a lower resolution before you connect the projector.

Compatibility

The projector is compatible with a wide variety of computers and video devices, including:

- IBM-compatible computers, including laptops, up to 1024x768 resolution.
- Apple Macintosh and PowerBook computers up to 1024x768 resolution.
- Most standard VCRs, DVD players, camcorders and laser disc players.

Unpacking the Projector

The projector comes with the items shown in Figure 1. Check to make sure all are included. **Contact Boxlight immediately if anything is missing.**

If you are experienced in setting up presentation systems, use the *Quick Start* card that was included in the shipping box. For complete details on connecting and operating the projector, refer to this User's Guide.



***NOTE:** The projector automatically expands 640x480 and 800x600 images to 1024x768. You can display these images at their native resolutions by turning off the Auto Resize feature. See "Auto Resize" on page 21 for more information.*



NOTE: The contents of your shipping box may vary depending on the projector configuration you've ordered.

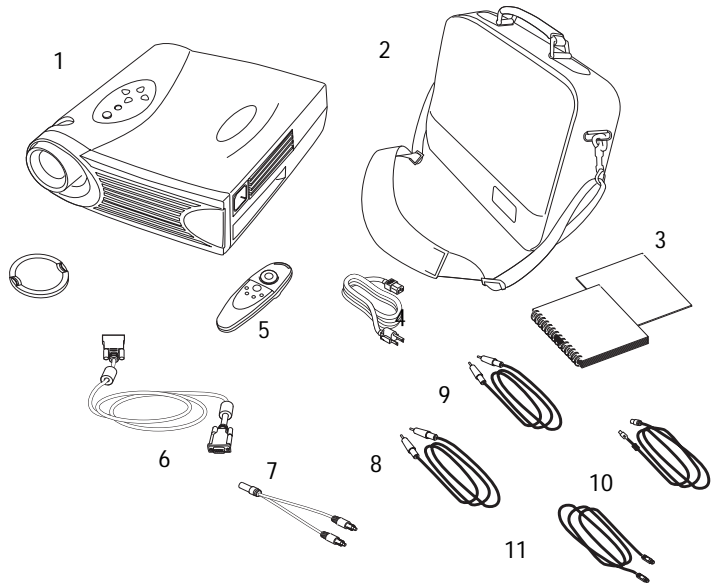

FIGURE 1

Shipping box contents

- | | |
|--------------------------------------|--------------------------|
| 1. XD-5m projector + lens cap | 6. VESA computer cable |
| 2. Soft carry case | 7. Audio cable adapter |
| 3. User's Guide and quick start card | 8. Audio cable |
| 4. Power cord | 9. Composite video cable |
| 5. Remote control | 10. PS/2 mouse cable |
| | 11. USB mouse cable |

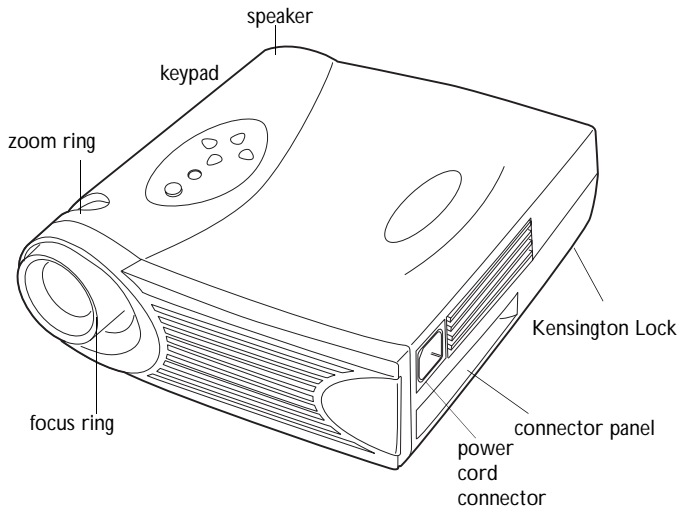

FIGURE 2

Side view of projector

Usage Guidelines

- Do not look directly into the projection lens when the lamp is turned on. The bright light may harm your eyes.
- Do not block the grills on the projector. Restricting the air flow can cause it to overheat and turn off. If this happens, you must wait a minute before attempting to turn it back on.
- Handle the projector as you would any product with glass components. Be especially careful not to drop it.
- Avoid leaving the projector in direct sunlight or extreme cold for extended periods of time. If this happens, allow it to reach room temperature before use.
- Transport the projector in a vendor-approved hard or soft case.

If You Need Assistance

The first place to look for help is in this manual. Be sure to check the guidelines in “Troubleshooting” on page 31.

If this manual doesn't answer your question, call Boxlight at 1-800-762-5757 or 360-779-7901.

Warranty

This product is backed by a limited two-year warranty. The details of the warranty are printed at the back of this manual.

SETTING UP THE PROJECTOR

- 1 Place the projector on a flat surface.
 - The projector must be within 10 feet (3 m) of your power source and within 6 feet (1.8 m) of your computer.
 - If you want to project from behind a translucent screen, set up the projector behind your screen. See “Rear Projection” on page 24 to reverse the image.
- 2 Position the projector the desired distance from the screen.
 - The distance from the lens of the projector to the screen and the zoom setting determine the size of the projected image. Figure 3 shows three projected image sizes. For more information about image size, see “Projected Image Size” on page 44.

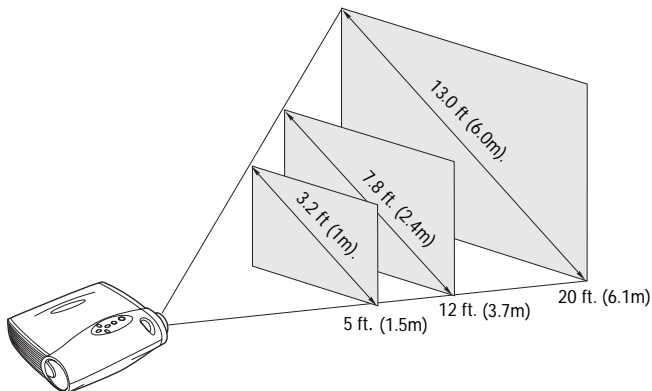

FIGURE 3

Projected image size at minimum zoom

- 3 Make sure the projector is unplugged and your computer is turned off.



NOTE: Before you continue, make sure the projector is unplugged and your equipment is turned off. If you're connecting a computer, make sure the distance between it and the projector is 6 feet or less.

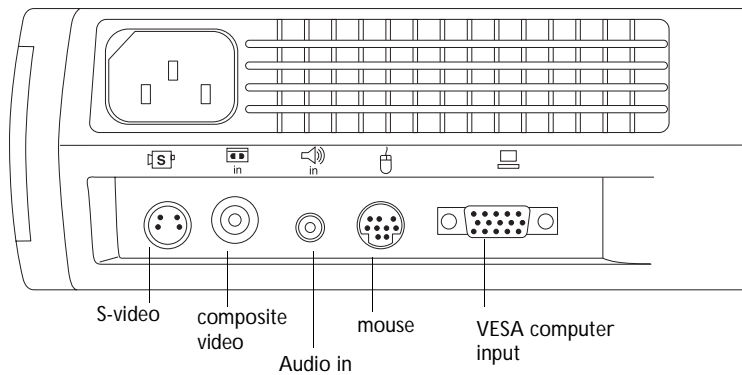



FIGURE 4

Connector panel

Connecting a Computer

- 1 Plug one end of the VESA computer cable into the video connector on your computer.
- 2 Plug the other end of the VESA computer cable into the  connector on the projector.

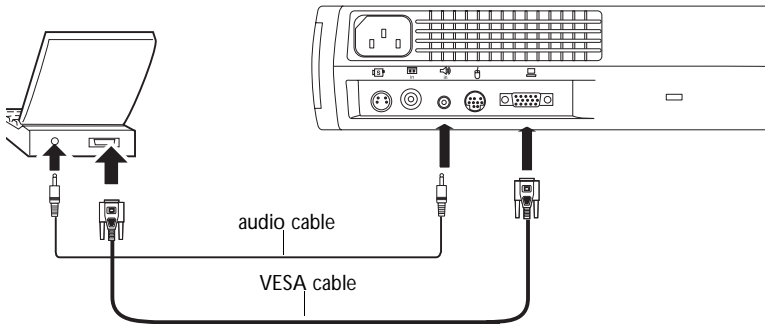



FIGURE 5

Connecting the projector to a computer

Do you want to play your computer's audio on the projector?

- 1 Plug either end of the audio cable into the audio connector on your computer.
- 2 Plug the other end of the audio cable into the  connector on the projector.



NOTE: Many laptop computers do not automatically turn on their external video port when a secondary display device such as a projector is connected. Refer to your computer manual for the command that activates the external video port. Activation commands for some laptop computers are listed in the Appendix of this manual on page 38.





NOTE: If you are connecting an older Macintosh computer that does not have a 15-pin connector, you must use a Mac adaptor between the computer and the projector. See "Optional Accessories" on page 37.

Do you want to control the computer's mouse from the projector's remote or keypad?

If your computer has a PS/2 connector, use the PS/2 mouse cable.

- 1 Plug the end of the PS/2 mouse cable with 6 pins into the mouse connector on your computer.
- 2 Plug the end of the PS/2 mouse cable with 8 pins into the  connector on the projector.

If your computer has a USB connector and is running Windows 98, use the USB mouse cable.

- 1 Plug the  end of the USB mouse cable into the mouse connector on your computer.
- 2 Plug the  end of the USB mouse cable into the  connector on the projector.

You must have the appropriate USB drivers installed on your computer to use the USB feature. Windows 98 ships with the appropriate drivers.

Now you're ready to power up the projector and your laptop. Skip to "Powering up the Projector and Adjusting the Image" on page 11.





NOTE: The USB mouse is supported for use with Windows 98 only.



NOTE: You do not need to restart your computer after connecting a USB mouse to use it (it is hot-pluggable). You must restart your computer after plugging in a PS-2 mouse.

Connecting a Video Player

- 1 If your video player uses a round, one-prong composite video connector, you'll need only the audio cable, audio adapter, and composite video cable that shipped with the projector.
 - If your video player uses a round, four-prong S-video connector, you'll need an S-video cable in addition to the audio cable and audio adapter. The S-video cable is sold separately. (See "Optional Accessories" on page 37.)
- 2 Plug the composite video cable's yellow connector into the "video-out" connector on your video player (Figure 6). This connector may be labeled "To Monitor."
- 3 Plug the other yellow connector into the composite video connector  on the projector.
 - If you're using S-video, plug the other end of the cable into the "S-video" connector  on the projector (Figure 7).

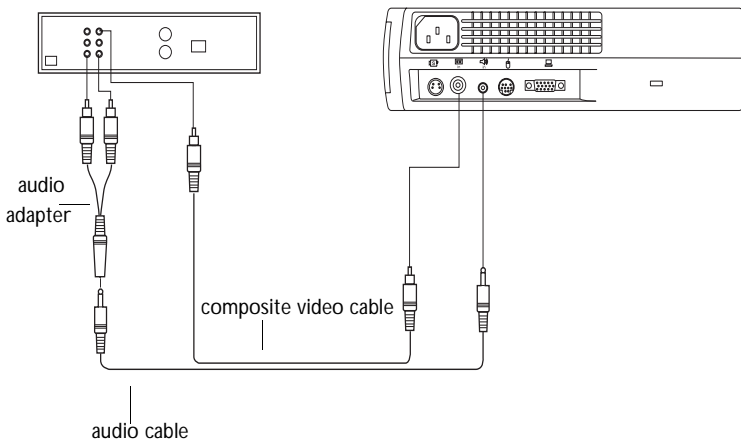

FIGURE 6

Connecting the projector to a video player using the standard video cable (with composite video connector) and the audio cable and adapter

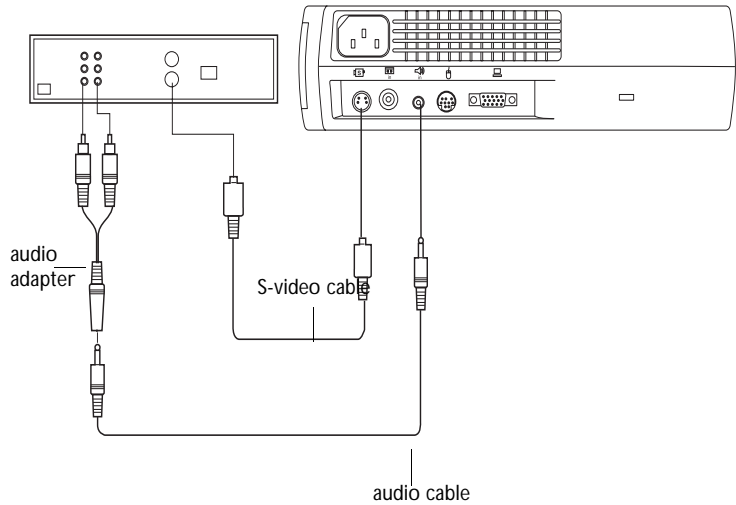



FIGURE 7

Connecting the projector to a video player using an S-video cable and the audio cable and adapter



NOTE: The audio adapter is provided so that the same audio cable used to connect a computer can be used with the adapter to connect a VCR.

- 4 Plug the audio adapter's white connector into the left "audio out" connector on your video player. Plug the adapter's red connector into the right "audio out" connector on the video player (Figure 6 and Figure 7).
- 5 Plug the audio adapter's other end into the audio cable.
- 6 Plug the audio cable into the "audio in"  connector on the projector.

The projector is compatible with these major broadcast video standards: NTSC, NTSC 4.43, PAL, PAL-M, PAL-N, and SECAM. It automatically adjusts to optimize its performance for the incoming video. See "Video Standard" on page 23 for details.



CAUTION: Your video player may also have a "Video Out" connector for a coaxial cable connection. DO NOT use this to connect to the projector.

Powering up the Projector and Adjusting the Image

- 1 Remove the lens cap.
- 2 Plug the power cord into the side of the projector, then plug it into your electrical outlet. A surge-protected power strip is recommended.
 - The fans start to run, and the Lamp LED on the top of the projector (Figure 11 on page 16) lights orange until the software has initialized. When initialization is complete, the Lamp LED lights green. A green Lamp LED indicates that you can press the lamp on/off button to turn the lamp on and off.
- 3 Turn on the lamp by pressing the lamp on/off button  on the keypad (see Figure 11 on page 16).
 - The startup screen appears and the Lamp LED on top of the projector lights green.
- 4 If you connected a video player, turn it on.
 - The video image should display on the projection screen. If a computer source is active, press the source button on the keypad (page 16) or the video button on the remote to display your video image. You can select a default source to determine which source the projector examines first during power-up for active video; see “Default Source” on page 24.
 - Use the volume buttons to adjust the volume.
- 5 Turn on your computer.
 - The computer image should display on the projection screen. If a video source is active, press the source button on the keypad or the computer button on the remote to display your computer’s image. Make sure your laptop’s external video port is activated; see “Portable and Laptop Activation Chart” on page 38 for details.
 - If necessary, make adjustments to the image using the projector’s on-screen menus. To open the menus, press the menu button on the keypad or remote, then select the Display or Image sub-menu. For more information about the menus, see page 18.



NOTE: Always use the power cord that shipped with the projector.



NOTE: With some computers, the order in which you power up the equipment is very important. Most computers should be turned on last, after all other peripherals have been turned on. Refer to your computer’s documentation to determine the correct order.

Turning Off the Projector

If you want to turn off the projector for a short period of time, press the standby button on the keypad or remote. This blanks the screen for fifteen minutes, but keeps the projector running. (You can change the amount of time the projector stays in standby mode; see “Standby Time” on page 23 for details.) After 15 minutes, the lamp goes out (the projector keeps running). To exit standby mode, press the standby button again. (It may take several seconds for the projection lamp to reach full power and project the image again.)



.....

NOTE: Lamp life will be extended if you turn the lamp off, then wait 1 minute while the lamp cools before unplugging the projector. The Lamp LED will light green when the lamp has cooled. See page 16 for details on the Lamp LED.

To completely power off the projector, unplug it. If you want to turn the lamp back on immediately, you must allow about a minute for the lamp to cool. The lamp won't light if it's too hot.

USING THE PROJECTOR

This section describes how to use and make adjustments to the projector. It also provides a reference to the keypad and remote buttons and the options available from the on-screen menus.

Basic Image Adjustment

- 1 Make sure you have powered up your equipment in the right order (page 11).
- 2 If the image doesn't display completely, zoom the image (page 15), adjust the height of the projector (page 15) or center the image by adjusting its horizontal or vertical position (page 22). Be sure the projector is at a 90 degree angle to the screen.
- 3 If the image is out of focus, rotate the focus lens (page 15).
- 4 If the image appears to shimmer or if it has blurry vertical bars after you have adjusted the focus, turn Auto Image (page 21) off and then back on to reset the automatic sync and tracking. If that doesn't clear up the image, turn Auto Image off and adjust the sync (page 21) and/or the tracking (page 22) manually.
- 5 If the colors don't look right, adjust the brightness (page 19).

Using the Remote Control

The projector ships with a remote that has four function buttons, a disk mouse and two mouse buttons, one on the top of the remote and one on the bottom.

Point the remote control at the projection screen or at the front of the projector. The range for optimum operation is about 25 feet. If you point the remote at the projection screen, the distance to the screen and back to the projector must be less than or equal to 25 feet. For best results, point the remote directly at the projector.

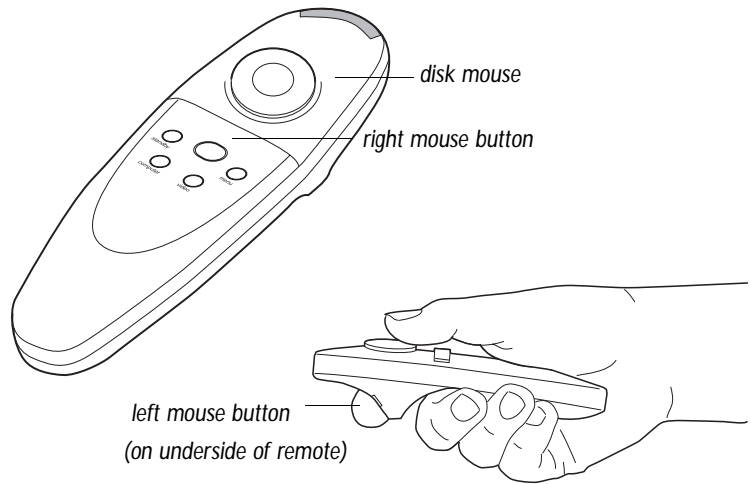

FIGURE 8

Remote control

Press anywhere on the edge of the disk mouse to move the cursor on the screen. You can move the cursor at any angle by pressing the corresponding edge of the disk. The mouse button on the top of the remote simulates your computer’s right mouse button; the button on the bottom simulates your computer’s left mouse button. See “Using the Keypad and Remote Buttons” starting on page 16 for a description of the four function buttons.

If you are creating presentations in Microsoft® PowerPoint®, you can use the remote’s mouse buttons to navigate through your presentation while in Slide Show mode. To configure PowerPoint for this, choose Options from the Tools menu, click the View Tab, de-select the “Popup Menu on Right Mouse Click” option in the Slide Show section, then click OK. Then, when you’re in PowerPoint’s Slide Show mode, a left click advances to the next slide and a right click returns to the previous slide (other PowerPoint modes are not affected).

Adjusting the Projector

To focus the image, rotate the focus ring (Figure 9) until the image is clear. To zoom the image, rotate the zoom ring. This adjusts the image size without affecting focus.

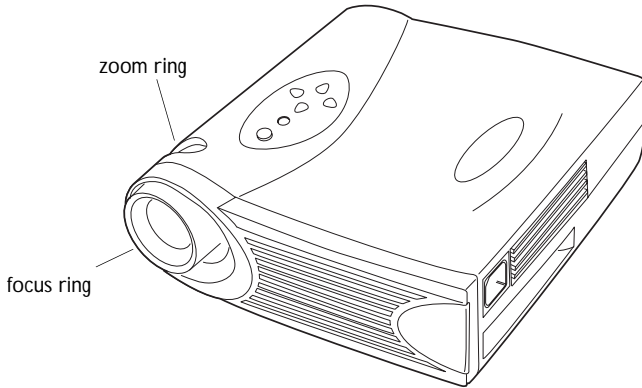

FIGURE 9

Focus ring and zoom ring

The projector is equipped with a self-locking, quick-release elevator foot and button (Figure 10).

To raise the projector:

- 1 Press and hold the elevator button (Figure 10).
- 2 Raise the projector to the height you want, then release the button to lock the elevator foot into position.

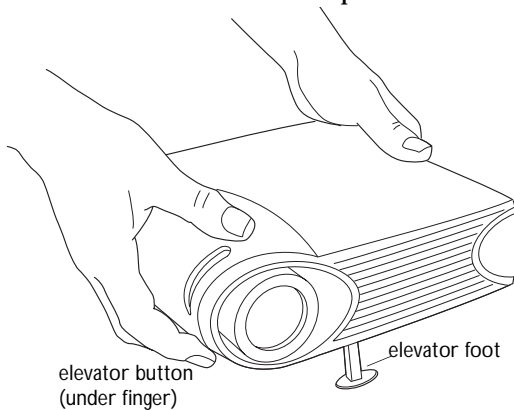

FIGURE 10

Adjusting the height of the projector

Using the Keypad and Remote Buttons

While the menus are displayed, the volume, source, and standby buttons on the keypad act as menu navigation buttons. See “Using the On-Screen Menus” on page 18 for details.

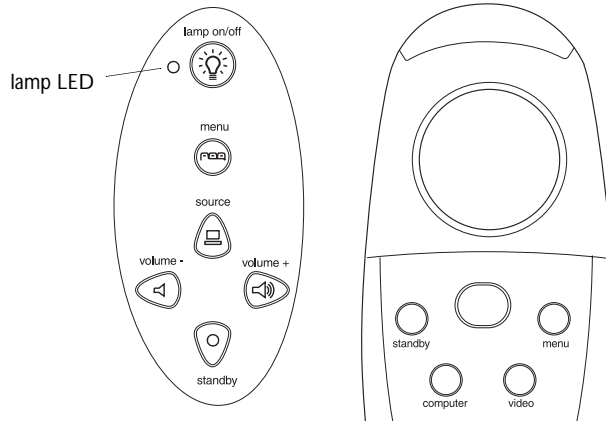

FIGURE 11
Keypad and remote buttons

Lamp on/off (keypad only)

Press the **lamp on/off** button to turn the lamp on or off. The Lamp LED indicates the state of the lamp. A green Lamp LED indicates that you can turn the lamp on, or the lamp is currently on. An orange LED indicates the software is initializing or the lamp is cooling. Do not press the lamp on/off button when the LED is orange.

Menu

Press the **menu** button to open the on-screen menus. Press **menu** again to close the menus. When you close the menus, the projector saves any changes you made. For more information about the on-screen menus, see page 18.

Source (keypad only) or Computer and Video (remote only)



When you have more than one source (computer and video) connected to the projector, select between them by pressing the **source** button on the keypad or the **computer** or **video** button on the remote.

Standby

When you press **standby**, the display and audio turn off and a blank screen is displayed for 15 minutes. You can change the amount of time the projector stays in standby mode; see “Standby Time” on page 23 for details.

- If you press **standby** again within 15 minutes, the projector returns to normal operations immediately.
- If you press **standby** again after 15 minutes, there is about a 60 second delay before the lamp turns back on.
- If you don't press **standby** again, the lamp turns off after 15 minutes.

Volume (keypad only)

To increase the volume, press **volume +** . To decrease the volume, press **volume -** .

Volume adjustments are saved for each source you have connected.



NOTE: Some menu items may be grayed out at certain times. This indicates the item is not applicable to your setup (for example, video standards do not apply to computer sources) or the item is not enabled until another selection is made (for example, Manual Tracking is not available until Auto Image is turned off).

Using the On-Screen Menus

The projector has six drop-down menus that allow you to make image adjustments and change a variety of settings. Most of these adjustments aren't available directly from the keypad.

To open the on-screen menus, press the menu button on the keypad or remote. This changes the volume, source, and standby buttons on the keypad to menu navigation buttons. Press the corresponding buttons to move the cursor up, down, left, or right, or use the disk mouse on the remote. To select a menu, move the cursor left and right to highlight the menu you want. The drop-down menu appears.

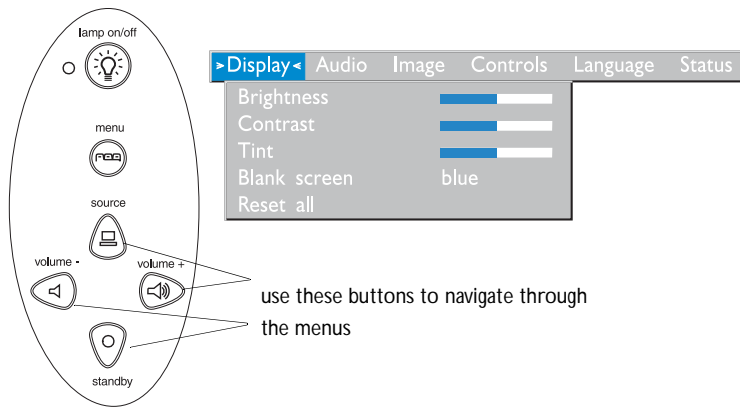

FIGURE 12

Keypad navigation buttons and drop-down menu

To change a menu setting, use the up and down navigation buttons on the keypad or the disk mouse on the remote to move the cursor up and down to the item you want to change (the selected item is highlighted), then use the left and right navigation buttons to adjust a setting. Some submenus, such as Brightness, consist of a slider bar you use to increase or decrease a value; some submenus, such as Standby Time, consist of options you scroll through to select the desired one. All changes are saved when you close the menus.

To access another menu, use the up and down navigation buttons or the disk mouse to move back to the top of the current menu, then use the left and right navigation buttons to move to another menu.

Display Menu

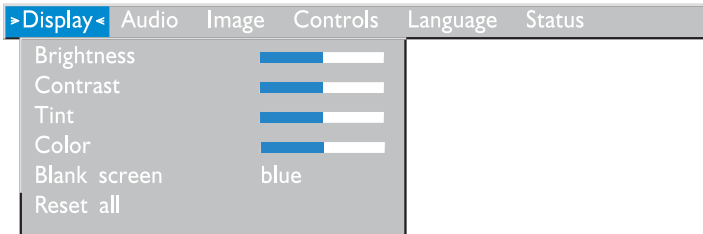

FIGURE 13

Display menu

Brightness

Adjusting the brightness changes the intensity of the image.

- Press the left navigation button to darken the image.
- Press the right navigation button to lighten the image.

Contrast

The contrast controls the degree of difference between the lightest and darkest parts of the picture. Adjusting the contrast changes the amount of black and white in the image.

- Press the left navigation button to decrease the contrast.
- Press the right navigation button to increase the contrast, making the blacks appear blacker and the whites appear whiter.

Tint

The tint adjusts the red-green color balance in the projected image. Changing the Tint setting has no effect on PAL or SECAM video sources.

- Press the left navigation button to increase the amount of green in the image.
- Press the right navigation button to increase the amount of red in the image.

Color

The color setting adjusts a video image from black and white to fully saturated color. This setting is not available for computer images.

- Press the left mouse button to decrease the amount of color in the image.
- Press the right mouse button to increase the amount of color in the image.

Blank Screen

Blank Screen determines what color is displayed when there is no active source and when the projector is in standby. Click the left or right navigation button to toggle between blue and black.

Reset All

Click the left or right navigation button to reset all the options (except Language, Video Standard, Rear Projection, and Standby Time) in all the menus to their original settings.

Audio Menu



FIGURE 14

Audio menu

Volume

- Press the left navigation button to decrease the volume.
- Press the right navigation button to increase the volume.

Volume adjustments you make are saved for each source.



NOTE: Changing the volume using the menu is the same as changing it using the keypad.

Image Menu

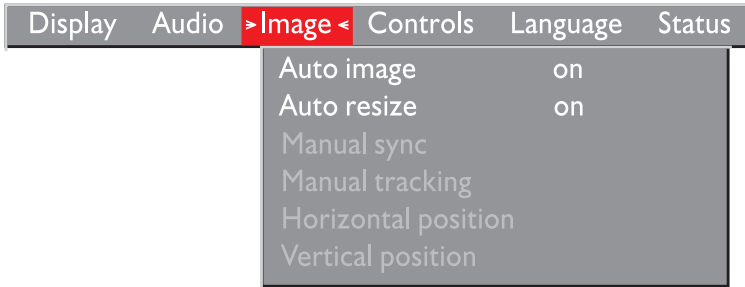

FIGURE 15

Image menu

Auto Image

The projector automatically adjusts tracking, signal synchronization and vertical and horizontal position for most computers (Auto Image does not apply to video sources). If you want to adjust these features manually, you must turn off **Auto Image** first by highlighting Auto Image in the Image menu and clicking the left or right navigation button to select “off”.

Auto Resize

Auto Resize automatically resizes the image by scaling it up. It only affects computer images that are not the projector’s native resolution.

When **Auto Resize** is on, the projector makes the best fit of the image to the screen. If you turn **Auto Resize** off (by highlighting it in the Image menu and clicking the left or right navigation button to select “off”), the image may be either cropped or too small for the screen.

Manual Sync

The projector adjusts signal synchronization automatically for most computers. But if the projected computer image looks fuzzy or streaked, try turning **Auto Image** off then back on again. If the image still looks bad, try adjusting the signal synchronization manually:



NOTE: Some screen savers interfere with the operation of Auto Image. If you’re experiencing problems, try turning your screen saver off, then turning Auto Image off and back on.

- 1 Turn Auto Image off.
- 2 Highlight Manual sync, then press the left or right navigation button repeatedly until the image is sharp and free of streaks.

Manual Tracking

The projector adjusts tracking automatically to match the video signal from your computer. However, if the display shows evenly spaced, fuzzy, vertical lines or if the projected image is too wide or too narrow for the screen, try turning **Auto Image** off then back on again. If the image is still bad, try adjusting the tracking manually:

- 1 Turn Auto Image off.
- 2 Highlight Manual tracking, then press the left or right navigation button repeatedly until the fuzzy vertical bars are gone.

Horizontal position

Follow these steps to manually adjust the horizontal position:

- 1 Turn Auto Image off.
- 2 Highlight Horizontal position, then press the left navigation button to move the image right or press the right navigation button to move the image left.

Positioning adjustments are saved when you power off the projector.

Vertical position

Follow these steps to manually adjust the vertical position.

- 1 Turn Auto Image off.
- 2 Highlight Vertical position, then press the left navigation button to move the image down or press the right navigation button to move the image up.

Positioning adjustments are saved when you power off the projector.



NOTE: *The Manual Sync, Manual Tracking, Horiz.*

Position and Vert. Position
options are available only for computer sources. The projector sets these options automatically for video source.s

Controls Menu

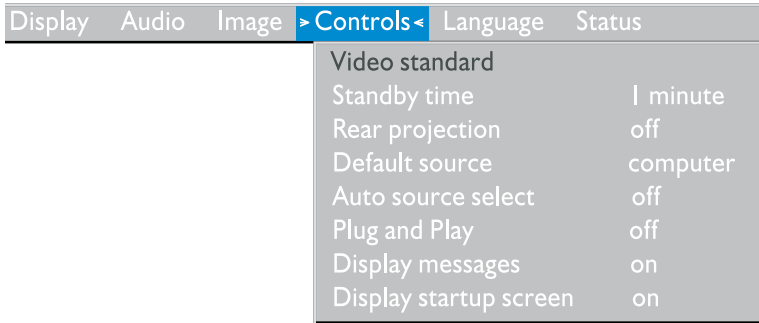

FIGURE 16

Controls menu

Video Standard

When Video standard is set to Auto, the projector attempts to pick the video standard (NTSC, NTSC 4.43, PAL, PAL-M, PAL-N, or SECAM) automatically based on the input signal it receives. (The video standard options may vary depending on your region of the world.) If the projector is unable to detect the correct standard, the colors might not look right or the image might appear “torn.” If this happens, manually select a standard by clicking the left or right navigation button and cycling through the standards.

Standby Time

This option lets you select how long the lamp stays on and the blank screen is displayed when the projector enters standby mode before the projector turns off. Select among 1, 5, 10, and 15 minutes and 1 and 2 hours by clicking the left or right navigation button and cycling through the options.



NOTE: If you already know the video standard used in your geographical area, it's often best to manually select it.

Rear Projection

When you turn **Rear Projection** on, the projector reverses the image so you can project from behind a translucent screen. Highlight **Rear Projection**, then click the left or right navigation button to turn this feature on and off.

Default Source

Default Source toggles between **Computer** and **Video**. This determines which source the projector checks first for active video during power-up. Highlight **Default Source** and click the left or right navigation button to toggle between the options.

Auto Source Select

This setting toggles between **On** and **Off**. When this feature is **Off**, the projector defaults to the source selected in **Default Source**. To display another source, you must manually select one by pressing the source button on the keypad or the **computer** or **video** button on the remote. When this feature is **On**, the projector automatically finds the active source, checking the default source first. Highlight **Auto Source Select** and click the left or right navigation button to turn this feature on and off.

Plug and Play

This setting toggles between **On** and **Off**. When it is **On**, most new computers will automatically recognize the projector, then set the monitor resolution and refresh rate accordingly. You need to set the **Plug and Play** setting to **Off** for the projector to display properly on some older computers. The **Plug and Play** setting does not affect video images.

If the projector's display constantly changes between the computer image and the message, "Perfecting the image", you may need to turn **Plug and Play** **Off**.

Display Messages

This setting toggles between **On** and **Off**. When this feature is **On**, status messages such as "No signal detected" or "Standby Active" appear in the lower-right corner of the screen. Click the left or right navigation button to turn this feature off and not see status messages.

Display Startup Screen

This setting toggles between On and Off. When this feature is On, the startup screen appears when the projector starts up and remains until an active source is detected. The startup screen contains information on contacting Boxlight. Click the left or right navigation button to turn this feature off and display a plain black or blue screen instead of the startup screen.

Language Menu



FIGURE 17

Language menu

You can display the on-screen menus in English, French, German, and Spanish.

- Move the cursor to the language you want, then click the left or right navigation button. The menus redraw immediately.

Status Menu

This is a read-only window for informational purposes. To display the status window, select Show status from the menu, then click the left or right navigation button. To remove the window, click the left or right navigation button.

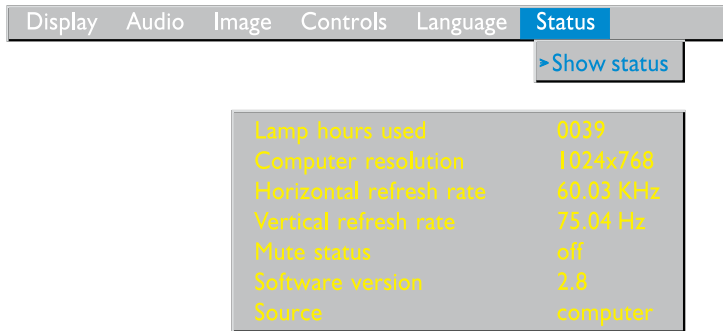

FIGURE 18

Status menu

Lamp hours used

Indicates how many hours the current lamp has been in use. The counter starts at zero hours and counts each hour the lamp is in use. Change the bulb when the brightness is no longer acceptable. See “Replacing the Projection Lamp” on page 27 for details.

Computer resolution

Shows your computer’s resolution setting. To change this, go to your computer’s Control Panel and adjust the resolution in the Display tab. See your computer’s user’s guide for details.

Horizontal refresh rate

The time period that one horizontal line is displayed.

Vertical refresh rate

The time period that one video frame is displayed.

Mute status

Indicates if the audio is muted.

Software version

Indicates the projector’s software version. This information is useful when contacting Technical Support.

Source

Indicates the active source, Computer or Video.

MAINTENANCE & TROUBLESHOOTING

This section describes how to:

- clean the lens
- replace the projection lamp
- replace the batteries in the remote
- use the Kensington lock feature
- troubleshoot the projector

Cleaning the Lens

Follow these steps to clean the projection lens:

- 1 Apply a non-abrasive camera lens cleaner to a soft, dry cloth.
 - Avoid using an excessive amount of cleaner.
 - Abrasive cleaners, solvents or other harsh chemicals might scratch the lens.
- 2 Lightly wipe the cleaning cloth over the lens in a circular motion.
- 3 If you don't intend to use the projector immediately, replace the lens cap.

Replacing the Projection Lamp

The lamp hour counter in the Status menu counts the number of hours the lamp has been in use. Replace the lamp when the brightness is no longer acceptable. You can order new lamp modules from you Boxlight. See “Accessories” on page 36 for information.

Follow these steps to replace the projection lamp:

- 1 Turn off the projector by unplugging the power cord.
- 2 Wait 30 minutes to allow the projector to cool thoroughly.
- 3 Invert the projector on a flat surface, then insert a small screwdriver or other flat object into the tab on the lamp module door (Figure 19).



WARNING: To avoid burns, allow the projector to cool for at least 30 minutes before you open the lamp module door. Never extract the lamp module while the lamp is operating.



WARNING: Be extremely careful when removing the lamp module. In the unlikely event that the bulb ruptures, small glass fragments may be generated. The lamp module is designed to contain these fragments, but use caution when removing the lamp module.

4 Pull the lamp door up and remove it.

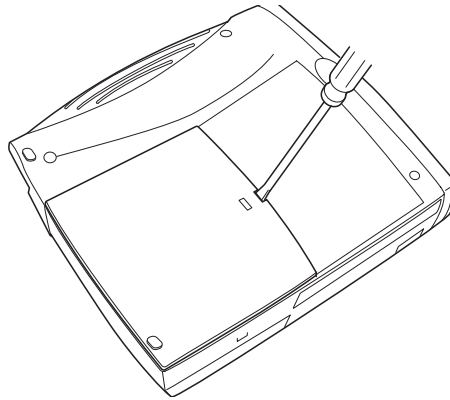

FIGURE 19

Removing the lamp door



CAUTION: Never operate the projector with the lamp door open or removed. This disrupts the air flow and causes the projector to overheat.

5 Loosen the two non-removable screws on the outside of the module.

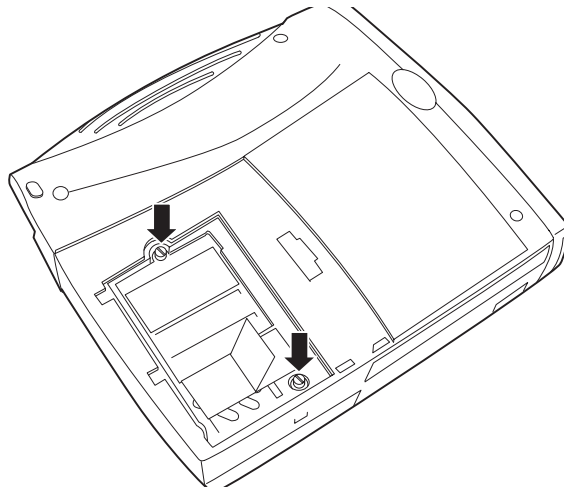

FIGURE 20

Loosening the screws on the lamp module

6 Lift and grasp the pull tab and lift the module out (Figure 21).

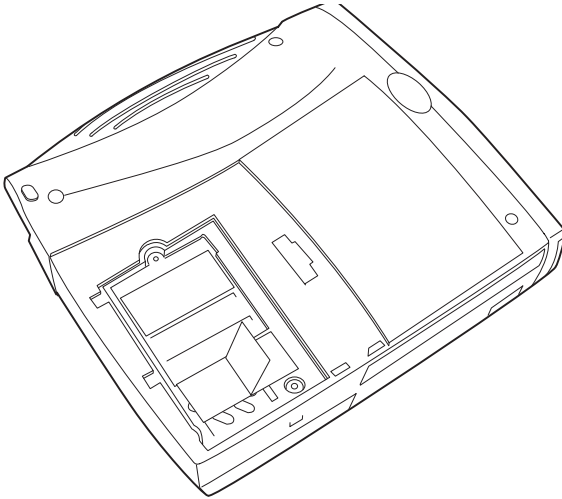

FIGURE 21

Removing the lamp module

- 7 Install the new lamp module, being sure to align the connectors properly.
- 8 Gently push the module in until it is flush with the bottom case of the projector.
- 9 Tighten the screws on the outside of the module.
- 10 Replace the lamp door by inserting the hooks on the rear of the lamp door into the projector and pressing the lamp door into place.
- 11 Plug in the power cord to turn the projector back on.
- 12 To reset the lamp hour counter in the Status window, press and hold the volume - button, then press the menu button (while still holding down the volume - button) for 5 seconds. Verify that the counter was reset by pressing the menu button and viewing the counter in the Status window.



WARNING: Do not drop the lamp module or touch the glass bulb! The glass may shatter and cause injury.

Replacing the Batteries in the Remote Control

The life of the batteries depends on how often and how long you use the remote. Symptoms of low battery charge include erratic responses when using the remote and a reduced range of operation.

Follow these steps to replace the batteries:

- 1 Turn the remote face down in your hand.
- 2 Slide the battery cover off the end of the remote.
- 3 Remove the old batteries and dispose of them in an environmentally proper manner.
- 4 Install two new AAA alkaline batteries. Make sure you install each in the correct direction.
- 5 Slide the battery cover back on the remote.

Using the Kensington Lock

The projector has a Kensington Security Standard connector for use with a Kensington MicroSaver Security System (Figure 22). See “Optional Accessories” on page 37 for ordering information. Refer to the information that came with the Kensington System for instructions on how to use it to secure the projector.

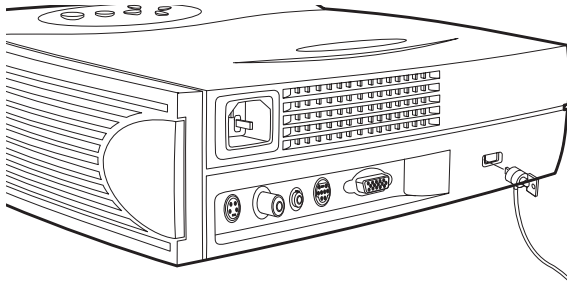

FIGURE 22

Installing the Kensington lock

Troubleshooting

Problem: Nothing on projection screen

- Make sure that the power cord is properly connected to a fully functional AC electrical outlet. Make sure that the power cord is also properly connected to the projector.
- If the projector is plugged into a power strip, make sure the power strip is turned on.
- Make sure you have removed the lens cap on the projection lens at the front of the projector.
- Make sure the lamp is switched on.
- Check the projector's lamp to ensure that it is securely connected in the lamp module. See "Replacing the Projection Lamp" on page 27.
- Make sure that the cables do not have any bent pins.

Problem: Color or text not being projected

- You might need to adjust the brightness up or down until the text is visible. Refer to "Brightness" on page 19 for more information.

Problem: The screen resolution is not right

- Make sure the computer's video card is set for a resolution of no greater than 1024x768.

Problem: Image isn't centered on the screen

- Reposition the image. Refer to "Horizontal position" on page 22 and "Vertical position" on page 22.
- Be sure the projector is at a 90 degree angle to the screen.

Problem: Only the start-up screen displays

- Verify that the cables are connected correctly. See page 7 through page 8 for connection procedures.
- Verify that the proper input source is connected. See "Source (keypad only) or Computer and Video (remote only)" on page 16.

- You might need to turn everything off and power up the equipment again in the proper order. Refer to your computer's documentation to determine the correct order.
- Make sure your laptop's external video port is turned on. See the "Portable and Laptop Activation Chart" on page 38 or your computer's manual for details.
- Make sure your computer's video board is installed and configured correctly.
- Make sure your computer has a compatible video board. The projector isn't CGA, EGA or SXGA compatible.

If you're using Windows 98:

- 1 Open "My Computer" icon, the Control Panel folder and then the Display icon.
- 2 Click the Settings tab.
- 3 Verify that the Desktop area is set to 1024x768 or less.

Problem: Image is too wide or narrow for screen

- Adjust the zoom or projector placement.
- Adjust the resolution of your video card if it's greater than 1024x768.

Problem: Image is out of focus

- Turn the projection lens to focus the image.
- Make sure the projection screen is at least 5 feet (1.5 m) from the projector.
- Check the projection lens to see if it needs cleaning.

Problem: Image and menus are reversed left to right

- Rear projection mode is probably turned on. Turn Rear Projection off in the Controls menu. The image should immediately return to forward projection. See “Rear Projection” on page 24.

Problem: the projector displays vertical lines, “bleeding” or spots

- Adjust the brightness. See “Brightness” on page 19.
- Check the projection lens to see if it needs cleaning.

Problem: no sound

- Adjust volume.
- Verify audio/input connections.
- Adjust audio source.

Problem: Image is “noisy” or streaked

Try these steps in this order.

- 1 Deactivate the screen saver on your computer.
 - 2 Turn **Auto Image** off and then back on again. See “Auto Image” on page 21.
 - 3 Turn **Auto Image** off and adjust the synchronization and tracking manually to find an optimal setting. See “Manual Sync” on page 21 and “Manual Tracking” on page 22.
- The problem could be with your computer’s video card. If possible, connect a different computer.

Problem: Projected colors don't match the computer or video player's colors

- Just as there are differences in the displays of different monitors, there are often differences between the computer image and the projected image. Adjust the brightness, tint and/or contrast from the Display menu. See "Brightness" on page 19, "Contrast" on page 19 and "Contrast" on page 19.

Problem: Lamp seems to be getting dimmer

- The lamp begins to lose brightness when it has been in use for a long time. Replace the lamp as described in "Replacing the Projection Lamp" on page 27.

Problem: Lamp shuts off

- A minor power surge may cause the lamp to shut off. Unplug the projector, wait at least a minute, then plug it back in.
- Make sure the vents are not blocked.

Before calling Boxlight for assistance, please have the following information available:

- the projector's serial number (located on the bottom label)
- the resolution of your computer.

Call Boxlight at 1-800-762-5757 or 360-779-7901.

APPENDIX

Specifications

The XD-5m must be operated and stored within the temperature and humidity ranges specified.

Temperature

Operating	50 to 104° F (10 to 40° C)
Non-operating	-4 to 158° F (-20 to 70° C)

Humidity

Operating and non-oper.	5% to 95% relative humidity, non-condensing
-------------------------	---

Dimensions

8.9 x 10 x 2.8 inches (22.6 x 25.4 x 7.1 cm)

Weight

4.8 lbs. (2.2 kg) unpacked

Altitude

Operating	0 to 10,000 feet (3,048 meters)
Non-operating	0 to 40,000 feet (12,192 meters)

Optics

Focus Range	4.9 - 16 feet (1.5-5 m)
-------------	-------------------------

Lamp

Type	120-watt VIP lamp
------	-------------------

Input Power Requirements

100-120VAC 6A; 50/60Hz
200-240VAC 3A; 50Hz

Audio Input

Input Impedance	10K ohm nominal, AC coupled
Maximum Input Voltage	$(L_{IN} + R_{IN})_{PEAK} < 4.5 \text{ V}$ for $THD \leq 0.3\%$ L_{IN} or $R_{IN} < 2.0 \text{ V}_{rms}$ for $THD \leq 0.3\%$
Sensitivity	100 mV at 1 KHz for 88 dB SPL at 1 meter
Connector Type	3.5 mm (1/8 inch) stereo phone mini

Accessories

Standard Accessories (ship with the projector)

Quick Start card

User's Guide

Soft Case

Shipping Box

VESA Computer Cable

Composite Video Cable

Computer Audio Cable 6 ft (1.8 m)

Audio Adapter (RCA to 3.5mm)

PS/2 Mouse Cable

USB Mouse Cable

Executive Remote Plus

Projection Lamp Module

Lens Cap



NOTE: Use only Boxlight-approved accessories. Other products have not been tested with the projector.

Power Cords (one ships with projector, type depends on country)

North American Power Cord

Australian Power Cord

UK Power Cord

European Power Cord

Danish Power Cord

Swiss Power Cord

Optional Accessories

Deluxe Carry Case

Shipping Case (ATA approved)

Deluxe Travel Case

Macintosh Adaptor

Full-Feature Laser Pro Remote Control

GyroPoint II Radio Frequency Remote

2-Button Executive Remote



Remote Receiver

Kensington MicroSaver Security System

S-Video Cable

3rd Year Advantage Service Plan
(1 year extension)

Portable and Laptop Activation Chart

Many laptop computers do not automatically turn on their external video port when a projector is connected. Activation commands for some laptop computers are listed in the following table. (If your computer is not listed or the given command does not work, refer to the computer's documentation for the appropriate command.) On many laptops, the activation function key is labeled with an icon, for example / or the text CRT/LCD.



NOTE: Usually, pressing the key commands once activates the external video port, pressing it again activates both the external and internal ports, and pressing it a third time activates the internal port. Refer to your computer's documentation for details on your specific model.

Computer	Key command to activate port	Key command to de-activate port
Acer	Ctrl-Alt-Esc (for setup)	Ctrl-Alt-Esc (for setup)
AST* **	FN-D or Ctrl-D Ctrl-FN-D FN-F5 type from A:/VGA/CRT FN-F12	FN-D or Ctrl-D Ctrl-FN-D FN-F5 type from A:/VGA/CRT FN-F12
AMS	FN-F2	FN-F2
AMT	setup screen	setup screen
AT&T	FN-F3 FN-F6	FN-F3 FN-F6
Advanced Logic Research	Ctrl-Alt-V	Ctrl-Alt-V
Altima	Shift-Ctrl-Alt-C setup VGA/ Conf.Simulscan	Shift-Ctrl-Alt-L setup VGA/ Conf.Simulscan
Ambra**	FN-F12 FN-F5 F2/Choose Option/F5	FN-F12 FN-F5 F2/Choose Option/F5
Amrel* **	setup menu Shift-Ctrl-D	setup menu Shift-Ctrl-D
Apple	see Mac Portable and Mac PowerBook	
Aspen	automatic	automatic
Award	FN-F6	FN-F6
BCC*	automatic	reboot computer

Computer	Key command to activate port	Key command to de-activate port
Bondwell	LCD or CRT options after bootup	reboot for LCD or CRT options to appear
Chaplet**	setup screen FN-F6 FN-F4	setup screen FN-F6 FN-F4
Chembook	FN-F6	FN-F6
Commax	Ctrl-Alt-#6	Ctrl-Alt-#5
Compaq* **	Ctrl-Alt-< FN-F4 automatic mode/? (for setup option)	Ctrl-Alt-> FN-F4 automatic mode/? (for setup option)
Compuadd* **	automatic Alt-F for screen setup option	automatic Alt-F for screen setup option
Data General	Ctrl-Alt-Command	Ctrl-Alt-Command
Data General Walkabout	2 CRT/X at DOS prompt	reboot
Datavue	Ctrl-Shift-M	Ctrl-Shift-M
DEC**	FN-F5 FN-F4	FN-F5 FN-F4
Dell**	Ctrl-Alt-< Ctrl-Alt-F10 FN-F8 (CRT/LCD) FN-D FN-F12	Ctrl-Alt-> Ctrl-Alt-F10 FN-F8 FN-D FN-F12
Digital*	automatic FN-F2	reboot FN-F2
Dolch	dip switch to CRT	dip switch to LCD
Epson	dip switch to CRT	dip switch to LCD
Everex*	setup screen option	setup screen option
For-A	Ctrl-Alt-Shift-C	Ctrl-Shift-Alt-L
Fujitsu	FN-F10	

Computer	Key command to activate port	Key command to de-activate port
Gateway	FN-F3 FN-F1/FN-F1 again simultaneous	FN-F3 FN-F1
Grid* **	FN-F2, choose auto or simultaneous Ctrl-Alt-Tab	FN-F2 Ctrl-Alt-Tab
Hitachi	FN-F7	FN-F7
Honeywell	FN-F10	FN-F10
Hyundai	setup screen option	setup screen option
IBM 970*	automatic	warm reboot
IBM ThinkPad**	reboot, enter setup menu FN-F7, select choice from setup menu FN-F1, select choice FN-F5, select choice PS/2 SC select choice (CRT, LCD, etc.)	FN-F2
Infotel	FN-F12	FN-F12
Kaypro	boot up, monitor plugged in	unplug monitor
Kris Tech	FN-F8	FN-F8
Leading Edge	FN-T	FN-T
Mac Portable 100	no video port: not compatible	
Mac PowerBook 140, 145, 150, 170	no video port: requires a 3rd-party interface	
160, 165, 180, 520, 540, 5300	Control Panel folder, PowerBook Display folder; Activate Video Mirroring	warm reboot
210, 230, 250, 270, 280, 2300	requires Apple Docking Station or Mini Dock	
Magitronic	FN-F4	FN-F4
Mastersport	FN-F2	FN-F1

Computer	Key command to activate port	Key command to de-activate port
Micro Express*	automatic	warm reboot
Micron	FN-F2	FN-F2
Microslate*	automatic	warm reboot
Mitsubishi	SW2 On-Off-Off-Off	SW2 Off-On-On-On
NCR	setup screen option	setup screen option
NEC* **	setup screen option CRT at the DOS prompt FN-F3	setup screen option LCD at the DOS prompt FN-F3
Olivetti*	automatic FN-O/*	automatic FN-O/*
Packard Bell* **	FN-F0 Ctrl-Alt-<	FN-F0 Ctrl-Alt->
Panasonic	FN-F2	FN-F2
Prostar	Ctrl-Alt-S at bootup	Ctrl-Alt-S at bootup
Samsung*	setup screen option	setup screen option
Sanyo	setup screen option	setup screen option
Sharp	dip switch to CRT	dip switch to LCD
Sun SPARC-Dataview	Ctrl-Shift-M	Ctrl-Shift-M
Tandy**	Ctrl-Alt-Insert setup screen option	Ctrl-Alt-Insert setup screen option
Tangent	FN-F5	FN-F5
Texas Instruments*	setup screen option	setup screen option
Top-Link* **	setup screen option FN-F6	setup screen option FN-F6
Toshiba* **	Ctrl-Alt-End FN-End FN-F5 setup screen option	Ctrl-Alt-Home FN-Home FN-F5 setup screen option
Twinhead*	FN-F7 FN-F5 Automatic	FN-F7 FN-F5 Automatic
WinBook	Ctrl-Alt-F10	Ctrl-Alt-F10

Computer	Key command to activate port	Key command to de-activate port
Wyse	software driven	software driven
Zenith**	FN-F10	FN-F10
	FN-F2	FN-F2
	FN-F1	FN-F1
Zeos**	Ctrl-Shift-D	Ctrl-Shift-D
	FN-F1	FN-F1

* These manufacturers have models that automatically send video to the external CRT port when some type of display device is attached.

** These manufacturers offer more than one key command depending on the computer model.

Using Video Mirroring with a PowerBook Computer

When you turn video mirroring (called SimulScan in newer PowerBooks—see below) on, the projector displays the same information that appears on your PowerBook's built-in screen. When video mirroring is off, the projector acts like a separate display.

To turn on video mirroring for the first time:

- 1 Open the Monitors control panel; click on Monitor 2.
- 2 Set the number of colors you want.
- 3 Open the Control Strip, then click on the monitor icon.
- 4 Select "Turn Video Mirroring On."

Now you can turn video mirroring on and off from the Control Strip without having to open the Monitors control panel again.

When using video mirroring and high color graphics such as slide shows, the projected image occasionally might turn black and white. If this happens, perform the following steps:

- 1 Turn off video mirroring.
- 2 Open the Monitors control panel.
- 3 Move the white menu bar to Monitor 2 to set the projector as the primary monitor.
- 4 Restart the PowerBook.

Using SimulScan

Some newer PowerBooks display images on an external monitor or projector differently than previous ones. When using SimulScan, the projector displays the same information that appears on your PowerBook

To select SimulScan:

- 1 Open the Control Panel, then double-click Monitors and Sound.
- 2 In the Resolution list, choose the SimulScan mode, then click OK.
- 3 If this changes your display settings, a dialog box appears. Click OK to confirm the change.



Projected Image Size

NOTE: Use the graph and tables to help you determine projected image sizes.

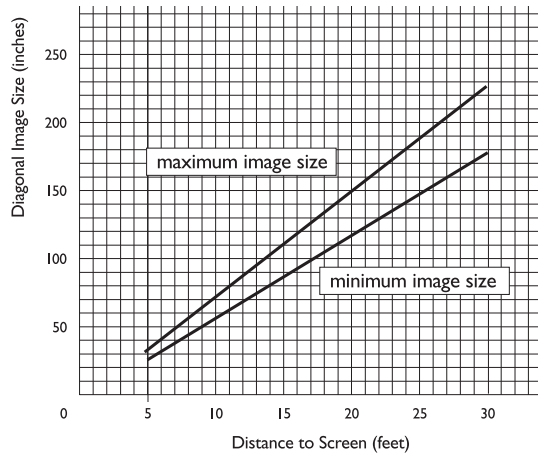

FIGURE 23
Projected image size

Table 1:
Image Size, Width and Height for XD-5m-maximum image size

Distance to Screen (ft/m)	Diagonal (ft/m)	Width (ft/m)	Height (ft/m)
4.9/1,5	3.2/1	2.6/.8	1.9/.6
8/2,4	5.2/1.6	4.2/1.3	3.1/.9
12/3,7	7.8/2.4	6.3/1.9	4.7/1.4
16/4,9	10.4/3.2	8.3/2.5	6.3/1.9
20/6,1	13.0/4	10.4/3.2	7.8/2.4
30/9,1	19.5/5.9	15.6/4.8	11.7/3.6

Table 2:
Image Size, Width and Height for XD-5m-minimum image size

Distance to Screen (ft/m)	Diagonal (ft/m)	Width (ft/m)	Height (ft/m)
4.9/1,5	2.5/.8	2.0/.6	1.5/.5
8/2,4	4.1/1.3	3.3/1	2.5/.8
12/3,7	6.2/1.9	4.9/1.5	3.7/1.1
16/4,9	8.2/2.5	6.6/2	4.9/1.5
20/6,1	10.3/3.1	8.2/2.5	6.2/1.9
30/9,1	15.4/4.7	12.3/3.8	9.2/2.8

INDEX

A

- accessories, ordering 36, 37
- activation commands for laptop computers 38
- adjusting
 - brightness 19
 - contrast 19
 - tint 19
 - volume 17, 20
- adjusting the height of the projector 15
- altitude limits 35
- assistance. See Technical Support
- Audio menu 20
- Audio menu options
 - Volume 20
- Auto Source Select 24

B

- Blank Screen 20
- brightness, adjusting 19
- buttons on keypad
 - Lamp on/off 16
 - Menu 16
 - Source 16
 - Standby 17
 - Volume 17

C

- cables
 - audio 7
 - composite video 9
 - mouse 8
 - ordering 36
 - power 36
 - S-video 9, 37
- cases, ordering 36
- cleaning the projection lens 27
- colors
 - don't match monitor colors 34
 - not displayed 31

- compatibility
 - IBM-compatible 1
 - Macintosh 1
- composite video cable
 - connecting 9
- computers, compatible 1
- connecting
 - IBM-compatible computer 7
 - mouse 8
 - power cord 11
 - video player 9–10
- contrast, adjusting 19
- Controls menu 23
- Controls menu options
 - Auto Source Select 24
 - Default Source 24
 - Display Messages 24
 - Display Startup Screen 25
 - Plug and Play 24
 - Rear Projection 24
 - Standby Time 23
 - Video Standard 23

D

- Default Source 24
- Display menu 19
- Display menu options
 - Blank Screen 20
 - Brightness 19
 - Contrast 19
 - Reset All 20
 - Tint 19
- Display Messages 24
- Display Startup Screen 25
- displaying
 - on-screen menus 16
 - startup screen 25
 - status messages 24

E

elevator button/foot 15

F

fuzzy lines 22

I

IBM-compatible computers

compatibility 1

connecting 7

image

adjusting 11, 13

centering 22

colors don't match computer's 34

focusing 15

fuzzy lines 22

has lines or spots 33

not centered 31

not displayed 31

out of focus 33

quality 31–34

resolution 1

reversed 24, 33

size 5, 44

streaked 33

too wide or too narrow 32

zooming 15

Image menu 21

Image menu options

Auto Image 21

Auto Resize 21

Horiz. Position 22

Manual Sync 21

Manual Tracking 22

Vert. Position 22

K

Kensington lock 30, 37

keypad 16

L

lamp

ordering 36

replacing 27

turns off unexpectedly 34

lamp hour counter 26

Lamp on/off button 16

Language menu 25

language, selecting for menus 25

laptop computers

activation sequence to allow

secondary display 38

compatibility 7

connecting IBM-compatible 7

lens

cap 36

cleaning 27

M

Macintosh computers

compatibility 1

connecting 7

Menu button 18

menus. See on-screen menus

monitor, projected colors don't match

34

mouse, connecting 8

N

NTSC video 23

O

on-screen menus

Audio menu 20

changing language of 25

Controls menu 23

Display menu 19

displaying 18

Image menu 21

Language menu 25

making changes to menu

functions 18

Status menu 26

P

- PAL video 19, 23
- Plug and Play 24
- power cord
 - connecting 11
 - ordering 36
- power up sequence 11, 32
- project from behind the screen 24

R

- rear projection 24
- remote control
 - replacing the batteries 30
 - using 13, 16
- replacing projection lamp module 27
- re-positioning the image on the screen
 - 22
- resetting adjustments 20
- resolution 1

S

- safety guidelines iii
- SECAM video 19, 23
- security feature 30
- SimulScan, using with PowerBooks 43
- Source button 16
- specifications 35
- Standby button 17
- Standby Time 23
- startup screen 25
- Status menu 26
- S-video
 - connecting 9
 - ordering cable 37

T

- Technical Support
 - information to have on hand
 - before you call 34
- temperature limits 35
- test pattern 31
- text not visible 31
- tint, adjusting 19
- troubleshooting 31
- turning off the projector 12
- turning on the projector 11

U

- USB mouse 8

V

- vertical lines displayed 22, 33
- VESA computer cable 7
- video 19
- video mirroring on a PowerBook 43
- video standards 23
- Volume buttons 17
- volume, adjusting 17, 20

W

- warranty 37

X

- XD-5m
 - cases 36
 - project from behind the screen 24
 - setting up 5
 - specifications 35
 - turning off 12
 - turning on 11

Z

- zooming the image 15

LIMITED WARRANTY

Boxlight ("Boxlight") warrants that each XD-5m ("the Product") sold hereunder will conform to and function in accordance with the written specifications of Boxlight. Said limited warranty shall apply only to the first person or entity that purchases the Product for personal or business use and not for the purpose of distribution or resale. The product may contain recycled components that are in new condition. Said warranty shall continue for a period of two (2) years from the date of such purchase. The standard limited warranty excludes the lamps in projectors after 120 days and the accessories after one year. Boxlight does not warrant that the Product will meet the specific requirements of the first person or entity that purchases the Product for personal or business use. Boxlight's liability for the breach of the foregoing limited warranty is limited to the repair or replacement of the Product or refund of the purchase price of the Product, at Boxlight's sole option. To exercise the Purchaser's rights under the foregoing warranty, the Product must be returned at the Purchaser's sole cost and expense, to Boxlight or to any authorized Boxlight service center provided, however, that the Product must be accompanied by a written letter explaining the problem and which includes (i) proof of date of purchase; (ii) the dealer's name; and (iii) the model and serial number of the Product. When sending your unit in for repair, please ship your unit in its original packing material or a Boxlight approved ATA Shipping Case, or have a professional packaging company pack the unit. Please insure your shipment for its full value. A return authorization number, issued by the Boxlight customer service department, must also be clearly displayed on the outside of the shipping carton containing the Product.

WARRANTY LIMITATION AND EXCLUSION

Boxlight shall have no further obligation under the foregoing limited warranty if the Product has been damaged due to abuse, misuse, neglect, accident, unusual physical or electrical stress, unauthorized modifications, tampering, alterations, or service other than by Boxlight or its authorized agents, causes other than from ordinary use or failure to properly use the Product in the application for which said Product is intended.

DISCLAIMER OF UNSTATED WARRANTIES

THE WARRANTY PRINTED ABOVE IS THE ONLY WARRANTY APPLICABLE TO THIS PURCHASE. ALL OTHER WARRANTIES, EXPRESS OR IMPLIED, INCLUDING, BUT NOT LIMITED TO, THE IMPLIED WARRANTIES OF MERCHANTABILITY AND FITNESS FOR A PARTICULAR PURPOSE ARE DISCLAIMED. THERE ARE NO WARRANTIES THAT EXTEND BEYOND THE FACE HEREOF AND THE FOREGOING WARRANTY SHALL NOT BE EXTENDED, ALTERED OR VARIED EXCEPT BY WRITTEN INSTRUMENT SIGNED BY BOXLIGHT.

LIMITATION OF LIABILITY

IT IS UNDERSTOOD AND AGREED THAT BOXLIGHT'S LIABILITY, WHETHER IN CONTRACT, IN TORT, UNDER ANY WARRANTY, IN NEGLIGENCE OR OTHERWISE, SHALL NOT EXCEED THE RETURN OF THE AMOUNT OF THE PURCHASE PRICE PAID BY PURCHASER AND UNDER NO CIRCUMSTANCES SHALL BOXLIGHT BE LIABLE FOR SPECIAL, INDIRECT OR CONSEQUENTIAL DAMAGES OR LOST PROFITS, LOST REVENUES OR LOST SAVINGS. THE PRICE STATED FOR THE PRODUCT IS A CONSIDERATION IN LIMITING BOXLIGHT'S LIABILITY. NO ACTION, REGARDLESS OF FORM, ARISING OUT OF THE AGREEMENT TO PURCHASE THE PRODUCT MAY BE BROUGHT BY PURCHASER MORE THAN ONE YEAR AFTER THE CAUSE OF ACTION HAS ACCRUED.

Part Number 010-0212-00